

---

**Aus dem Fachgebiet Nutztierethologie und Tierhaltung**  
Fachbereich Ökologische Agrarwissenschaften  
Universität Kassel

## **Cleanliness versus cow comfort – an insolvable problem?**

The influence of cubicle design, management and cow sizes on lying comfort and udder cleanliness in Holstein Friesian dairy cows



Dissertation zur Erlangung des akademischen Grades eines  
Doktors der Agrarwissenschaften (Dr. agr.)

vorgelegt von: Dipl. Ing. agr. Gudrun Plesch

Witzenhausen im Juli 2011

---

This work has been accepted by the faculty of Organic Agriculture of the University of Kassel as a thesis for acquiring the academic degree of 'Doktorin der Agrarwissenschaften'.

Supervisor: Prof. Dr. Ute Knierim

Defence day: 30 August 2011

---

The cows do know and they always tell the truth.

Cows tell us like it is,  
not as we wish it to be,  
not as we perceive it to be,  
not how it once was,  
but how IT IS!

(A. J. Nelson, 1996)

---

## Table of contents

<b>I</b>	<b>List of figures</b>	<b>vi</b>
<b>II</b>	<b>List of tables</b>	<b>vii</b>
<b>III</b>	<b>List of abbreviations</b>	<b>ix</b>
<b>1.</b>	<b>General introduction</b>	<b>1</b>
<b>1.1.</b>	<b>Cow cleanliness</b>	<b>2</b>
<b>1.2.</b>	<b>Resting behaviour</b>	<b>2</b>
<b>1.3.</b>	<b>Cubicle characteristics</b>	<b>4</b>
<b>1.4.</b>	<b>Aims and outline of the thesis</b>	<b>5</b>
<b>2.</b>	<b>How to measure resting comfort?</b>	<b>6</b>
<b>2.1.</b>	<b>Reliability and feasibility of selected measures concerning resting behaviour for the on-farm welfare assessment in dairy cows</b>	<b>6</b>
2.1.1.	Introduction	6
2.1.2.	Animals, material and methods	7
2.1.3.	Results	12
2.1.4.	Discussion	17
2.1.5.	Conclusions	20
<b>2.2.</b>	<b>Further evaluation of different measures of rising and lying down difficulties for the on-farm welfare assessment in dairy cows</b>	<b>21</b>
2.2.1.	Introduction	21
2.2.2.	Materials and Methods	21
2.2.3.	Results	22
2.2.4.	Discussion and conclusion	23
<b>3.</b>	<b>Epidemiological study on udder cleanliness and resting comfort</b>	<b>24</b>
<b>3.1.</b>	<b>Effects of housing and management conditions on teat cleanliness of German Holstein-Friesian dairy cows in cubicle systems taking into account body dimensions of the cows</b>	<b>24</b>
3.1.1.	Introduction	24
3.1.2.	Animals, material and methods	25

---

3.1.3. Results	29
3.1.4. Discussion	35
3.1.5. Conclusion	38
<b>3.2. Effects of cubicle characteristics in relation to cow body size on lying down behaviour in German Holstein dairy cows</b>	<b>40</b>
3.2.1. Introduction	40
3.2.2. Animals, material and methods	41
3.2.3. Results	42
3.2.4. Discussion	43
3.2.5. Conclusions	45
<b>3.3. Relationship between lying down behaviour, cubicle characteristics and udder hygiene</b>	<b>46</b>
3.3.1. Introduction	46
3.3.2. Animals, materials and methods	46
3.3.3. Results	47
3.3.4. Discussion	49
3.3.5. Conclusion	51
<b>4. General discussion</b>	<b>52</b>
<b>5. Conclusion</b>	<b>56</b>
<b>6. Summary</b>	<b>57</b>
<b>7. Ausführliche Zusammenfassung</b>	<b>60</b>
<b>8. References</b>	<b>66</b>

---

## I List of figures

Figure 1:	Durations of 'lying down' and ratios of 'lying down events with at least one collision'/all lying down events and of cows lying 'partly or completely outside lying area'/all cows lying (LSmeans) subject to housing system, country and day of visit and standard error as well as results from analyses of variance	16
Figure 2:	Teat cleanliness scoring scheme	26
Figure 3:	Schematic view of cubicle dimensions that were assessed during the farm visit with description of cubicle measures.	27
Figure 4:	Box plots of height at withers for all study farms with whiskers with maximum 1.5 IQR and outliers (points)	30
Figure 5:	Box plots of diagonal body length for all study farms with whiskers with maximum 1.5 IQR and outliers (points)	31
Figure 6:	Box plot for durations of lying down per farm (n=24) with whiskers with maximum 1.5 IQR and outliers (points) and extreme outliers (asterisks)	42
Figure 7:	Mean duration of lying down, percentage of events with at least one collision during lying down and percentage of interrupted events per farm (n=24)	43

---

## II List of tables

Table 1:	Ethogram around rising and lying down, definitions and calculation of measures	9
Table 2:	Ethogram of lying positions and other behaviours around resting assessed by instantaneous scan sampling, definitions and calculation of measures	10
Table 3:	Mean frequencies of normal and abnormal rising and lying down per hour of farm visit and ratio of occurrences to all lying down or rising events (in percent) (n=35 farms * 3 visits)	12
Table 4:	Proportion of lying animals per all animals in pen and ratio of number of cows in specific positions to all cows lying (in percent) per scan (n=35 farms * 3 visits * 4 hours <sup>1</sup> )	13
Table 5:	Inter-observer reliability (IOR) and consistency of results over time concerning different measures around resting: IOR between two observers in different test situations - live on farm, from videos or photos, either before (pre-testing) or after data recording (post-testing, in italics) expressed as Spearman rank correlation coefficient ( $r_s$ ) or Prevalence Adjusted Bias Adjusted Kappa (PABAK); consistency over time (across days 1, 60 and 120 in tie stalls or 180 in loose housing) expressed as Kendall's correlation coefficient W	14
Table 6:	Consistency over time for behavioural measures using Kendall's coefficient of concordance (W).	22
Table 7:	Calculations of correlations between consistent measures, using Spearman rank correlation coefficient ( $r_s$ ) over all farms (n=35).	22
Table 8:	Recommendations for cubicle dimension according to Bartussek <i>et al.</i> (2008) considering body dimensions, namely height at withers (HW) and diagonal body length (DBL).	28
Table 9:	Compliance of cubicle measures with recommendations for the 25 % tallest cows in the herd (n=23).	30

- 
- Table 10: Correlations between different hygiene scores with regard to specific udder areas on cow level (n=1171). Spearman's rank correlation coefficient ( $r_s$ ) for udder score, mean teat score, proportion of dirty teats (teats scored 2 or 3 per all assessed teats) and the proportion of dirty teat tips (dirty teat tips per all scored teats). 32
- Table 11: Correlation between cleanliness measures and cubicle characteristics using Pearson Correlation Coefficient ( $r_P$ ) and point biserial correlation coefficient ( $r_{pb}$ ). 33
- Table 12: Final model of stepwise regression (PROC REG stepwise, SAS 9.2) with the dependent variable 'percentage of dirty and very dirty teats' including 17 independent variables (n=23). 34
- Table 13: Final model of stepwise regression (PROC REG stepwise, SAS 9.2) with the dependent variable 'percentage of dirty teat tips' including 14 independent variables (n=23). 34
- Table 14: Predictors for inclusion in regression model 'impaired lying down' using Pearson Correlation Coefficient ( $r_P$ ) and point biserial correlation coefficient ( $r_{pb}$ ). 47
- Table 15: Final model of stepwise regression (PROC REG stepwise, SAS 9.2) with the dependent variable 'percentage of impaired lying down' including 13 predicting variables (n=23). 48



### III List of abbreviations

ACTH	adrenocorticotropic hormone
BMELV	Bundesministerium für Ernährung, Landwirtschaft und Verbraucherschutz
CIGR	Commission International du Genie Rural
cm	centimetre
DBL	diagonal body length
e.g.	for example
EFSA	European Food Safety Authority
et al.	et alii (and others)
EU	European Union
HW	height at withers
IOR	inter-observer reliability
IQR	inter-quartile range
LSmeans	Least square means
m	meter
min	minutes
n	sample size
ns	not significant
PABAK	Prevalence adjusted bias adjusted kappa
$r_p$	Pearsons correlation coefficient
$r_{pb}$	point biserial correlation coefficient
$r_s$	Spearman's rank correlation coefficient
SD	standard deviation
sec	seconds
vs.	versus
W	Kendall's coefficient of concordance
%	percent
±	plus/minus
<	less than/below
>	more than/above

## 1. General introduction

Germany is the largest milk producer in the European Union and production is still increasing (BMELV, 2009). At the end of 2010 on in total 91,550 German dairy farms around 4.2 million cows were kept (Statistisches Bundesamt, 2011). Milk is the most important animal product contributing to about 40 % of all sales revenues from animal production (BMELV, 2009). Almost half of the German cows under milk control belong to the Holstein breed, including Black and White (Holstein) as well as Red and White cows (Red Holstein) (Deutscher Holstein Verband e.V., 2007). This breed exhibits a high genetic potential for milk production. To make full use of this potential whilst keeping the cows healthy, particular attention needs to be paid to feeding and housing conditions.

Already starting in the 1960s (e.g. Harrison, 1964), a public debate on animal welfare is going on nationally and internationally, especially with regard to intensive housing systems. Over the last years increased public concern is reflected by a growing body of welfare legislation and the call for more information about welfare conditions of farm animals by EU citizens (Eurobarometer, 2007). However, to date there is no specific welfare legislation concerning dairy cows, although the European Food Safety Authority recently asked the Panel on Health and Welfare for a scientific opinion on the overall effects of farming systems on dairy cow welfare and disease which was submitted in 2009 (EFSA, 2009). Concurrently, farmers increasingly became aware of the fact that improved dairy cow comfort, i.e. welfare, can increase production (e.g. Brandes, 2000; Bergmann et al., 2000; Bergmann and Heuwieser, 2000). Welfare includes behavioural and health aspects (e.g. Dawkins, 2004). Providing good welfare in terms of behaviour is not always accompanied by good health. Straw yards for example allow for largely unimpaired resting related behaviour (Phillips and Schofield, 1994; Haley et al., 2001), but at the same time may constitute a risk for udder health due to soiling and therefore a high load of environmental pathogens (Schreiner and Ruegg, 2003; Reneau et al., 2005). Together with fertility problems udder health is the most important reason for culling dairy cows (Brade, 2005). Mastitis comes along with decreasing milk yield, expenses for medical treatment and further economic losses through cut-offs for medicated milk (Fetrow et al., 1991; Shim et al., 2004). In order to reduce udder soiling and work load around litter provision and management, cubicle housing was introduced. It is the most common loose housing system today and likely in the future. In Germany in total 72 % of the dairy cows are kept in loose housing systems (Statistisches Bundesamt, 2011). Barns with solid manure only cover 10 % of all loose housing system, whereas 62 % are slurry-based system, which presumably corresponds to

the amount of cubicle housing (Statistisches Bundesamt, 2011). In a survey conducted by Hörning et al. (2004) around 2/3<sup>rd</sup> of all organic dairy farms were using cubicle housing systems. Cubicle design is constantly further developed and while trying to improve cow comfort, cleanliness must still be kept at good levels.

### **1.1. Cow cleanliness**

Ensuring good dairy cow hygiene decreases the risk for udder health problems (Osteras and Lund, 1988; Schukken et al., 1990; Schreiner and Ruegg, 2003; Reneau et al., 2005) and reduces teat cleaning time prior to milking (Bernardi et al., 2009). Cow cleanliness in cubicle housing systems is affected by multiple factors. Among them are cubicle characteristics such as neck rail position or cubicle surface (Chaplin et al., 2000; Tucker et al., 2004; Tucker and Weary, 2004; Fulwider et al., 2007; Bernardi et al., 2009; Fregonesi et al., 2009). For instance, generous dimensions allow the cows to stand in the cubicle, increasing the risk for soiling due to defecation whilst standing. Therefore, especially smaller cows within the herd are suspected to largely contribute to cubicle soiling. However, also management related factors were found to influence cubicle as well as udder soiling, for instance type and amount of bedding, frequency of replacement or passageway soiling (Christiansson et al., 1999; Norring et al., 2008; Magnusson et al., 2008). Additionally, lying partly or completely outside the lying area is suspected to decrease cleanliness. Cubicle refusal (lying in the alley) is among others associated with rearing conditions of heifers (Kjoestad and Myren, 2001) and overcrowding situations (Wierenga and Hopster, 1982). Although at pasture cows show faeces avoidance behaviour (Aland et al., 2002, this becomes more difficult in the housing situation and there is evidence that - compared to straw yards - cubicle housing design negatively affects elimination-avoidance behaviour as cows can hardly avoid contact with faeces during lying if cubicles are soiled (Whistance et al., 2007).

### **1.2. Resting behaviour**

Similarly important for dairy cow welfare is resting comfort (Welfare Quality<sup>®</sup> Consortium, 2009). Drowsing, resting and sleeping in cattle occur in a recumbent position (Fraser and Broom, 1990). On average cows spend between 40 and 60 % of the day in this state (Ruckebusch, 1972; Wierenga and Hopster, 1990a; Krohn and Munksgaard, 1993), with rumination taking place during half of that time (Krohn and Munksgaard, 1993; Shuji and Ito, 1999; Fournier, 2003). Total daily resting time in cows is normally divided in 6.5 – 14 bouts lasting about 68 - 80 minutes each (Arave and Walters, 1980; Haley et al., 2000).

Lying - in comparison to standing - allows relief and accelerated drying of the claws and increases the uterine (Nishida et al., 2004) as well as the mammary blood flow

(Rulquin and Caudal, 1992). The latter is important for milk performance, even though no effect of lying deprivation on milk yield was found yet (Cooper et al., 2008). A repeated deprivation from lying significantly increased concentrations of the adrenocorticotrophic hormone (ACTH), which points towards an aversive response (Munksgaard and Simonsen, 1996). It also induces behaviours that are indicative of discomfort and frustration (Cooper et al., 2008), namely leg stamping, repositioning and weight shifting. When considering the average daily recumbency time of ten to 14 hours daily (Ruckebusch, 1972; Wierenga and Hopster, 1990a; Krohn and Munksgaard, 1993; O'Driscoll et al., 2009), the importance of resting comfort in dairy cows becomes apparent. Resting time was found to be substantially influenced by the type of pen or stall; as the average total lying time in cubicle houses was 14.7 hours per day in 13.6 bouts and 10.5 hours in 8.2 bouts in tie-stalls (Haley et al., 2000). Cows prefer dry (Fregonesi et al., 2007b; Reich et al., 2010) and soft lying surfaces (Calamari et al., 2009) with low friction. The spatial demands during lying vary considerably depending on lying positions. They range from the space-saving sternal position, usually adopted during rumination, to very space-consuming positions such as fully lying on the side (Fraser and Broom, 1990). Furthermore, enough space should be provided for lying down and rising. Lying down comes along with a high lateral displacement of the cow's body, whereas getting up movements require expansive forward lunging space (Kämmer and Schnitzer, 1975; Ceballos et al., 2004). Undisturbed lying down is normally displayed as one quick and consecutive movement (Krohn and Munksgaard, 1993). Disturbances of resting may for example take the form of lying deprivation (Cooper et al., 2008), prolonged lying down or rising (Martiskainen et al., 2007) or collisions with housing equipment (Blom et al., 1984; Hörning, 2003a; Veissier et al., 2004). They are associated with aversive or even painful experiences and e.g. may lead to injuries (Wechsler et al., 2000; Fulwider et al., 2007; Martiskainen et al., 2007; Norring et al., 2008) or higher lameness incidences and prevalences (Faull et al., 1996; Howell et al., 2003) which again may be painful or impair mobility. Thus, disturbances of resting may be highly welfare relevant.

Indeed, the commonly used term 'cow comfort' in cattle practice to a large degree refers to a lying area that is adapted to the cow's needs.

As resting comfort has many aspects, as explained above, it can be assessed in many ways. The different measures may or may not be inter-related. Previously used measures are e.g. the total lying time (Haley et al., 2000; Fregonesi and Leaver, 2001), lying bout duration (Haley et al., 2000), frequency of lying and the duration of lying down or rising (Hörning, 2003a). Furthermore different lying positions were investigated (Krohn and Munksgaard, 1993; Haley et al., 2000; Hörning, 2003a).

### 1.3. Cubicle characteristics

Cubicles are a central element of the cow's environment, influencing resting comfort, cleanliness and health (CIGR, 1994). While they are relatively easy to maintain, require few or no litter and provide sheltered lying space even for low ranking cows (Wierenga and Hopster, 1990a; Tucker et al., 2005), they also pose some challenges.

Among them are how to achieve an adequate cubicle adjustment that allows sufficient behavioural freedom in relation to cow sizes, which can vary considerably within the herd (Bockisch, 1991; Fregonesi et al., 2009), provision of a soft but durable lying surface and prevention from soiling.

The impact of various cubicle characteristics on lying behaviour, cleanliness and health, respectively, were demonstrated by a number of experimental and epidemiological studies. Among these characteristics are: neck rail positioning (Tucker et al., 2005; Bernardi et al., 2009; Fregonesi et al., 2009), presence of a brisket board (Tucker et al., 2006), partition design (O'Connell et al., 1992; Veissier et al., 2004), cubicle flooring (Herlin, 1997; Chaplin et al., 2000; Tucker et al., 2003; Wagner-Storch et al., 2003; Fulwider et al., 2007; Norring et al., 2008), bedding type or amount (Hörning, 2003a; Drissler et al., 2005; Reich et al., 2010) and cubicle width or length (Tucker et al., 2003; Howell et al., 2003; Keil et al., 2003).

Inadequate cubicles, in terms of narrow dimensions, restrictive partitions and hard flooring account for behavioural (Wierenga and Hopster, 1990a; Hörning, 2003a) or certain health problems (Kämmer and Schnitzer, 1975) such as lameness (Dippel et al., 2009a; Dippel et al., 2009b) and lesions (Fulwider et al., 2007). However, on the other hand, generous cubicle dimensions were found to be associated with impaired udder and cubicle hygiene due to defecation and urination (Tucker et al., 2004; Tucker et al., 2005), increasing the risk of mastitis (Schreiner and Ruegg, 2003) and extending cubicle maintenance or udder cleaning time (Bernardi et al., 2009).

This disagreement between recommendations for cubicle dimensions concerning resting comfort and cleanliness was often mentioned in literature, but hardly any study specifically investigated both resting comfort and udder cleanliness. Moreover, one important aspect, namely the interaction between cubicle and cow dimensions, was only rarely taken into account. Resting length, width, head space and total length of the cubicle as well as the neck rail position need to be adapted to the height at withers and diagonal body length of the cows.

Bockisch (1991) reported that a difference of 30 cm and more in diagonal body length within a herd can be considered as normal. These variations are likely mainly due to breed or the age of the cow. Nevertheless, the cubicles should provide an adequate resting area even for the largest animals in herd (CIGR, 1994). Already Troxler et al. (1987) pointed out the importance of a continuous review of

recommendations for cubicle dimensioning, since current breeding goals are leading to increases in cow sizes and changes in body proportions over time.

#### **1.4. Aims and outline of the thesis**

It was the aim of this thesis to find out which factors in the complex farm situation predominantly affect resting comfort or teat cleanliness or both and whether their effects would act in opposite directions or not. Moreover, the relationship of cleanliness and resting comfort levels per farm was analysed directly. Based on the results, recommendations should be derived how to improve dairy cow welfare in cubicle houses while taking into account the two apparently conflicting goals. However, before adopting this epidemiological approach, it was necessary to define how resting comfort can be reliably measured in a feasible way in the framework of an on-farm investigation. This was done on a different set of farms, not only with cubicle systems, but also with tie stalls and deep litter systems in order to ensure a greater variation regarding presumed levels of resting comfort.

Therefore, the thesis comprises the development of the resting comfort measures in two parts and the epidemiological study involving two major parts, one focusing on different hygiene measures and the other dealing with resting behaviour, both in relation to management and housing factors under consideration of the body dimensions of the cows. The thesis is then concluded by a general discussion and some recommendations for future work and for the practice.

## 2. How to measure resting comfort?

### 2.1. Reliability and feasibility of selected measures concerning resting behaviour for the on-farm welfare assessment in dairy cows

#### 2.1.1. Introduction

In dairy cows resting mainly occurs while lying, and this is a high priority behaviour (Munksgaard et al., 2005). Cows may spend up to 14 hours per day lying (Wierenga and Hopster, 1990b) with about half of the resting period ruminating (Shuji and Ito, 1999; Fournier, 2003). Disturbances of resting may be associated with insufficient recuperation, frustration (Munksgaard and Simonsen, 1996), experience of discomfort or pain and increased risks for health problems such as lameness (Singh et al., 1994; Faull et al., 1996; Howell et al., 2003) or lesions (Wechsler et al., 2000; Norring et al., 2008).

A number of different measures around resting have been used in past studies. For instance, total lying time (Haley et al., 2000; Fregonesi and Leaver, 2001), number of lying bouts and bout duration (Haley et al., 2000) have been evaluated as appropriate welfare indicators. However, they cannot be recorded within short-term observations and are therefore unsuitable for the purpose at hand. More suitable candidate measures relate to lying down and rising (Lidfors, 1989), different lying positions (Kämmer and Schnitzer, 1975) including standing on the lying area (Cook et al., 2005) and synchrony of lying (Bock, 1990).

Lying down and rising have been measured semi-quantitatively using scoring systems (e.g. Chaplin and Munksgaard, 2001; Whay et al., 2003) or quantitatively by recording durations and counting deviations from the normal sequence of movements such as horse-like rising, lying down with hind quarters first and interrupted movements (e.g. Krohn and Munksgaard, 1993; Wechsler et al., 2009; Hörning, 2003). Additionally, potentially aversive, painful or injurious occurrences have been recorded such as hitting against fittings (Kämmer, 1981; Hörning, 2003a; Veissier et al., 2004) or slipping (Wechsler et al., 2000).

Lying in a relaxed position such as lying on side, head on ground or hind leg extended (Kämmer and Schnitzer, 1975; Krohn and Munksgaard, 1993; Haley et al., 2000; Hörning, 2003a) may be an indicator of good welfare (Winckler et al., 2003). On the other hand, lying over a curb or on the edge of the lying area (Cermak, 1988; Bock, 1990) or partly or completely outside the lying area, i.e. on alleys or exercise yards (Wierenga and Hopster, 1990b; Capdeville and Veissier, 2001) is associated with discomfort or pain, as well as increased risks of soiling (Sunderland, 2002; Howell et al., 2003) and injuries (Phillips, 2002). High proportions of cows standing

on the lying area may reflect difficulties in lying down, or associated with lying down uncomfortable lying surfaces (Haley et al., 2001; Tucker et al., 2003), but probably also problems with lameness (Cook et al., 2005) and cubicle surfaces especially suitable for standing (Tucker et al., 2003).

Synchrony of lying might be more related to social than to resting behaviour. It has been proposed that a decrease means a certain frustration of allelomimetic behaviour (Miller and Woodgush, 1991; Krohn et al., 1992). It may be measured as duration of all cows lying at the same time (Fregonesi and Leaver, 2001) which again is not feasible for an on-farm welfare assessment, or as maximum number of simultaneously lying cows which often has been counted from a limited number of instantaneous scan samples (Bock, 1990; Hörning, 2003a).

Only very few resting studies have addressed the quality criteria of measurements: inter-observer reliability (e.g. Chaplin and Munksgaard, 2001) and repeatability (consistency) over time (Rousing et al., 2001). Sometimes figures are not provided although reliability testing is reported (e.g. Veissier et al. 2004).

The aim of this investigation was to evaluate welfare measures relating to dairy cow resting behaviour in terms of their suitability for inclusion in an on-farm assessment protocol. Criteria of suitability were (i) feasibility with respect to limited observation times, (ii) sufficient inter-observer reliability and (iii) repeatability over time. In addition, we wanted to know the degree to which the measures allowed discrimination between different housing systems that were expected to provide different levels of resting comfort.

## **2.1.2. Animals, material and methods**

### **2.1.2.1. *On-farm data collection***

Resting behaviour was observed on a total of 35 dairy farms, 17 in Austria and 18 in Germany, between August 2005 and April 2006. The farms either had cubicle systems (16 farms), deep litter including sloped floor with straw bedding (7 farms) or tie stalls (12 farms). Average herd size was about 37 lactating cows (SD: 22.2, range: 12-100), sporadically including dry cows and heifers in loose housing systems. Each farm was visited three times in order to investigate short-, medium-, and long-term consistency of resting measures within farms. The second and the last visit took place 60 and 180 days ( $\pm 10$  days; one farm on day 227 instead of 180) after the first data collection. Due to organisational reasons, the last visit in tie stalls was on day 120 ( $\pm 10$  days). Housing and management conditions were recorded on the basis of inspections and interviews using a standardised check sheet and questionnaire. Any changes between visits were noted. On the recording days none of the farms provided access to pasture.



Behavioural observations started after morning milking or when at least 75 % of the loose housed cows had returned to the pen from morning milking or, if the cows were usually locked after milking, five minutes after release from the feed rack. Observations lasted about 4 hours and were carried out by one person per farm positioned on the feeding passage on an elevated moveable chair. Dry, periparturient and sick cows kept in separate pens were not observed. Behavioural recording, of in total 15 measures (Table 1), included measurement of the duration of voluntary rising and lying down events whenever they visibly occurred using a stop watch (for exact definitions see Table 1). Additionally, collisions with the housing equipment, slipping, or abnormal occurrences (Table 1) during the recorded rising and lying down events were counted. It was intended to record these measures from 20 rising and 20 lying down events, therefore observation time was extended on some farms, at maximum to 8 hours, in order to converge on the intended limit. Numbers of standing and lying animals in specified lying positions (Table 2) were recorded by instantaneous scan sampling. Due to concurrent observations of social interactions that are not reported here, if necessary, pens were split up into virtual segments that were expected to contain on average not more than 25 cows. However, additional segments were sometimes necessary when not all animals could be observed at the same time due to obstructions by equipment or the building, so that the maximum number of segments was nine. Scan sampling was carried out every 14 to 30 minutes per segment depending on the number of virtual segments. In case of no division of the pen, the scan interval for the whole pen was 30 minutes.

**Table 1: Ethogram around rising and lying down, definitions and calculation of measures**

<b>Name of measure</b>	<b>Description</b>	<b>Unit</b>
Rising	Event starts when the animal starts lifting the hind quarter from the ground. The rising sequence ends when both front legs touch the ground and the cow stands with her whole body weight on all four legs again.	<i>Duration in seconds</i>
Lying down	Event starts when one carpal joint of the animal is bent (before touching the ground). The whole lying down sequence ends when the hind quarter of the animal has fallen down and the cow has pulled the front legs out from underneath the body.	
Collision	During rising or lying down the animal hits against housing equipment with any part of the body.	<i>Ratio of specific events /all lying down or rising events</i>
Slipping	During rising or lying down at least one claw or leg is accidentally sliding abruptly out of place.	
Interrupted	The sequence of lying down or rising is not finished by the animal	
Horse-like rising	Animal gets up with its outstretched front legs first.	
Hind quarter first	Animal lies down with its hind legs first and bends the front legs afterwards.	

**Table 2: Ethogram of lying positions and other behaviours around resting assessed by instantaneous scan sampling, definitions and calculation of measures**

<b>Name of measure</b>	<b>Description</b>	<b>Unit</b>
Partly or completely outside lying area <sup>1</sup>	Animal lies with a considerable part of its hind quarter or the whole body outside the supposed lying area (cubicle or littered area)	
Head resting	Animal is lying with its head positioned in a relaxed way in contact either with the floor, housing equipment or its own body.	
Hind leg stretched	Animal lies with at least one of its hind legs stretched away from its body at an angle of $\geq 90$ .	<i>Ratio of number of cows in specific lying (sitting)position/all cows lying</i>
On side	Animal lies in lateral position with whole body weight put on one side and legs not underneath the body, either stretched or bent.	
Sitting	Animal sits dog-like on its hind quarter with front legs fully stretched. Sitting animals are generally included into 'lying' for the calculation of the measures	
Backwards	Animal lies backwards in the cubicle with head at the position where the hind quarter is supposed to be - only for cubicle systems.	
Synchrony of lying	The maximum proportion of animals lying simultaneously (when multiple segments were observed, the value was calculated from the total number of cows in the segments observed).	<i>Maximum number of lying animals/all animals per pen</i>
Standing on lying area	Animal is standing in cubicle or on littered area (only in cubicle housing and deep litter system) with at least two legs	<i>Ratio of cows standing on lying area/all cows on lying area (lying and standing)</i>

<sup>1</sup>This behavioural category was originally recorded as three behaviours: 'hind quarter on edge', 'hind quarter out of lying area' and 'completely outside lying area', but merged after recording for logical reasons. Lying completely outside lying area did not occur in tie stalls.

### **2.1.2.2. Inter-observer reliability testing**

Inter-observer reliability (IOR) between two observers with initially only limited training was tested during four sessions, two of them before the start of data recording (pre-testing), two of them 310 and 400 days after the start of the farm visits (post-testing). Test sessions were performed on five farms and from videos and photographs which had been taken during farm visits from about the same position as for the on-farm observations. They showed one or several animals kept in different housing conditions. In total pre-testing included 27 rising and 13 lying down events (on-farm), 34 lying down events (on video) and 20 scans of lying positions with 51 lying animals in total (on-farm). Post-testing comprised 8 rising and 21 lying down events (on-farm), 65 lying down events (on video) and, with regard to lying positions, 30 scans with 35 lying animals in total (on-farm) and 57 photographs with altogether 76 lying animals (one or more animals per picture).

### **2.1.2.3. Selection of measures in terms of feasibility and reliability**

A stepwise approach was taken in order to evaluate the suitability of the measures for an on-farm welfare assessment protocol. First, we considered that the frequency or proportion of recordings of different measures had to reach a certain minimum within a given observation time in order to limit the effect of chance observations and to allow for a reliable differentiation between farms. In the absence of any empirical basis we chose the arbitrary limit that all behavioural events should occur on average with a minimum incidence of 1.0 per hour and farm. With regard to lying (sitting) positions a minimum of 1 % of lying animals should be observed in this position per average scan. The same applied for animals standing on the lying area in relation to all cows present on the lying area. Second, acceptable IOR had to be reached. Third, measures should yield sufficiently consistent results per farm over time. Finally, for measures found to be reliable and consistent, reduced observation times were simulated from four to one hour units in one hour steps and checked again for intra-farm consistency.

As a further basis for evaluation, though not for selection, analyses of variance were performed to test for the effect of housing system and country. We also examined variation within farms over time in relation to variation between farms.

### **2.1.2.4. Statistics**

IOR was tested using 'Spearman's rank correlation coefficient  $r_s$ ' for two observers in the case of continuous data and 'Prevalence Adjusted Bias Adjusted Kappa' (PABAK) (Abramson, 2003) for dichotomous data (Byrt et al., 1993). Correlation coefficients were interpreted in line with Martin and Bateson (2007) as acceptable in terms of IOR if they were greater than 0.70. Similarly to the interpretation of Kappa-

Values (Fleiss et al., 2003), a PABAK of 0.75 was regarded as excellent inter-observer agreement.

Consistency of results within farm over time was examined using 'Kendall's coefficient of concordance  $W$ ', again applying the threshold of 0.70.

Analyses of variance were performed using the PROC MIXED procedure in SAS Version 9.1 (SAS Institute) with 'day (of visit)' ( $\alpha_i$ , i.e. day 1, 60 or 180/120), 'housing system' ( $\beta_j$ ), 'country' ( $\gamma_k$ ) and the interaction 'housing system\*country' ( $\beta_j*\gamma_k$ ) as fixed effects. Multiple farm visits were accounted for by inclusion of 'farm' ( $b_l$ ) as subject in the REPEATED statement. This resulted in a model of the form:  $y_{ijkl} = \mu + \alpha_i + \beta_j + \gamma_k + \beta_j*\gamma_k + b_l + \varepsilon_{ijkl}$ .

Comparison of within- and between-farm variability of parameters was carried out using covariance parameter estimates for the farm and the residual component.

### 2.1.3. Results

#### 2.1.3.1. Frequencies or proportions of recordings

It was often not possible to record the intended number of 20 rising occurrences within the observation time of 4 hours while this was no problem for the lying down events. Collisions with equipment during rising or lying down occurred more often than slipping which was very rarely observed (Table 3). Only 'rising', 'lying down' and 'collisions during lying down' occurred more than once per hour of observation (Table 3). On average 47.3 % of all cows were lying during scan sampling. Regarding different lying positions, the mean proportions of cows lying with 'head resting', with 'hind legs stretched', 'on side' and 'lying partly or completely outside lying area' exceeded 1 % per scan (Table 4). All other measures were, therefore, excluded from further analysis.

**Table 3: Mean frequencies of normal and abnormal rising and lying down per hour of farm visit and ratio of occurrences to all lying down or rising events (in percent) (n=35 farms \* 3 visits)**

	Normal sequences			Abnormal sequences			
	Total	Collisions	Slipping	Total	Interrupted	Horselike	Hind quarter first
Frequency rising	<b>4.05</b>	0.93	0.04	0.28	0.04	0.23	n.a.
Ratio rising	93.65	21.58	0.92	6.35	1.03	5.32	n.a.
Frequency lying down	<b>6.66</b>	<b>1.78</b>	0.02	0.16	0.12	n.a.	0.04
Ratio lying down	97.67	26.18	0.27	2.33	1.82	n.a.	0.51

Figures in bold exceed threshold of 1.0 occurrence/hour; n.a. = not applicable

**Table 4: Proportion of lying animals per all animals in pen and ratio of number of cows in specific positions to all cows lying (in percent) per scan (n=35 farms \* 3 visits \* 4 hours<sup>1</sup>)**

	Lying animals	Standing on lying area <sup>2</sup>	Head resting	Hind leg stretched	On side	Sitting	Backwards <sup>3</sup>	Partly or completely outside lying area
Ratio	<b>47.33</b>	<b>12.95</b>	<b>8.49</b>	<b>16.03</b>	0.44	0.01	0.00	<b>13.33</b>

<sup>1</sup>No scan results available for 3<sup>rd</sup> and/or 4<sup>th</sup> hour on two farms.

<sup>2</sup>Only applied in loose housing systems (n=23); ratio to all cows present on lying area

<sup>3</sup>Only applied in cubicle housing (n=16)

Figures in bold exceed threshold of 1

### **2.1.3.2. Inter-observer reliability (IOR)**

All measures further examined met the criteria for acceptable inter-observer agreement, except 'collisions' with the equipment during lying down, and lying with 'head resting', both during live observations. However, results from videos or photos, respectively, were acceptable. For collisions, the definition had been refined before observing the video tapes (Table 5). Some measures could not be observed and IOR assessed during every test session, but at least some observations were available for all measures (Table 5).

**Table 5: Inter-observer reliability (IOR) and consistency of results over time concerning different measures around resting: IOR between two observers in different test situations - live on farm, from videos or photos, either before (pre-testing) or after data recording (post-testing, in italics) expressed as Spearman rank correlation coefficient ( $r_s$ ) or Prevalence Adjusted Bias Adjusted Kappa (PABAK); consistency over time (across days 1, 60 and 120 in tie stalls or 180 in loose housing) expressed as Kendall's correlation coefficient W**

Measure	Inter-observer reliability				Consistency over time
	Live		Videos/Photos		
	n	$r_s$	n	$r_s$	W
Duration of lying down	13	<b>0.98**</b>	34/0	<b>0.85**</b>	<b>0.78***</b>
	21	<b>0.98**</b>	65/0	<b>0.95**</b>	
Duration of rising	27	<b>0.84**</b>	-	-	<b>0.74***</b>
	8	<b>0.83**</b>	-	-	
Collisions during lying down	15 <sup>1</sup>	<i>PABAK = 0.20</i>	65/0	<i>PABAK = 0.78<sup>2</sup></i>	<b>0.95***</b>
Partly or completely outside lying area	20	not seen	-	-	<b>0.87***</b>
	30	<i>not seen</i>	0/57	<b>0.80**</b>	
Lying (basis for calculation of synchrony of lying)	20	<b>0.99**</b>	-	-	0.54* (synchrony of lying)
	30	<b>1.00**</b>	0/57	<b>1.00**</b>	
Standing on lying area	20	<b>0.99**</b>	-	-	0.65**
	30	<b>1.00**</b>	0/57	<i>not seen</i>	
Head resting	20	<b>0.99**</b>	-	-	0.60**
	30	<i>0.67*</i>	0/57	<b>0.95**</b>	
Hind legs stretched	20	<b>1.00**</b>	-	-	0.63**
	30	<b>0.81**</b>	0/57	<b>0.82**</b>	

<sup>1</sup> Collisions had not been recorded during pre-testing

<sup>2</sup> After revision of definition from 'hit' to 'forceful hit'

\* $p < 0.05$ , \*\* $p < 0.01$ , \*\*\* $p < 0.001$ ; figures in bold exceed threshold of  $r_s$  or W/PABAK=0.70/0.75

### 2.1.3.3. Consistency over time

The various behaviours that were observed on successive farm visits differed in their consistency over time (Table 5). Mean duration of 'lying down' and 'rising', percentages of 'collisions' and percentages of animals lying 'partly or completely

outside the lying area' exceeded the criterion for sufficient consistency of results over time (Table 5).

With respect to variability among hours we simulated a reduction of observation time for the proportion of cows 'lying partly or completely outside lying area' by only taking the first or the last 2 hours of the 4 hour observation period into account. Consistency even slightly increased when the first 2 hours were selected and decreased for the last 2 hours of observation, still showing significant results with  $W$  above 0.7 ( $W=0.88$  and  $0.80$  respectively;  $n=35/33$ ;  $p<0.001$ ).

Reduction of observation time was also simulated based on the frequencies of observations of rising and lying down events obtained during the first 4 hours of observation. For rising this meant that 12 observed occurrences within four hours were expected to decline to 3 occurrences within one hour. For lying down, 24 occurrences were expected within four hours decreasing to six observations during one hour.

Consistency over time for 'rising' (mean duration) based on these numbers of observations was consistently below  $W$  of 0.70 ( $W=0.39$ ;  $0.56$ ;  $0.67$ ;  $0.68$  for 1, 2, 3 and 4 hours simulated observation time;  $n=35$ , n.s.;  $p<0.01$ ;  $p<0.001$ ;  $p<0.001$ ). For similar simulations for 'lying down' (mean duration) consistency over time remained acceptable ( $W=0.72$ ;  $0.74$ ;  $0.76$ ;  $0.78$ ;  $n=35$ ,  $p<0.001$ ). The same was true for percentages of 'collisions' during lying down ( $W=0.88$ ;  $0.93$ ;  $0.94$ ;  $0.94$ ;  $n=35$ ,  $p<0.001$ ). When, for percentages of cows lying 'partly or completely outside lying area', only the first two or the second two observation hours were considered, results from the three farm visits showed a correlation of  $W = 0.88$  and  $0.80$ , respectively ( $n=35$ ;  $n=33$ ;  $p<0.001$ ).

#### **2.1.3.4. Analysis of variance**

Significant effects of the housing systems were found for all three measures further examined: duration of 'lying down' ( $F=14.59$ ,  $p<0.0001$ ), percentage of 'collisions during lying down' ( $F=52.51$ ,  $p<0.0001$ ) and percentage of cows lying 'partly or completely outside lying area' ( $F=73.46$ ,  $p<0.0001$ , Figure 1). 'Country' significantly affected percentages of 'collisions during lying down' ( $F=174.78$ ,  $p<0.0001$ ) and percentage of cows lying 'partly or completely outside lying area' ( $F=14.36$ ,  $p<0.001$ ), but not duration of 'lying down' ( $F=0.03$ ,  $p=0.87$ , Figure 1). At the same time there was a significant effect of the interaction 'housing system\*country' on 'collision during lying down' and 'partly or completely outside lying area' ( $F=35.54$ ,  $F=16.83$ ,  $p<0.0001$ ), but not on 'lying down' ( $F=1.76$ ,  $p=0.19$ , Figure 1). Regarding the 'day of visit' no significant systematic effect, e.g. due to season, was found for 'lying down' and 'partly or completely outside lying area' ( $F=0.26$ ,  $p=0.77$ ;  $F=1.66$ ,  $p=0.20$ ), but there was an effect for 'collisions during lying down' ( $F=5.36$ ,  $p<0.01$ , Figure 1).



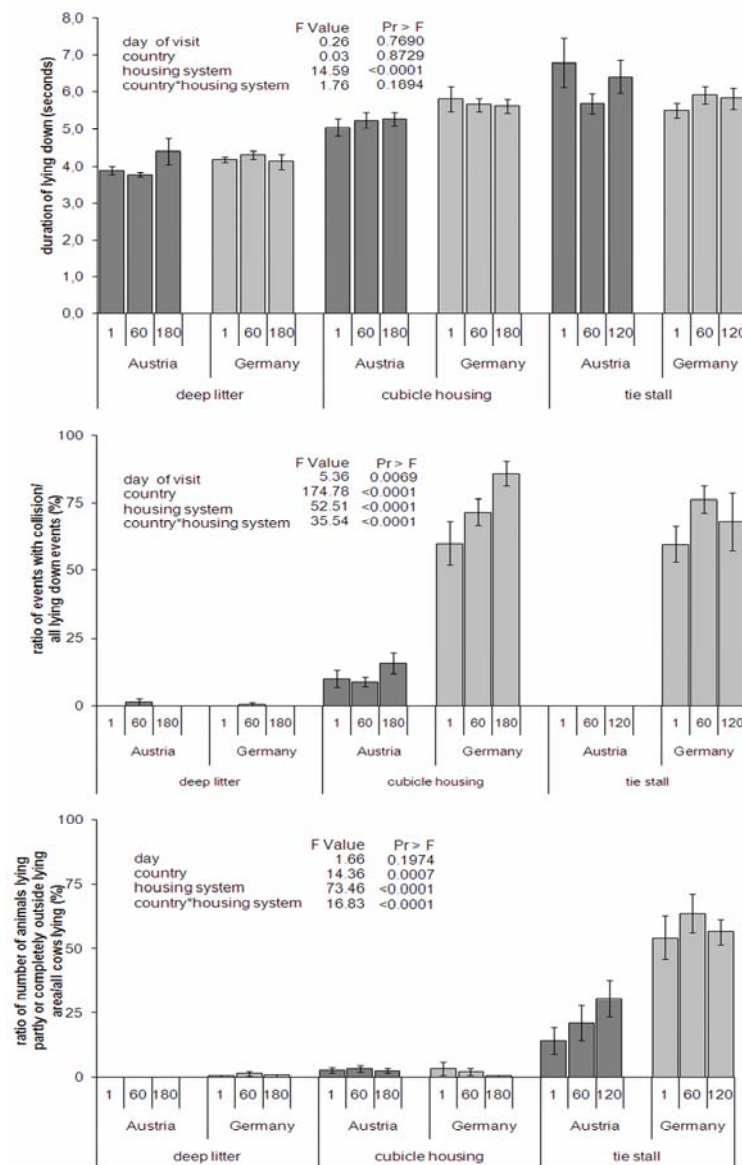

**Figure 1: Durations of 'lying down' and ratios of 'lying down events with at least one collision'/all lying down events and of cows lying 'partly or completely outside lying area'/all cows lying (LSmeans) subject to housing system, country and day of visit and standard error as well as results from analyses of variance**

Covariance parameter estimates for the factor 'farm' in comparison to the residuals were lower for duration of 'lying down' (0.2942 versus 0.7499) and percentage of 'collisions during lying down' (0.0040 versus 0.0123), thus indicating lower between-farm variation than within-farm variation from visit to visit. Only for percentage of cows lying 'partly or completely outside lying area' the day of visit had a minor effect, with covariance parameter estimates for 'farm' being higher than for the residual (61.5349 versus 50.0839).

#### 2.1.4. Discussion

The selection and definition of animal based candidate measures around resting were based on a review of the literature, the authors practical and scientific experience and discussion between the collaborators. They were largely shaped by the requirement of feasibility in the framework of an on-farm welfare assessment protocol.

For instance, it was frequently found with respect to lying down that the duration of the preparatory phase reflects difficulties in lying down very well (Krohn and Munksgaard, 1993; Herlin, 1997; Wechsler et al., 2000; Hörning, 2003b). In some previous studies the search for a lying place (cow walking slowly with muzzle close to the ground) was regarded as a preparatory phase (Krohn and Munksgaard, 1993), and most authors include the stage when the cow showed head swinging movements from side to side with lowered head while standing at the intended lying place as part of the lying down event. Likewise, counts of stepping (Hörning, 2003a) or lying down intention movements such as bending the carpal joint (Wechsler et al., 2000; Veissier et al., 2004) before lying down, or for rising, of crawling (Wechsler et al., 2000) or number of head lunges (Veissier et al., 2004) were reported as potential welfare measures. In our pilot observations it turned out that with the observation method applied it was not possible to reliably measure lying down and rising durations including the preparatory phase due to the lack of a conspicuous, well-defined starting point. The less obvious starting point of rising was also a reason why it was more easily missed than lying down.

When comparing duration of lying down events, the heterogeneous definitions in different studies need to be considered. The average values obtained here, 4.14 up to 6.03 seconds, depending on the housing system, are comparable to a number of investigations in which the same definition was used (Bockisch, 1991; Krohn and Munksgaard, 1993; Wechsler et al., 2000; Hörning, 2003a; Martiskainen et al., 2007). Also with regard to the timing of observations compromises for the sake of applicability in routine assessments had to be found. Because of the social behavioural measures included in the complete assessment protocol it was decided to observe during and after the morning feeding which can be expected to be a time of maximum social activity (Winckler et al., 2002) and later of maximum lying (Overton et al., 2002; Cook et al., 2005). This may have reduced the potentials of measures such as standing on lying area (Cook et al., 2005) or synchrony of lying (Bock, 1990).

Only three out of the 15 investigated measures fulfilled the criteria of the selection process. 'Duration of lying down', percentage of 'collisions during lying down' and percentage of cows 'lying partly or completely outside lying area' occurred frequently

or long enough to allow reliable recording, showed acceptable inter-observer agreement and sufficient correlation between repeated measures over time.

It can be asked whether the criteria were too strict so that promising measures were discarded prematurely. Already seven measures did not fulfil the first precondition of a sufficiently frequent occurrence or proportion of the measure. While the exact limit of 1.0 occurrence per hour observation time or 1 % of animals in the specific position per scan was completely arbitrary, the measures discarded had generally very low average frequencies or proportions, the highest being 0.28 occurrences per hour for abnormal rising (including interrupted and horse-like rising) and 0.44 % of animals lying on side. Moreover, these rare behaviours occur unpredictably and unevenly over time which leads to a high risk of unrepresentative chance observations. For example, abnormal rising, even as binary observation (one-zero), was consistent over all three successive recordings in only 17 out of the 35 farms. Even four hours can only provide a limited snapshot and it needs to be considered that resting behaviour is only a part of all measures recorded during an on-farm assessment. The simulations of reduced observation times clearly showed that the lower the observed frequencies the lower was the repeatability of results over time. The finally selected resting measures could be recorded within two hours with sufficient consistency over time. This underlines the notion of Spoolder et al. (2003) that the feasibility criterion can be particularly restrictive and can act as the main factor for exclusion of animal-based measurements. The extent to which information from rare resting behaviours may be derived from measures that can be recorded more frequently deserves further investigation. For instance, Hörning (2003a) found in six hour observations in 36 cubicle houses substantial correlations between lying down durations and frequencies of horse-like rising or percentage of lying positions with stretched legs. Data loggers or sensors for automatic data acquisition (Wechsler et al., 2000; O'Driscoll et al., 2009) are another future option if they become less expensive and more commonly used on farms.

In the second selection step, relating to inter-observer reliability (IOR), no measures were discarded and results obtained were similar or better compared to other animal based measures such as lameness or responses in behavioural tests (discussed in Knierim and Winckler, 2009). However, for percentage of 'collisions during lying down' it became apparent that the definition needed clarification. IOR was improved after revision of the definition, but this was only done after data recording. Therefore, the significant country effect concerning 'collisions during lying down' (Germany: 0 to 100 % Austria: 0 to 32 %), especially in tie stalls (no collisions during lying down were recorded in Austrian tie stalls, whereas in Germany 29-100 % lying down events with collisions were found), might largely be due to the recording deviations between the two observers. However, also significantly more cows lying 'partly or completely outside lying area' were found in Germany, especially in the tie stalls

which might at the same time reflect that in fact the Austrian farms had in general more appropriate housing conditions.

The last selection step, relating to consistency of results over time, is probably most debatable. Four further measures such as 'synchrony of lying' and 'lying with head resting' did not pass this last selection. Usually for evaluation of repeatability of measures, test-retest or intra-observer reliability are recorded with only a short time lapse in between, or the same situation is assessed repeatedly from videos (Martin, 2007). However, where welfare assessment systems are intended to be used for certification purposes, and may have economic consequences for the farmers, assessment results need to be representative of the longer-term farm situation instead of being sensitive to changes in environmental or internal conditions that are largely insignificant for the welfare state of the animals (Knierim and Winckler, 2009). On the other hand, measures should allow detection of significant changes. In fact, minor alterations were noted on all farms at least once among the three visits. However, we evaluated all of these changes to be within the usual variation in farm conditions that should not affect the principal welfare assessment of the farm.

An alternative way to evaluate consistency of assessments would be to calculate percentages of possible misclassifications (see e.g. de Passille and Rushen, 2005). However, first, this would presuppose a determination of limits for every measure which was outside the scope of our work and secondly, the outcome of the evaluation would largely depend on the level at which limits were fixed. Therefore, we believe that reliability testing by using Kendall correlation analysis was a more appropriate, although not completely satisfactory procedure. On the other hand, even in measures that had been evaluated as sufficiently consistent over time, day of assessment showed a marked influence on results in the analysis of variance with intra-farm variation being higher than between farm variation (for duration of 'lying down' and 'collisions during lying down'). While this sheds some doubt on the long-term repeatability of the assessments, it cannot be ruled out that variation regarding comfort around resting between farms within the same housing system and country truly was rather low. This aspect of repeatability of assessments needs further investigation in the future.

For all three finally selected resting measures significant differences were found between the different housing systems: tie stalls, cubicle systems and loose housing with a littered free lying area (straw yards or sloped floor). In accordance with previous studies (Krohn and Munksgaard 1993; Haley 2000; Hörning 2003b) animal welfare with regard to resting comfort was more impaired in tie stalls and cubicle systems than in straw yards indicated by longer lying down durations, more collisions during lying down and more cows lying partly or completely outside the lying area.

### **2.1.5. Conclusions**

The measures 'duration of lying down', 'collisions during lying down' and 'lying partly or completely outside lying area' are evaluated as suitable animal based welfare measures regarding resting behaviour in the framework of an on-farm welfare assessment protocol. They can be easily recorded within a two hour farm visit, show good IOR and sufficient consistency of results over time. Moreover, they allow differentiation between different housing systems. However their sensitivity with regard to between-farm and within-farm differences over time needs to be further investigated.

## **2.2. Further evaluation of different measures of rising and lying down difficulties for the on-farm welfare assessment in dairy cows**

### **2.2.1. Introduction**

In the analysis described above herd means for 'duration of lying down' and 'collisions during lying down' were used as welfare measures concerning the lying down process. They have the disadvantage that they do not provide information about variances within farms. Thus, it remains unclear how large the proportion of clearly difficult lying down movements are. Winckler et al. (2003) proposed to record the proportion of lying down and rising events that extend a certain duration - according to their proposal of seven seconds - or that are abnormal (e.g. horse-like rising, interrupted attempts). Similar measures were used by Hörning (2003a) who calculated 'difficulty rates' comprising all 'abnormal' resting behaviours. Regarding the limits for 'normal' lying down the Welfare Quality<sup>®</sup> Consortium (2009) proposes values of 5.2 seconds, and of 6.3 seconds marking the limit to a serious problem. In the following a further analysis of the data set described above is undertaken which serves to investigate whether a classification of the lying down data, and also of the data concerning rising, may deliver more information on resting comfort, i.e. to which degree these measures are providing independent or redundant information about rising and lying down difficulties.

### **2.2.2. Materials and Methods**

Animals, material and methods are described in chapter 2.1.2. Additional to the herd means of 'lying down' or 'rising durations', we created six further measures. Two were in accordance with the proposed limits by Winckler et al. (2003): proportion of 'prolonged lying down and rising (>7 sec)'. The limits for the five measures were calculated on the basis of average lying down and respectively rising duration in straw yards (mean value plus one standard deviation for lower and two times for upper threshold), presuming unhindered events under these conditions. Proportion of 'prolonged rising' (>5.6 sec), 'prolonged lying down (>6.2 sec)' and proportion of 'normal duration of lying down (<5.2 sec)' as well as the 'normal duration of rising (<4.6 sec)' were used. The last measure created was the proportion of 'abnormal incidences of rising and lying down'. Abnormal lying down in this case consisted of horse-like rising, lying down with hind quarter first and interrupted events taken together. Potential redundancy of measures was analysed by Spearman rank correlation analysis.

### 2.2.3. Results

While consistency over time for 'herd means' had been acceptable when all observation data were included, with Kendall's W of 0.74 (rising) and 0.78 (lying down, Table 6), this was only true for two further measures: 'prolonged lying down (>6.2 sec)' with W=0.76 and 'normal duration of lying down' with W=0.77. All other measures were below W=0.70 (0.53-0.68). All consistent measures were significantly affected by housing system (tie stalls vs. cubicle vs. deep litter systems; SAS proc mixed), probably reflecting largely unimpaired movements in straw yards and intermediate conditions in cubicle housing, whereas tethered systems can come along with more restrictions.

**Table 6: Consistency over time for behavioural measures using Kendall's coefficient of concordance (W).**

Measure	Kendall's W
Mean rising duration	<b>0.74</b>
Mean lying down	<b>0.78</b>
Normal lying duration down (<5.2 sec)	<b>0.77</b>
Normal rising duration (<4.6 sec)	0.53
Prolonged rising (>5.6 sec)	0.68
Prolonged lying down (>6.2 sec)	<b>0.76</b>
Prolonged rising-lying down (>7 sec)	0.68
Abnormal rising and lyingdown	0.65

Figures in bold exceed threshold of Kendall's W = 0.70

Consistent measures of lying down correlated highly with each other, but only moderately with rising (Table 7).

**Table 7: Calculations of correlations between consistent measures, using Spearman rank correlation coefficient ( $r_s$ ) over all farms (n=35).**

	mean rising duration	mean lying down duration	prolonged lying down	normal lying down
mean rising duration	1	0.452**	0.456**	- 0.404**
mean lying down duration	0.452**	1	0.884**	- 0.850**
prolonged lying down (>6.2 sec)	0.456**	0.884**	1	- 0.829**
normal lying down (<5.2 sec)	- 0.404**	- 0.850**	- 0.829**	1

\*\* Correlation is significant at the 0.01 level (2-tailed).

Correlations of consistent measures to 'abnormal incidences' were negligible to low, with the highest  $r_s=0.302$  to herd means of lying down.

#### **2.2.4. Discussion and conclusion**

Different measures of lying down appear to be exchangeable, with 'herd means of lying down' showing slight advantages with regard to good consistency over time and consideration of all observed events per herd. Measures of rising and 'abnormal incidences' contain independent information to certain, differing degrees, but 'abnormal incidences' show no consistent results over time from five-hours observations as implemented in this study. For rising, consistency over time becomes low when reduced, feasible observation times are applied as described in chapter 2.1. It can, therefore, be concluded that measures concerning rising, lying down and abnormal rising or lying down incidences appear to provide partly independent information on the kind of difficulties dairy cows are experiencing during rising or lying down, depending on the favourability of the environmental conditions. This issue requires further investigation. However, under the aspects of feasibility and representativeness with respect to the longer-term farm situation, currently only measures concerning lying down can be recommended for on-farm resting comfort assessments.



### **3. Epidemiological study on udder cleanliness and resting comfort**

#### **3.1. Effects of housing and management conditions on teat cleanliness of German Holstein-Friesian dairy cows in cubicle systems taking into account body dimensions of the cows**

##### **3.1.1. Introduction**

Dirty udders cause a higher work load for udder cleaning prior to milking (Bernardi et al., 2009) and may constitute a risk for udder health (Schreiner and Ruegg, 2003; Reneau et al., 2005). Therefore, in a number of experimental studies the impact of different housing and management aspects on udder cleanliness has already been investigated. The type of cubicle flooring (Chaplin et al., 2000; Fulwider et al., 2007), absence or presence of a brisket board (Tucker et al., 2006), neck rail position (Tucker et al., 2005; Bernardi et al., 2009; Fregonesi et al., 2009), type of litter (Norrington et al., 2008) (Magnusson et al., 2008) as well as the degree of soiling of the access alley (Christiansson et al., 1999; Magnusson et al., 2008) were found to influence cubicle as well as udder soiling. With regard to cubicle dimensions it was found that restrictive cubicle dimensions result in cleaner stalls (Tucker et al., 2004; Tucker et al., 2005; Tucker et al., 2006) and therefore in cleaner udders (Bernardi et al., 2009; Fregonesi et al., 2009). However, this was not confirmed in epidemiological studies. Neither Veissier et al. (2004) nor Martiskainen et al. (2007) or Lombard *et al.* (2010) discovered any influence of cubicle measures on udder cleanliness. One reason for this discrepancy between experimental and epidemiological studies might be a high interaction effect between the many different cubicle measures and further factors. Additionally, interactions with the cows' body dimensions may be influential. According to literature (CIGR, 1994; Bartussek et al., 2008) suitability of cubicle dimensions should be assessed in relation to the mean body dimensions of the 20-25 % largest cows in the herd. Only Veissier et al. (2004) followed this recommendations and classified cubicles in two categories: smaller or bigger than recommended, i.e. whether they were at least 10 % below or above the optimal value for the 20 % tallest cows in the herd. Only in two of the experimental studies information about body height and length was given (Tucker et al., 2005; Fregonesi et al., 2009), but it remains unclear if and how they had been used to define 'restrictive' cubicles.

Thus, the relationship between characteristics of cubicles, their management and passageway soiling on the one hand and udder or teat cleanliness on the other hand, needs further investigation while body dimensions are taken into account.

Regarding udder or teat cleanliness it is, additionally, questionable whether they should be treated without differentiation, as done in most studies (Cook and Reinemann, 2007; Bernardi et al., 2009; Fregonesi et al., 2009). In some investigations it is not transparent whether teats had been included in the udder scoring (Bowell et al., 2003; Martiskainen et al., 2007; Lombard et al., 2010). Only few studies scored udder and teats separately (Norrington et al., 2008; Magnusson et al., 2008) and sometimes even assessed teat tip cleanliness (Christiansson et al., 1999). Currently, there is a lack of information on associations between udder and teat or teat tip soiling. For instance, Zdanowicz et al. (2004) did not find any clear relationship between udder cleanliness and bacterial counts of environmental pathogens on teat ends, which might be due to a low correlation between soiling of the udder in general and soiling of teats or teat tips.

It was therefore the aim of this epidemiological study on dairy farms in Central Germany to investigate the relationship between udder, teat and teat tip cleanliness and their association with cubicle characteristics and management factors while taking the cows' body dimensions into account.

### **3.1.2. Animals, material and methods**

#### **3.1.2.1. *On-farm data collection***

On-farm data collection took place in the winter housing period 2008 (March until May) and 2009 (February until April) on dairy farms with cubicle housing located in central Germany. Prior to farm selection a catalogue of requirements was assigned. They included a range in herd size from 30 to 120 lactating cows. Farms with more than 120 cows were excluded for feasibility reasons regarding the measurement of the cows, because self-locking feed racks are mostly absent in such bigger herds. The Holstein Friesian herds could either be black and white or red and white. Single cows of other breeds or crossbreeds were tolerated but not included in the study. Cubicles within farms differed in length at maximum 15 cm and in width 10 cm. Partition type, cubicle flooring, litter and neck-rail types had to be identical within each farm. Over 30 farms were visited, but only 23 farms fitted these strict requirements.

Each farm was visited once during the study, starting at morning milking. After the cows had entered the milking parlour and prior to preparation and cleaning of the udders, each teat was scored individually on a scale ranging from 0 (clean) to 3 (very dirty) (Figure 2).

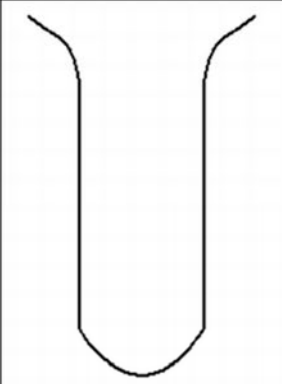
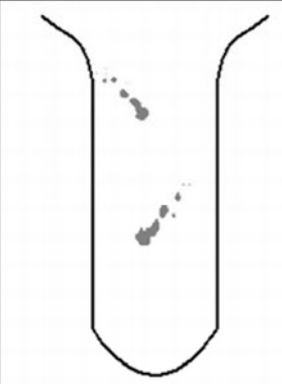
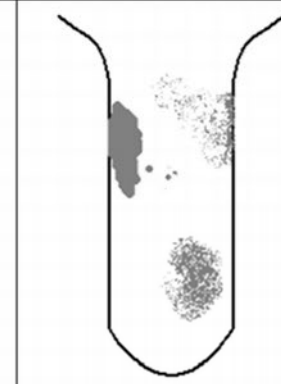
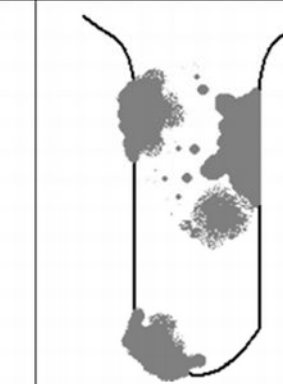
Score			
0	1	2	3
			
Clean (completely)	Slightly dirty (only minor splashing)	Dirty (one small dirty or wet area)	Very dirty (more than one dirty or wet area or caked on dirt)

**Figure 2: Teat cleanliness scoring scheme**

Additionally it was assessed whether each teat tip was completely clean or dirty. After the attachment of the milking machine the cow's abdomen and upper rear limb of the side facing the assessor, as well as the udder (lateral, rear and base) and the tail head (excluding the udder region) were scored regarding their cleanliness according to the scheme of Reneau et al. (2005), but scoring from 0 (clean) to 4 (very dirty) instead of from 1 (clean) to 5 (very dirty). Throughout the study all cows were examined by the same person, wearing a headlight, to avoid an impact of lighting conditions on the assessment. Cows in their colostrum period that were recently moved to the cubicle house (e.g. from a deep litter barn), heifers and other non-lactating cattle present in the main herd were excluded from cleanliness scoring.

A second person recorded the cubicle dimensions (Figure 3), further cubicle and housing characteristics (like cubicle and partition type, cubicle flooring, presence of a brisket board and litter type). For each cubicle condition, e.g. head-to-head or single row cubicles, five to six cubicles were measured per farm.

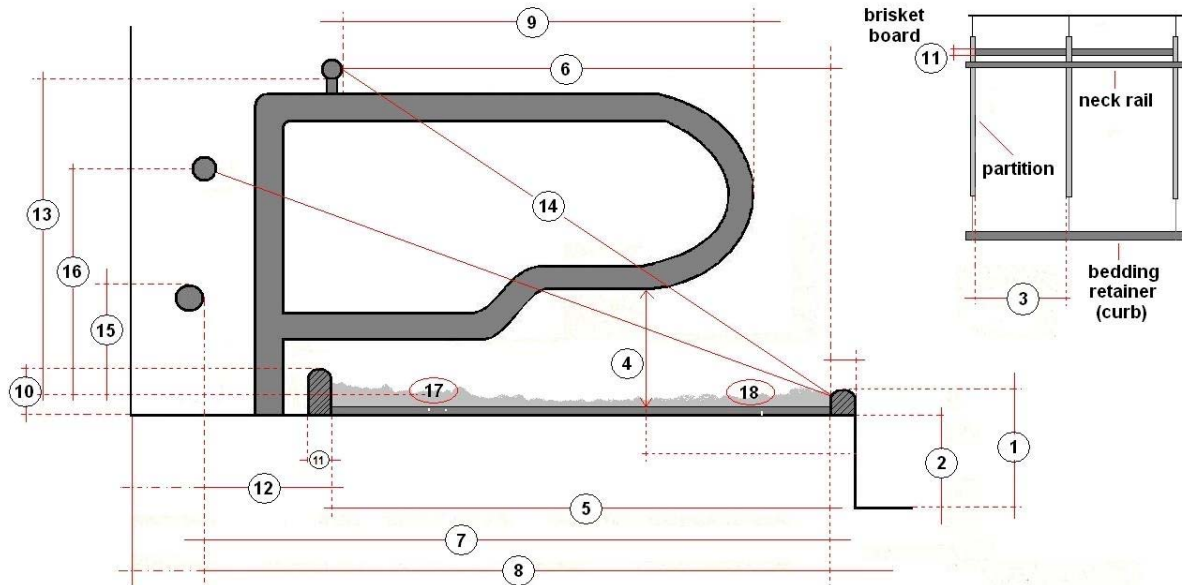

1	Curb height
2	Height of cubicle basis
3	Cubicle width (inner width)
4	Partition height (taken at 75 cm from the rear end of the cubicle)
5	Resting length
6	Neck rail horizontal
7	Front rail horizontal
8	Total cubicle length
9	Partition length
10	Briskeet board height
11	Briskeet board thickness
12	Head lunging space
13	Neck rail height
14	Neck rail diagonal
15	Front rail height
16	Head rail height
17	Location of knee drop test (front)
17	Litter height, front (loose litter)
18	Location of knee drop test (rear)
18	Litter height, rear (loose litter)

**Figure 3: Schematic view of cubicle dimensions that were assessed during the farm visit with description of cubicle measures.**

Cubicle hardness was scored using the knee drop test (categories: soft like well-managed deep bedded cubicle, medium and hard like concrete). Cubicle cleanliness was assessed in three categories with focus on the rear part of the cubicle: clean = dry and no or very few faeces present; medium = some urine and fresh or caked faeces present; dirty = wet/or a lot of dry or caked faeces present.

In each herd, depending on herd size, 100 % (30 cows) to 79 % (115 cows) of cows were randomly selected for measuring body dimensions, but always including the

largest and the smallest cows (visually assessed). After morning milking the cows were locked in the feeding barrier and height at withers, diagonal body length and shoulder width were measured using a water-level controlled measuring stick. Each cow was released immediately after the end of the procedure.

Feeding alley and passageways were scored every five meters (starting with two meters distance from walls) using a 100 x 100 cm (1 m<sup>2</sup>) frame which was divided in nine segments. Each section of the frame was classified as dirty if more than 50 % of the surface was covered with faeces or slurry. Dirty segments were counted and summed up (score from 0 = all clean to 9 = completely dirty). The same was done for scoring of wetness of the passageways.

Furthermore, at the end of the farm visit, details on milking routine, cubicle maintenance and other operations were enquired by a questionnaire guided interview with the farmer. This included estimates of the daily, weekly and monthly time spent for cubicle maintenance which were summed up and converted to the maintenance time per cubicle and day in minutes.

### **3.1.2.2. Calculations on fulfilment of requirements regarding cubicle measures**

Relationships between cow and cubicle dimensions were calculated by applying the recommendations of Bartussek *et al.* (2008). Following their instructions, the mean of the 25 % largest animals of each herd in terms of the height at withers (HW) and the diagonal body length (DBL) were taken. On this basis farm individual target values were calculated for cubicle width, resting length, head space, total length, neck-rail horizontal, as well as for neck-rail height and neck-rail diagonal (by Pythagoras' theorem) (Table 8).

**Table 8: Recommendations for cubicle dimension according to Bartussek *et al.* (2008) considering body dimensions, namely height at withers (HW) and diagonal body length (DBL).**

<b>Cubicle dimensions</b>	<b>Recommendations for cubicle dimensions (cm)</b>
<b>Width</b>	0.86 x HW
<b>Resting length</b>	(0.92 x DBL) + 21
<b>Total length (face-to-face)</b>	(0.92 x DBL) + 21 + (0.32 x HW)
<b>Total length (single row)</b>	(0.92 x DBL) + 21 + (0.56 x HW)
<b>Neck rail height</b>	0.85 x HW
<b>Neck rail horizontal</b>	(0.95 x DBL) + 10
<b>Neck rail diagonal</b>	$(0.92 \times \text{DBL})^2 + (0.75 \times \text{HW})$
<b>Head space (face-to-face)</b>	0.32 x HW
<b>Head space (single row)</b>	0.56 x HW

The degree of compliance with the recommendations was calculated for head-to-head and single row cubicles separately. In order to reach one value per farm, a weighted mean according to the proportion of the two cubicle types was used. If target and current value were equal, compliance was 100 %. Smaller cubicle dimensions yielded values below 100 % and broader cubicles values above 100 %.

### **3.1.2.3. Statistical analysis**

Possible relationships between cleanliness of udders, teats and teat tips were investigated using Spearman's rank correlation analysis.

Linear regression analyses were conducted using the PROC REG procedure with stepwise selection (SAS Version 9.2, SAS Institute) in order to identify risk factors for teat and teat tip dirtiness. The outcome variables were the percentages of teats per herd with score 2 and 3 and of dirty teat tips per herd.

Pre-selection of independent variables for the multivariable regression modelling was carried out by univariable analyses: 'Spearman's rank correlation coefficient  $r_s$ ' for non-normally distributed and 'Pearson's correlation coefficient  $r_p$ ', for continuous, normally distributed measures as well as point biserial correlation coefficient ' $r_{pb}$ ' for dichotomous in combination with metric variables and Fisher-test respectively for dichotomous variables. All predictors yielding values of  $p < 0.3$ , and additionally some potentially important factors according to the literature were presented to the regression modelling procedure. However, predictors that strongly correlated with each other ( $r > 0.70$ ) were not included in the same model to avoid multicollinearity. In those cases the variable with the closer association to the dependent variable was chosen.

The limit for model entry was set at  $p = 0.3$  and at  $p = 0.15$  for variables to stay in the model. Assumptions concerning normality (normal distribution) and homoscedasticity were met. Influence statistics were checked by looking at the studentized residuals and Cook's D. Collinearity within the data was checked using VIF (variance inflation factor) and eigenvalues.

## **3.1.3. Results**

### **3.1.3.1. Descriptive statistics of the study herds**

Average herd size was 59.5 cows (30 to 115 cows). Out of the 1369 cows and heifers present on the farms, in total data of 1171 and 1178 lactating Holstein cows (85.5 %; 86.0 %) were included in cleanliness scoring and measuring of body dimensions, respectively.

Ten farms had deep bedded cubicles and 13 farms raised cubicles including 3 farms with bedding retainers (curbs). Average cow-cubicle-ratio was 1:1 (1:0.8-1.3). Compliance regarding cubicle width, neck rail horizontal, neck rail diagonal and head space was below 100 % on all farms while for the other measures it varied between

76.8 % and 121.7 % (Table 9). Hard cubicle flooring was present on seven (rear part) and eight (front of cubicle) farms, respectively. Post-milking teat dipping was performed on 14 farms. In 13 cases the cubicles were considered to be clean cubicles. The bedding on 15 farms included some type of straw. A brisket board was present on 15 farms.

**Table 9: Compliance of cubicle measures with recommendations for the 25 % tallest cows in the herd (n=23).**

Compliance of cubicle measure	Mean (cm)	Mean (%)	Min (%)	Max (%)
Cubicle width	111.7	88.37	81.70	95.55
Resting length	188.9	103.67	92.25	121.71
Total length	240.8	98.36	83.77	114.59
Neck rail height	111.4	89.24	76.82	106.41
Neck rail diagonal	194.2	89.70	79.64	99.91
Neck rail horizontal	155.0	87.93	77.87	98.06
Head space	51.9	83.05	25.67	99.91

Average height at withers of all measured Holstein Friesian cows (n=1178) was 142.3 cm with a standard deviation of 4.1 cm (Figure 4).

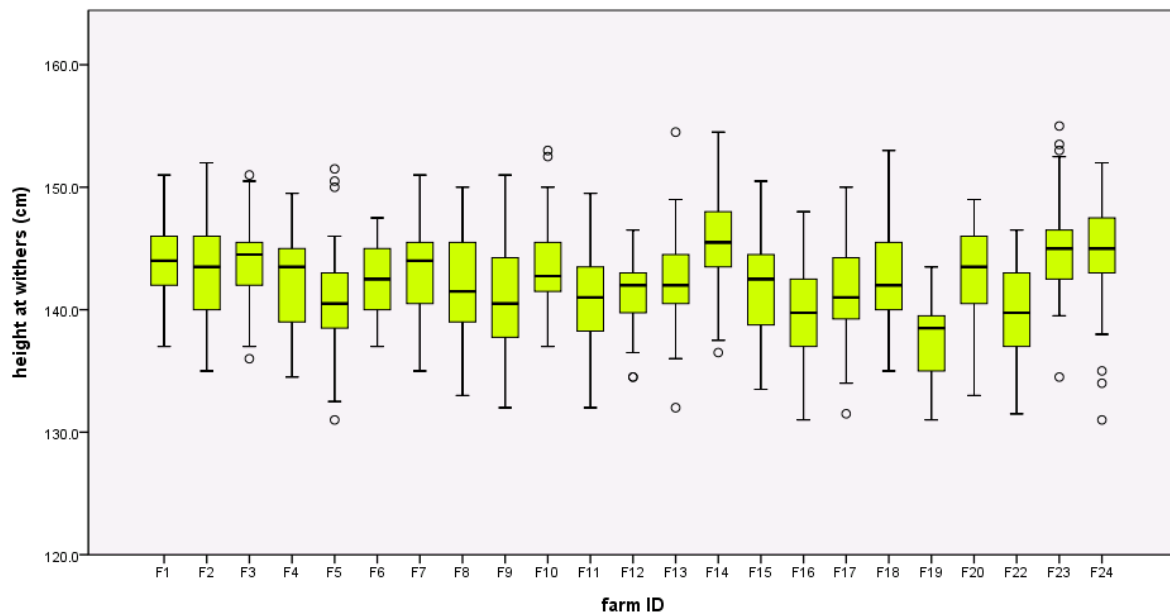

**Figure 4: Box plots of height at withers for all study farms with whiskers with maximum 1.5 IQR and outliers (points)**

A higher variation was observed in diagonal body length with a mean of  $166.2 \pm 7.5$  cm (Figure 5). Shoulder width was on average  $47.6 \pm 4.3$  cm (not used for further calculations).

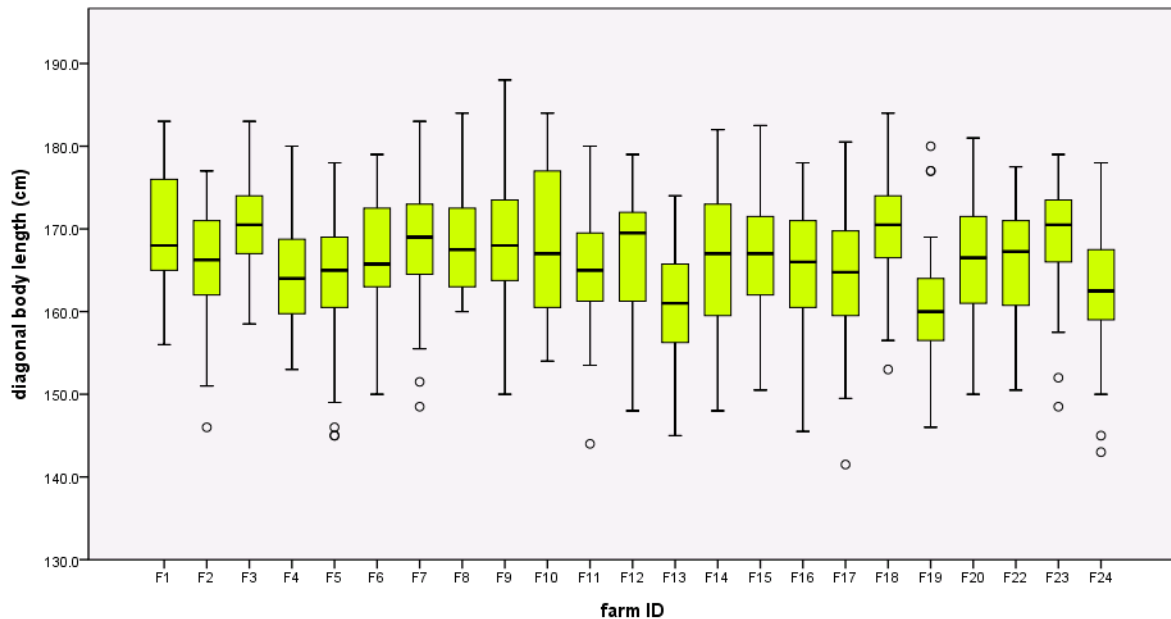

**Figure 5: Box plots of diagonal body length for all study farms with whiskers with maximum 1.5 IQR and outliers (points)**

The average height at withers of the 25 % largest animals in the herds was  $146.9 \pm 3.8$  cm and  $174.7 \pm 4.1$  cm for diagonal body length.

On average 18.8% of the cows' tail heads, 29.9% of the hindquarters, 16.5% of the bellies and 11.1% of the udders were scored dirty or very dirty (score 3 and 4). Including score 2 (moderately dirty) mean percentage of dirty udders was 52.2%. Mean udder hygiene score was  $1.53 \pm 0.35$  (scale from 0 to 4). The percentage of dirty udders (scored 3 or 4) on average yielded  $11.3 \pm 9.4$  %. On a scale from 0 to 3 the average teat cleanliness score was a  $1.45 \pm 0.23$ . The amount of dirty and very dirty teats (score 2 and 3) was  $56.0 \pm 10.3$  % and of dirty teat tips  $41.2 \pm 11.4$  %.

### **3.1.3.2. Correlations between cleanliness measures**

On the individual level ( $n=1171$  cows) measures of udder, teat and teat tip cleanliness were significantly correlated with each other (Table 10). On herd level ( $n=23$ ), there was no significant correlation between the percentage of udders scored 2, 3 or 4 and the percentage of dirty teats (score 2 and 3;  $r_s= 0.231$ ,  $p= 0.288$ ) or the percentage of dirty teat tips ( $r_s= 0.117$ ,  $p= 0.595$ ). Furthermore, the percentage of dirty teat tips was not significantly correlated with the percentage of dirty teats ( $r_s= 0.223$ ,  $p= 0.306$ ).



**Table 10: Correlations between different hygiene scores with regard to specific udder areas on cow level (n=1171). Spearman's rank correlation coefficient ( $r_s$ ) for udder score, mean teat score, proportion of dirty teats (teats scored 2 or 3 per all assessed teats) and the proportion of dirty teat tips (dirty teat tips per all scored teats).**

	Udder score	Mean teat score	Proportion of dirty teats
<b>Udder score</b>	1		
	.		
<b>Mean teat score</b>	0.410***	1	
	0.000	.	
<b>Proportion of dirty teats</b>	0.370***	0.936***	1
	0.000	0.000	.
<b>Proportion of dirty teat tips</b>	0.303***	0.703***	0.625***
	0.000	0.000	0.000

### **3.1.3.3. Multivariable analyses of impacts on teat cleanliness**

Six dichotomous and eleven metric variables, representing certain farm characteristics, were used for stepwise regression regarding possible effects on the percentage of dirty teats. Correlations of dirty teats and respectively teat tips with potential predictors are presented in Table 11. Variables with figures in bold were included in the multivariable analyses..

**Table 11: Correlation between cleanliness measures and cubicle characteristics using Pearson Correlation Coefficient ( $r_p$ ) and point biserial correlation coefficient ( $r_{pb}$ ).**

Variable	Class and unit	Model			
		Teat soiling		Teat tip soiling	
		r	p	r	p
Compliance of cubicle width	%	-0.080	0.716	<b>-0.353</b>	<b>0.099</b>
Compliance of total cubicle length	%	<b>0.276</b>	<b>0.203</b>	-0.062	0.777
Compliance of resting length	%	-0.022	0.919	<b>0.276</b>	<b>0.202</b>
Compliance of neck rail height	%	<b>0.417</b>	<b>0.048</b>	-0.071	0.747
Compliance of neck rail horizontal	%	-0.040	0.858	<b>0.238</b>	<b>0.275</b>
Partition length (from neck rail)	cm	<b>-0.379</b>	<b>0.075</b>	-0.148	0.501
Bedding material included straw	No, yes	<b>-0.313</b>	<b>0.146</b>	0.145	0.510
Curb height (from alley)	cm	0.022	0.919	<b>0.237</b>	<b>0.276</b>
Height of litter curb (inside cubicle)	cm	<b>-0.366</b>	<b>0.086</b>	<b>-0.238</b>	<b>0.274</b>
Space between bedding retainer or rear end of cubicle and cubicle partition	cm	<b>0.255</b>	<b>0.241</b>	<b>0.356</b>	<b>0.095</b>
Presence of bedding retainer	No, yes	<b>-0.369</b>	<b>0.084</b>	-0.145	0.510
Cubicle type	Deep bedding vs. others	<b>-0.295</b>	<b>0.171</b>	<b>-0.450</b>	<b>0.031</b>
Cubicle base (flooring)	Deep bedding or comfort mattress vs. mat or concrete	-0.040	0.857	<b>-0.365</b>	<b>0.087</b>
Soft flooring at rear part of cubicle	No, yes	<b>-0.238</b>	<b>0.239</b>	<b>-0.468</b>	<b>0.024</b>
Clean cubicle	No, yes	<b>0.159</b>	<b>0.469</b>	<b>0.150</b>	<b>0.496</b>
Litter height (rear part of cubicle)	cm	-0.256	0.239	<b>-0.468</b>	<b>0.024</b>
Daily maintenance time per cubicle	Minutes	<b>-0.275</b>	<b>0.204</b>	-0.085	0.698
Post milking teat disinfection	No, yes	<b>-0.480</b>	<b>0.020</b>	0.039	0.861
Dirty/wet areas on alley	%	0.155	0.480	<b>-0.408</b>	<b>0.053</b>
Solid floor (alley)	%	-0.057	0.797	<b>-0.399</b>	<b>0.059</b>
Standard deviation of height at withers	cm	<b>0.267</b>	<b>0.217</b>	0.175	0.423
Standard deviation of diagonal body length	cm	<b>0.224</b>	<b>0.304</b>	-0.085	0.700

The final model for soiled teats contained four factors and explained 58.5 % of the total variance ( $F=6.34$ ,  $p=0.0023$ , Table 12). Significantly fewer dirty teats were predicted if compliance with recommendations for total cubicle length was lower, when teat dipping was conducted after milking and when a higher amount of time was spent for cubicle maintenance. The factor cubicle type also contributed to the model, although not significantly ( $p>0.05$ ), with fewer dirty teats if deep bedded cubicles were present. No influencing cases or problems with collinearity were found.

**Table 12: Final model of stepwise regression (PROC REG stepwise, SAS 9.2) with the dependent variable 'percentage of dirty and very dirty teats' including 17 independent variables (n=23).**

Predictor variables	t -value	p - value	Parameter estimate	Partial R <sup>2</sup>
<b>Teat dipping</b>	-3.21	0.0048	-10.575	0.2268
<b>Cubicle maintenance time (min/day)</b>	-2.58	0.0187	-21.704	0.1632
<b>Compliance of total cubicle length (%)</b>	0.0317	2.33	0.568	0.1251
<b>Cubicle type</b>	0.0265	-2.42	-8.106	0.0696

Regarding the percentage of soiled teat tips the final model explained 46.0 % of the variance and included three variables ( $F=5.39$ ,  $p=0.0075$ , Table 13). A significantly lower percentage of dirty teat tips was found with increasing litter height at the rear part of the cubicle and with lower fulfilment of recommendations regarding resting lengths of cubicles. Also the factor dirtiness of the alleys contributed to the model, though not significantly ( $p>0.05$ ). Contrary to expectations, higher alley dirtiness tended to be associated with a lower percentage of dirty teats. No problem with collinearity was detected, but one influential case was found (student residual= 2.969, Cook's D= 0.461).

**Table 13: Final model of stepwise regression (PROC REG stepwise, SAS 9.2) with the dependent variable 'percentage of dirty teat tips' including 14 independent variables (n=23).**

Predictor variables	t -value	p - value	Parameter estimate	Partial R <sup>2</sup>
<b>Litter height, rear part of cubicle (cm)</b>	-2.89	0.0094	-2.756	0.2094
<b>Compliance of resting length (%)</b>	2.12	0.0470	0.457	0.1522
<b>Alley soiling (%)</b>	-1.86	0.0790	-0.176	0.0980

### 3.1.4. Discussion

Cow cleanliness was assessed in a number of epidemiological studies, but all of them only analysed the impact of housing and management related factors on overall cow cleanliness or soiling of specific body parts (e.g. Veissier et al., 2004; Martiskainen et al., 2007; Ruud et al., 2010). In line with results from Schreiner and Ruegg (2003), who reported 14.2 % udders mostly covered with dirt and 7.4 % completely dirty udders, a high percentage of cows in the present study had soiled udders, whereas Ruud et al (2010) found much lower values (4.7 % dirty and very dirty udders) from relatively small farms (38,6 cows/herd), which was attributed to improved individual cleaning and general care due to small herd sizes. Reneau et al. (2005), on the other hand, found even dirtier udders and larger variation in terms of the mean udder score. Compared to other parts of the body, a lower percentage of udders was found to be dirty, which was also found in other studies (Schreiner and Ruegg, 2003; Veissier et al., 2004; Ruud et al., 2010).

On individual cow level, correlations between udder cleanliness score and percentage of dirty teats and teat tips were only low ( $r_s=0.370$  and  $0.303$ ), but significant due to the high N. On herd level correlations between percentages of dirty udders (score 3 and 4) and teats or teat tips were even lower and not significant. According to these results it appears necessary to differentiate between udder, teat and teat tip cleanliness or soiling. Also results from Christiansson et al. (1999) indirectly suggest that cleanliness between different udder regions varies. They found that udder, teat and teat tip soiling were significantly associated with spore concentration of foremilk, but dirty teats were the only measure significantly correlated with average daily spore content of milk. Those areas should be selected for hygiene scoring that are adequate for the specific problem investigated. In terms of work load for udder cleaning prior to milking, in particular teats and teat tips are of concern. In addition, soiled teat tips may constitute a special risk for invasion of environmental pathogens through the streak canal and thus for mastitis. Therefore, we focused our analysis on teat and teat tip cleanliness expressed as percentages of dirty teats or teat tips.

The farms investigated in this study were typical Central German farms regarding breed (predominantly Holstein Friesian), size and husbandry conditions although no attempt had been made to select a representative sample of this region. Instead, the main focus of farm selection was on Holstein breed and uniformity of cubicles within farms to allow a stringent analysis of possible associations between cubicle characteristics, cow dimensions and cleanliness. It was unexpectedly difficult to find farms with sufficiently uniform cubicles, leading to a relatively small dataset. However, the assessment of about 86 % of cows provided relatively exact data for each herd.

Cubicle dimensions on the investigated farms did largely not comply with common recommendations such as those from Bartussek et al. (2008). This applied, for instance, for 52 % of the farms regarding the total resting length. This finding is in line with statements e.g. from Phillips (2002) that common cubicles are too small due to the increasing sizes of the modern dairy cow. Also Veissier et al. (2004) reported from their investigation on 70 farms in France that only few cubicles corresponded ( $\pm 10$  %) with the recommendations of CIGR (1994), which are largely comparable to Bartussek et al. (2008). Neck rail height for example complied in 20 %, total length in 26 % and resting length in 23 % of the farms (Veissier et al., 2004). If we apply the criteria of Veissier et al. (2004), considering 90-110 % compliance as adequate, comparable 30 % of farms provided sufficient neck rail height, anyhow, 78 % adequate total length and 73 % sufficient resting length, but only 39 % an adequate neck rail horizontal, 26 % sufficient cubicle width and only 9 % of farms sufficient head space. Thus, compared to the results of Veissier et al. (2004), compliance concerning neck rail positioning was similarly low, but concerning total length as well as resting length considerably higher, even though up to a third of farms did not comply with the recommendations.

Contrary to expectations, larger variation in body sizes was not associated with higher teat or teat tip soiling. However, it should be borne in mind that cubicle dimensioning was rather restrictive in this study (as measured by the 25 % largest cows per herd), which might account for the absence of a distinct relationship between soiling and body size variation. The generally restrictive cubicle dimensions in relation to body dimensions have to be borne in mind when interpreting the results of our regression analyses.

Nevertheless, the final regression model concerning dirty teats contained total cubicle length as a predictive variable, with about 0.6 % predicted increase in dirty teats with each percentage of increase in compliance. This generally conforms to the findings from experimental studies (Tucker et al., 2004; Bernardi et al., 2009; Fregonesi et al., 2009) that cubicles considered to be restrictive, lead to better cleanliness, but is in contrast to the findings of Martiskainen et al (2007); and Howell et al. (2003) in their epidemiological studies. As both have not taken into account body dimensions of the cows, this may serve as one tentative explanation for the discrepancy to the present results. Another aspect is the assumption of Howell et al. (2003) that, depending on the level of restrictiveness, insufficiently dimensioned cubicles in fact may contribute to increased dirtiness if hind quarters or tails are hanging over the edge of the cubicles and drop onto the passageway, thereby getting soiled. In fact, cubicles in our study were on average about 45 cm longer than reported by Howell et al. (2003), and it is worth mentioning, that also in the present study three out of four farms, that yielded less than 90 % compliance, showed teat soiling rates above the overall farm average. This points at a possible non-linear

relationship, for which linear statistical analysis might not be an adequate approach. This should be observed in future studies.

Even though within the range of cubicle lengths investigated in this study, shorter cubicles turned out to be beneficial for teat cleanliness, three further factors contributed to the final regression model and partly explained more of the variation between farms. This was true for cubicle maintenance time and whether teat dipping was performed or not.

Each extra minute spent for cubicle maintenance according to the model hypothetically decreases the percentage of dirty teats by about 21.7 %. This is in agreement with results from other studies that the frequency of bedding replacement and service, such as removal of faeces, positively influences cow cleanliness (Veissier et al., 2004; Fulwider et al., 2007; Martiskainen et al., 2007). Unfortunately, for economic reasons such as cost of labour and bedding materials farmers often do not fully implement this well-known measure (Weary et al., 2008).

Teat dipping was predicted to result in about 10.6% less dirty teats. It is unlikely that teat dipping has a direct effect on teat soiling as teat scoring had been carried out before cleaning and milking. Instead, this effect may be attributable to the general management style of the farms. Barkema et al. (1999) found that post-milking teat dipping was performed on farms with a 'clean and accurate' management style for several years longer than on farms with a 'quick and dirty' style. Thus, teat dipping may be an indicator for an overall precise working attitude.

The last predictive variable in the model was cubicle type, accounting for about 8.1 % less dirty teats on farms with deep bedded cubicles. Interestingly, the estimated average time spent for daily cubicle service and cleaning was almost the same for farms with deep bedded cubicles (0.37 minutes/cubicle/day) and raised cubicles (0.43 minutes/cubicle/day). As mentioned before, hardly any information is available on teat hygiene in dependence from housing factors. Norring et al. (2008) found dirtier udders in straw stalls compared to sand bedding. However, no sand stalls were present in our study, so no comparison was possible in this regard.

Concerning dirty teat tips, a clear benefit of increased litter height in the rear part of the cubicle became apparent. With each additional cm of litter height a decrease of about 2.8 % soiled teat tips was predicted. This is in line with the finding of Magnusson et al. (2008) that an increasing amount of bedding improves cleanliness of teat and teat tips.

Resting length was the second influential variable, though explaining less variation between farms than litter height. Per each percentage of increase in compliance about 0.5 % increase in soiled teat tips were predicted.

The last, though not significant predictive variable was the percentage of soiled passageways. The predicted decrease in soiled teat tips of about 0.2 % with

increased soiling of the alleys is difficult to explain and in opposition to results from Christiansson et al. (1999) and Magnusson et al. (2008).

Both final models contained a measure of cubicle length. The difference between total cubicle length and resting length lies in the head lunging space. As compliance concerning total cubicle length and head lunging space were significantly correlated, it was decided to present total cubicle length to the models due to the higher correlation with the outcome variable. In general, effects of cubicle length cannot be considered independently from the neck rail position. In contrast to other studies (Tucker et al., 2005; Bernardi et al., 2009; Fregonesi et al., 2009), the neck rail position did not appear as predictive factor, even though in the univariable pre-selection of factors the neck rail height was significantly correlated with the percentage of dirty teats ( $r_p=0.417$ ,  $p=0.048$ ). However, the height of the neck rail complied with recommendations on only three farms, horizontal and diagonal position on no farm at all. Perhaps results would have differed with sufficient neck rail positions. As described by Tucker et al. (2005) and Bernardi et al. (2009), restrictive neck rail placement possibly prevents cows from standing in the cubicle, but still allows the cows to lie in a fore position in the cubicle, while limiting the cow's movements during lying down or rising (Veissier et al., 2004). Even though total length was sufficient on about half of the farms, the cows perhaps avoided to rise due to restrictive neck rail placement and defecated whilst lying in the cubicle, as reported by Whistance et al. (2007) or Fregonesi et al. (2009). In combination with a longer cubicle where the cow's rear is lying further from the curb, the faeces may be deposited where perhaps another cow's udder is placed afterwards.

In the course of this it is a general question whether the recommendation to adapt cubicle dimensions to the 20 to 25 % largest cows in the herd is appropriate. This will to a certain degree relate to the individual replacement rates within the dairy herds. At the high replacement rates that are presently common, it can hardly be avoided that at least one quarter of the herd consists of heifers and therefore mostly small cows. This considerably increases the number of cows that experience relatively more generous cubicle dimensions. However, at least under the relatively restrictive cubicle conditions investigated here, no evidence for effects of larger body size variations on cleanliness could be found.

### **3.1.5. Conclusion**

Even under relatively restrictive cubicle conditions, a certain increase in teat and teat tip soiling can be expected with increasing cubicle length. However, at the same time, there are further feasible and effective measures available to limit teat and teat tip soiling. They are related to good management and specifically litter management in the cubicles. Also deep bedded cubicles yield advantages in this regard. Both regression models for teat and teat tip cleanliness contained similar, but not identical

predictive variables. This indicates that dirtiness of each particular area may originate from slightly different though related causes. The low correlations between udder, teat and teat tip cleanliness should be considered in future studies.



## **3.2. Effects of cubicle characteristics in relation to cow body size on lying down behaviour in German Holstein dairy cows**

### **3.2.1. Introduction**

The freedom to express normal behaviour without the experience of discomfort, pain or injuries is an important component of good animal welfare (FAWC, 2001; Welfare Quality<sup>®</sup> Consortium, 2009) of which resting behaviour is a significant subcomponent (Welfare Quality<sup>®</sup> Consortium, 2009). Again, one aspect of resting behaviour is the lying down which is normally displayed as one quick and fluent movement, if it is not constrained by environmental factors (Krohn and Munksgaard, 1993). Constraints can arise through insufficient cubicle dimensions in terms of e.g. width (Keil et al., 2003; Tucker et al., 2004), length (Hörning, 2003a), neck rail position (Martiskainen et al., 2007; Bernardi et al., 2009) or through inadequate partitions (O'Connell et al., 1992), cubicle bases (Herlin, 1997; Tucker et al., 2003; Wagner-Storch et al., 2003; Norring et al., 2008), bedding quality (Hörning, 2003a; Drissler et al., 2005; Fregonesi et al., 2007b; Reich et al., 2010) or brisket boards (Tucker et al., 2006). Impaired lying down behaviour may result in a decreased resting quality in general and can increase the risk for health problems such as lesions (Wechsler et al., 2000; Norring et al., 2008) or lameness (Faull et al., 1996; Bowell et al., 2003; Bernardi et al., 2009).

However, at the same time generous cubicle dimensions were found to have a negative impact on cow and cubicle cleanliness (Tucker et al., 2004). In order to avoid soiling, in practice often rather restrictive cubicle dimensions are therefore recommended or implemented. The conflicting mechanisms apparently pose a dilemma from an animal welfare point of view between recommendations with regard to cleanliness on the one hand and good resting comfort on the other.

One further complication of investigations on lying down behaviour is the need to relate cubicles dimensions to the cows' body sizes (CIGR, 1994). However, all but one experimental and epidemiological studies carried out until now used absolute reference figures and often applied the term 'restrictive cubicle dimensions' without clearly defining it. The results of these investigations, therefore, may need to be treated with caution.

For the welfare assessment concerning lying down we identified the mean duration of lying down as well as the proportion of lying down events in which collisions with the equipment occurred as feasible and reliable measures for the use in on-farm studies (see chapter 2). It was the aim of this exploratory study to determine which cubicle characteristics may affect these measures when taking cow body dimensions into

account. In addition, descriptive information shall be given about further measures of resting comfort on the study farms relating to further disturbances of lying down behaviour and resting positions.

### **3.2.2. Animals, material and methods**

#### **3.2.2.1. On-farm data collection**

On-farm data collection is described in chapter 3.1.2.1. However, the following analyses include 24 instead of 23 farms. The duration of lying down (in seconds) and collisions during lying down were recorded according to the description in chapter 2.1.2.1.

Three persons were involved in the observation of lying down behaviour. Prior to the farms visits they underwent a training using video clips and they achieved very high intra and inter-observer reliability ( $r=0.904^{**}$ -  $0.956^{**}$ ).

Behavioural observation on herd level started half an hour after body dimensions of the cows were measured (see chapter 3.1.2.1.). If possible 30 successful lying down events per farm were observed. However, on two farms only 29 instead of 30 successful lying down events had been recorded. Collisions with cubicle partitions, i.e. forceful hits that were obviously seen or heard, were counted on a one-zero basis per lying down event. The definition of interrupted lying down events (Table 1) was extended to lying down events that lasted more than 20 seconds which were not observed completely. However, these events were only included in the descriptive statistics.

Additionally, for descriptive purposes, instantaneous scan sampling was performed in 30 minute intervals for at least three times. The numbers of animals feeding (including drinking), standing, standing in cubicles and lying as well as the specific lying positions were recorded. Distinction was made between 'hind quarter on edge', 'hind quarter outside lying area', 'lying completely outside lying area', 'dog-sitting' and 'lying backward'.

#### **3.2.2.2. Calculations prior to analyses**

Relationships between cow and cubicle dimensions were calculated as described in chapter 3.1.2.2.

#### **3.2.2.3. Statistical analysis**

Stepwise regression (SAS, proc reg stepwise) for 'mean duration of lying down' included 19 independent variables (10 metric and 9 dichotomous). The following predictors were used: cubicle type, the presence/absence of a bedding retainer, the absence/presence of a brisket board, cubicle surface (deep bedded or comfort mattress vs. rubber mat or concrete), presence/absence of bedding material, partition type (cantilever or not), curb height, compliance of cubicle width, partition height,

partition length, compliance of resting length, compliance of neck rail height, compliance of neck rail diagonal, restriction of head lunging space (no obstacle within 300 cm from rear end of cubicle), cubicle hardness front, cubicle hardness rear, litter height front and litter height in the rear part of the cubicle. Due to the exploratory character of this analysis, the limit for model entry was set at  $F_{in}=0.5$ , and  $F_{out}=0.2$  for removal.

### 3.2.3. Results

Lying down took on average 5.8 seconds (Figure 6). During on average  $45.8 \pm 18.2$  % of all lying down events at least one collision occurred, whereas  $5.4 \pm 5.6$  % lying down attempts were interrupted (Figure 7). The percentage of cows lying partly or completely outside lying area was on average  $38.8 \pm 15.8$  %. 'Dog-sitting' only occurred once on one farm and 'lying backward' was recorded twice on another farm.

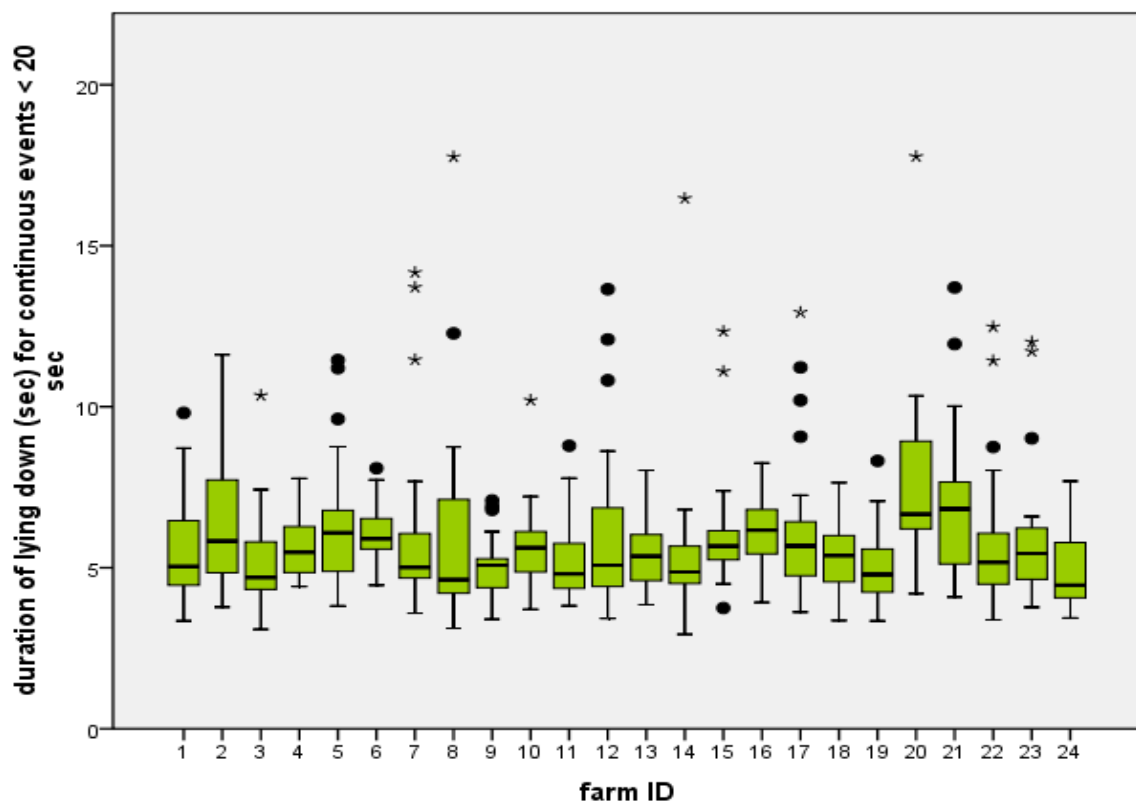

**Figure 6:** Box plot for durations of lying down per farm (n=24) with whiskers with maximum 1.5 IQR and outliers (points) and extreme outliers (asterisks)

On some of the farms that yielded low lying down durations, collisions and interruptions occurred to a high extent (Figure 7).

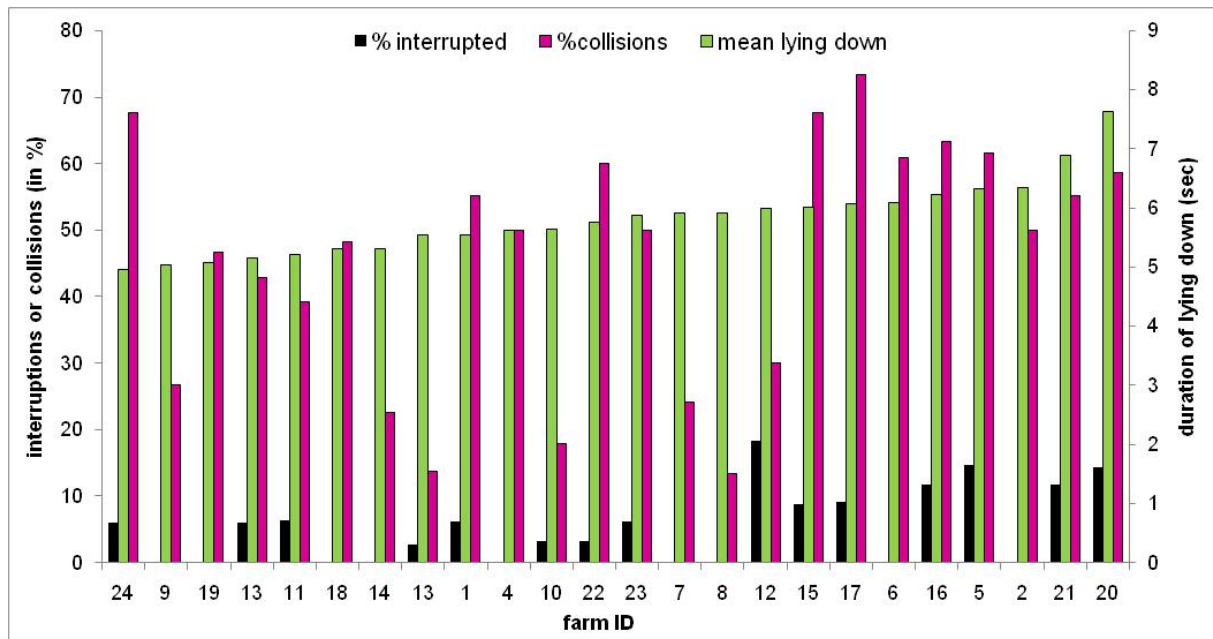

**Figure 7: Mean duration of lying down, percentage of events with at least one collision during lying down and percentage of interrupted events per farm (n=24)**

The average height at withers over the 24 farms was 142.1 cm (range: 26 cm) and the diagonal body length was 165.7 cm (range: 46.5 cm). The final model explained 54.8 % of the total variance ( $F=5.76$ ,  $p=0.0033$ ). Lying down duration was significantly shorter in deep bedded cubicles ( $F=11.48$ ,  $p=0.0026$ ). This variable predicted for a reduction of -1.1 seconds whilst explaining 34.3 % of the total variance. Further non-significant explanatory factors in the model were the compliance of neck-rail height ( $F=2.75$ ,  $p=0.1121$ ), deep bedding or comfort mattresses versus concrete floor or rubber mats ( $F=2.07$ ,  $p=0.1658$ ) and clearance height of side partitions ( $F=3.13$ ,  $p=0.0930$ ). Increasing partition height and neck rail height compliance predicted for shorter lying down durations, whereas concrete and rubber mats predicted for longer lying down durations. On average recommendations on neck rail height were fulfilled in 89 % of farms (range 77-106 %) and average partition height (measured in 75 cm distance from rear curb) was 54 cm (range 44-94 cm).

No valid model resulted from the analysis concerning 'percentage of collisions during lying down'.

### 3.2.4. Discussion

Shorter lying down durations were predicted in deep bedded cubicles. This is in line with results of Hörning (2003a), who found a significant influence of the amount of straw bedding on lying down duration. One possible reason for this may be the softness or elasticity of the lying area, the other the non-abrasive quality of straw.

The latter effect is also supported by findings that the presence of straw reduces lesions and swellings at the legs (Wechsler et al., 2000; Potterton et al., 2011). The development of such lesions is likely associated with aversive experiences during lying down. The fact that the presence of 'deep bedding or comfort mattresses' compared to 'concrete floor or rubber mat' was a further contributing, though not significant factor supports that both mechanisms (abrasiveness and softness) probably play a role. In accordance with the findings of Martiskainen et al. (2007), an increasing compliance of neck rail height, even though not significantly, predicted for shorter lying down durations, but in contrast to their results, neck rail horizontal did not predict for duration of lying down, although neck rail positions were comparable between studies. On all farms of the present study neck rail horizontal was insufficient for the 25 % largest animals according to the recommendations of Bartussek et al. (2008). Probably, the low positioning of the neck rail (on 22 out of 23 farms the neck rail height was too low even for the 25 % smallest cows in herd) might have rather impaired rising instead of lying down.

The results on cubicle surface correspond with previous studies (Krohn and Munksgaard, 1993; Herlin, 1997). The effect of partition height, which was non-significant, might probably be related to the partition type, which has been reported to be significantly correlated with duration of lying down (Hörning, 2003a). The descriptive results show that only three farms had average durations of lying down above 6.3 seconds, which was classified by the Welfare Quality<sup>®</sup> consortium (2009) as an indication of serious problems. However, there were also a number of farms with mean durations below 6.3 seconds on which a high proportion of lying down events with collisions or interrupted lying down events occurred. In total on 18 farms more than 30 % collisions occurred per all observed events, which marks the limit indicating serious problems according to the Welfare Quality<sup>®</sup> consortium (2009). Also the average proportions of cows lying partly or completely outside the lying area reflect problems during recumbency on many farms. The Welfare Quality<sup>®</sup> consortium (2009) proposes 5 % of such lying positions as a threshold marking a serious problem. All farms exceeded this threshold to a high extent. However, preliminary analyses revealed that also concerning this factor no valid regression model could be achieved.

One of the 24 farms showed rather conspicuous results in that cows still suffered from problems resulting from being tethered until one year prior to farm visit, even though cubicles were generous and comfortable. It was, therefore, decided to remove data from this farm from all other analyses.

### **3.2.5. Conclusions**

Under the conditions investigated, cubicle type was highlighted as the most important factor affecting lying down duration as a measure of resting comfort. However, a considerable proportion of variance remains unexplained. Moreover, other measures of resting comfort such as collisions during lying down appear to bear further important information, but did not allow a meaningful analysis with the current data set and statistical approach.

### **3.3. Relationship between lying down behaviour, cubicle characteristics and udder hygiene**

#### **3.3.1. Introduction**

Apart from cubicle properties, management practices can influence both behaviour and cleanliness. The farmer's management style, which is associated with its attitude, can influence cow cleanliness (Barkema et al., 1999), whereas specific practices e.g. cubicle maintenance (Veissier et al., 2004; Fulwider et al., 2007; Martiskainen et al., 2007) or stocking density (Fregonesi et al., 2007a) can influence behaviour as well.

The present epidemiological study aimed to investigate the impact of cubicle characteristics and management factors on lying down behaviour and udder cleanliness while considering body dimensions of the cows. With regard to udder cleanliness a particular focus was set on teats and teat tips because decreasing hygiene of teats may come along with higher work load for cleaning prior to milking and soiling of teat tips probably facilitates the invasion of environmental pathogens via the streak canal.

#### **3.3.2. Animals, materials and methods**

##### **3.3.2.1. On-farm data collection**

On-farm data collection is described in chapter 3.1.2.1. and 3.2.2.1. For this analysis only 23 farms were considered. With regard to lying down behaviour the duration, number of interrupted lying down movements and of events that included collisions with cubicle partitions were used for the present analysis.

##### **3.3.2.2. Calculations prior to analyses**

Relationships between cow and cubicle dimensions were calculated as described in chapter 3.1.2.2.

A measure 'impaired lying down' was calculated that included the number of lying down events that were either interrupted or took longer than 6.3 seconds as well as lying down events below 6.3 seconds during which at least one collision occurred per all observed lying down occurrences (including interrupted or prolonged events) per farm.

##### **3.3.2.3. Statistics**

'Spearman's rank correlation coefficient  $r_s$ ' for ordinal, non-normal distributed and 'Pearson's correlation coefficient  $r_p$ ' for continuous and dichotomous, normal distributed measures were used to select independent measures prior to regression

analyses. For inclusion only measures yielding  $p < 0.3$  were chosen. In total 13 independent predictors out of 21 were selected in relation to the outcome variable 'impaired lying down' (Table 14). No factor relating to management aspects except cow/cubicle ratio passed the pre-selection. Regression analyses were conducted in SAS Version 9.2 (SAS Institute) using PROC REG procedure with stepwise selection. The limit for model entry was set at  $p = 0.3$  and at  $p = 0.15$  for variables to stay in the model. Studentized residuals and Cook's D were checked for outliers or cases that might influence the model. Collinearity was tested by the use of VIF (variance inflation factor).

**Table 14: Predictors for inclusion in regression model 'impaired lying down' using Pearson Correlation Coefficient ( $r_p$ ) and point biserial correlation coefficient ( $r_{pb}$ ).**

Predictor	entity	r	p
Cubicle type	Deep bedded vs. others	-0.438	0.036
Presence of bedding retainer	no / yes	-0.304	0.158
Presence of a brisket board	no / yes	-0.418	0.041
Height of loose litter in the front part of the cubicle	cm	-0.282	0.193
Hard cubicle flooring (front part of the cubicle)	no / yes	0.394	0.063
Bedding material includes straw	no / yes	-0.440	0.036
Compliance of cubicle width	%	-0.255	0.239
Compliance of neck rail diagonal	%	-0.251	0.248
Compliance of head space	%	-0.377	0.076
Partition length	cm	-0.451	0.031
Partition height	cm	-0.295	0.172
Space between bedding retainer and cubicle partition	cm	-0.428	0.041
Cow-cubicle-ratio	Cows per cubicle	0.268	0.217

### 3.3.3. Results

#### 3.3.3.1. Cubicle characteristics and management factors

For results on cubicle and management factors see chapter 3.1.3.1.

Another interpretation of fulfilment of recommendations, according to Veissier et al. (2004) considering 90- 110 % compliance as adequate, shows that cubicle width, resting length, neck rail horizontal, neck rail height, total length and head space can be contemplated as sufficient on 26, 73, 39, 30, 78 and 9 % respectively. The



farmers stated that they spent on average 0.406 minutes per cubicle and day for cubicle maintenance.

### 3.3.3.2. Behavioural measures

Mean duration of lying down on the 23 investigated farms was  $5.8 \pm 0.6$  seconds (range of farm means: 5.0 – 7.6 seconds). Four farms had an average lying down duration below 5.2 seconds (limit of normal duration of lying down according to Welfare Quality<sup>®</sup> Consortium (2009)), four farms had an average duration above 6.3 seconds. Collisions during lying down occurred on average in  $45.8 \pm 18.5$  % of the observed lying down events (range of farm means: 13.3 % - 73.3 %). Interrupted events occurred in  $5.1 \pm 5.6$  % of all observed cases. On nine farms no interruptions and on eleven farms more than 5.0 % of interruptions were registered (at maximum 18.4 %). 'Impaired lying down' was shown in  $57.0 \pm 18.5$  % of all observed cases.

### 3.3.3.3. Multivariable analyses of impacts on lying down behaviour

The model for 'impaired lying down' had an explanatory value of 41.3 % ( $F=4.45$ ,  $p=0.0157$ ). Three out of 13 predictors were included in the model. The model (Table 15) predicted that each cm increase in partition length ( $t=-2.31$ ,  $p=0.0322$ ) came along with 0.8 % less impaired lying down events. Even though not significant, the factors compliance regarding cubicle width ( $t=-1.76$ ,  $p=0.0937$ ) and presence of bedding that included any type of straw ( $t=-1.69$ ,  $p=0.1076$ ) contributed to the model. The use of straw predicted a decrease of about 11.9 % impaired events. Each extra percent of compliance regarding cubicle width was associated with 2.0 % less impaired lying down events.

One possibly influencing case was found, but only slightly exceeded the limit (Cook's  $D = 1.167$ ) and, therefore, remained in the model. Collinearity was sufficiently low ( $VIF = 1.05- 1.12$ ).

**Table 15: Final model of stepwise regression (PROC REG stepwise, SAS 9.2) with the dependent variable 'percentage of impaired lying down' including 13 predicting variables (n=23).**

predictor variables	t -value	p - value	parameter estimate	partial R <sup>2</sup>
partition length	-2.31	0.0322	-0.8072	0.2044
compliance of cubicle width	-1.76	0.0937	-1.9760	0.1203
bedding material includes straw	-1.69	0.1076	-11.8668	0.0882

### **3.3.3.4. Correlations between behavioural measures and cleanliness**

No significant correlations were found between the percentages of impaired lying down events and the mean udder score ( $r_p=-0.296$ ,  $p=0.170$ ), the percentages of dirty teats ( $r_p=0.073$ ,  $p=0.739$ ) or dirty teat tips ( $r_p=0.141$ ,  $p=0.522$ ). However, farms with higher rates of 'impaired lying down' had less animals with dirty to very dirty udders ( $r_s=-0.447$ ,  $p=0.033$ ).

### **3.3.4. Discussion**

Cubicle adjustment and other cubicle characteristics are of prime importance for cow welfare (Veissier et al., 2004). In the past, experimental studies repeatedly investigated the influence of single cubicle measures on lying down behaviour and udder cleanliness. This is the only epidemiological study that quantitatively investigated lying down behaviour in combination with udder cleanliness while taking into account body dimensions of the cows. The main motivation of this study was to achieve more insight into the potential dilemma between measures that serve to increase cow welfare in terms of resting comfort on the one hand and teat cleanliness on the other.

For the assessment of cow welfare with regard to resting behaviour we followed the proposal of Winckler et al. (2003) to take into account prolonged lying down durations, interrupted lying down movements and forceful hits against cubicles. Even though rising behaviour and specific lying positions would have provided additional information about lying comfort we refrained from including these measures due to feasibility and reliability reasons. Veissier et al. (2004) reported from their study of 70 French farms an average proportion of 12.5 % interrupted lying down movements which was considerably higher than in the present study (more than twice as much). This may correspond to the lower proportion of French farms fulfilling common recommendations, especially regarding cubicle length (see chapter 3.1.4.), but other reasons such as different observation methods and observers can not be ruled out. The average lying down duration in our investigation was comparable to the values obtained in other investigations using the same definition (Bockisch, 1991; Wechsler et al., 2000; Hörning, 2003a; Martiskainen et al., 2007). Applying the limit for a normal lying down duration of 5.2 seconds that was proposed by the Welfare Quality® Consortium (2009), 15 of the investigated 23 herds were judged to have moderate to serious problems with lying down duration. Additionally, the Welfare Quality® Consortium (2009) considers a maximum of 20 % collisions during lying down on herd level as acceptable and judges farms with more than 30 % collisions to have serious problems. Only three farms were below the acceptable limit of 20 %.

In accordance with these results and with Veissier et al. (2004) as well as Faull et al. (1996) we found that many farms did not meet the recommendations for cubicle

dimensions in relation to the cow's sizes. While Veissier et al. (2004) had used the CIGR standards (CIGR, 1994) as a reference, we had decided for the recommendations of Bartussek et al. (2008), mainly based on practical considerations, because they provide recommendations also for the neck rail positioning which are not given by CIGR (1994). The recommendations do, however, only differ regarding the additional manoeuvring space, requiring 21 cm (Bartussek et al., 2008) instead of 15 cm (CIGR, 1994).

The general bias towards restrictive cubicle conditions and impaired lying down behaviour over all investigated farms needs to be kept in mind when interpreting our results regarding potentially influencing factors on lying down comfort. With respect to the percentages of impaired lying down behaviour the final regression model had an explanatory value of less than 50 % which means that a large proportion of the variation between farms remains unexplained.

One factor, amongst others, that possibly contributed to the unexplained variation is lameness, which is associated with inadequate lying areas (Faull et al., 1996). Further health problems possibly might have influenced lying down movement and have led to interruptions or prolonged lying down events due to the expectation of discomfort or pain. Furthermore, the only significant influencing factor identified is difficult to explain. Experimental work concerning partition length, i.e. clear space between the rear of the partition and the end of the cubicle, suggests that lack of clear space impairs lying down, especially with regard to collisions (Hörning, 2003a). The reason for this is the sideward movement of the cow's rear during lying down (Ceballos et al., 2004). Blom et al. (1984) underline that during the last sequence of the lying down movement when the cow's body falls down, hits against partitions can produce pressures of up to 50 kg and even 190 kg at maximum. In the present study, however, increasing partition length was associated with less impaired lying down behaviour. Possibly partition shapes have developed further in the last years. Indeed, partition length and height were positively correlated on our study farms ( $r_p=0.683$ ,  $p=0.000$ ), leading to a bigger zone of clear space for pelvis freedom. Presumably the shape of the partition and its positioning within the stall is more important than its length per se. However, although the partition type was recorded, no reasonable classification could be created that more truly reflected pelvis freedom during lying down.

The two further factors contributing to the model tended only to affect lying down behaviour, though in expected directions. Increasing cubicle width can be expected to provide more space for the sideward movement during lying down mentioned above (Ceballos et al., 2004).

Also positive effects of straw bedding have been reported previously (Hörning, 2003a). Even though straw was partly mixed with other components like wood

shavings or lime its presence may provide a cushioning effect, especially for the carpal joints, and reduce slipperiness of the cubicle surface.

One reason for the restrictive cubicle dimensions in practice may be the ongoing increase of body dimensions due to breeding, as Troxler (1987) already stated in 1987. Compared to a study on Holstein cows (unfortunately including cross breeds) that was conducted about 20 years ago (Bockisch, 1991), the average diagonal body length increased about 7.8 % since that time in relation to our results.

Another reason may be a deliberate choice of restrictive cubicle dimensions in order to decrease the risk of soiling (Tucker et al., 2004). In fact, the significant correlation between lying down comfort and percentages of dirty udders conform to this expectation. However, when looking at teat and teat tip cleanliness no such relationship could be found. It appears reasonable that with regard to mastitis risks and needed cleaning time prior to milking teat and teat tip cleanliness is of higher importance than of general udder cleanliness. However, this question needs further investigation in the future.

### **3.3.5. Conclusion**

The relationship between cubicle characteristics and lying down behaviour apparently is very complex, so that it is difficult to identify single influential factors that are valid for all farm situations. Cubicle dimensions in practice are often inadequate with regard to the body dimensions of the cows, leading to impaired lying down behaviour, whereas teat cleanliness is still unsatisfactory. However, only weak indications for a dependence between lying down difficulties and udder soiling can be found. For teat or teat tip soiling which appear to be more relevant in terms of disease risks and labour demands there is even no evidence for an association.

## 4. General discussion

Although feasible and reliable resting parameters for an on-farm welfare assessment could be identified, the choice of measures is not completely satisfactory and further research in this area is certainly needed. For instance it proved not to be feasible to record promising parameters such as rising (Lidfors, 1989; Chaplin and Munksgaard, 2001) within a limited time during a farm visit. The space consuming rising movement was expected to provide information on the sufficiency of head lunging space. Furthermore restrictive neck rail positioning was often reported to impair getting up movement (Martiskainen et al., 2007; Bernardi et al., 2009). Taking into account the predominant situation on the farms of the epidemiological study that especially neck rail positioning largely deviated from recommendations, this measure probably would have provided important information. This is also true for the duration of the preparatory phase of lying down which was found to be another good indicator for lying down difficulties (Krohn and Munksgaard, 1993; Herlin, 1997; Wechsler et al., 2000; Hörning, 2003b), but was problematic regarding feasibility. The parameter 'collisions during lying down' particularly showed that precise definitions as well as easily assessable measures are needed to achieve good inter-observer-reliability.

Even though 'lying partly or completely outside the lying area' was found to be a feasible and reliable measure that reflects certain aspects of the adequacy of the lying area, regression analysis in the epidemiological study unfortunately did not provide a valid model. This might have been due to the relatively small sample size or the influence of other factors that were assessed but not included in the analysis (e.g. partition type), because it was found difficult to classify them in a meaningful way. This highlights that the conditions found in practice are so many and diverse that it is sometimes difficult to identify a limited number of factors that are influential in any actual combination of factors on most farms. Both exacerbating and compensating interactions between different factors are conceivable. A compensating interaction would for example be a cubicle short in length, but of sufficient width, so that cows can compensate the one deficiency by adopting a diagonal lying position (Veissier et al., 2004), possibly leading to less cows lying partly outside the lying area. Overall the consideration of only single aspects of the cubicle probably oversimplifies the matter.

The timing of resting observations (half an hour after finishing of cow measurements) furthermore might have disturbed the daily routine. While it was certainly a good time to record a sufficient number of lying down events, it possibly did not allow to catch a representative proportion of the lying positions outside the lying area that might have been usual for the individual farm.

Concerning udder, teat or teat tip cleanliness it was found that on herd level udder cleanliness on the one hand is not associated with teat or teat tip cleanliness on the other hand. This is of importance for future studies on this matter. It can be expected that in terms of health risks and labour demands the cleanliness of teats or teat tips is more important than the cleanliness of the rest of the udder.

Following the methodological considerations discussed above the second part of the thesis focused on the influence of cubicle characteristics and management factors on particularly lying down behaviour as a measure of resting comfort, and additionally teat and teat tip cleanliness. Specific emphasis was laid on the inclusion of the body dimensions of the cows when evaluating cubicle dimensions.

Although experimental studies repeatedly found associations between cleanliness or lying behaviour on the one hand and cubicle characteristics on the other, epidemiological studies often could not confirm these relationships. Complex interactions not only between the different resource measures as mentioned above, but also between resource measures and the condition of the animals (e.g. health, rank, age, stage of lactation/gestation) likely will have affected the results. For instance, a higher proportion of lame animals in the herd caused by nutritional or infectious problems might distort farm values regarding lying down due to their health-related difficulties, while this value is expected to reflect lying comfort related to the adequacy of resources. However, under usual conditions it can be expected that impaired lying down behaviour to a large degree reflects inadequate resources which simultaneously pose an increased risk for lameness (Dippel et al., 2009a; Dippel et al., 2009b). Nevertheless, the case of the present study of a relatively newly built cubicle house with generous cubicle dimensions with cows that were transferred from tied stalls is another example of the animal based measure 'lying down duration' not reflecting the actual, but here the historical housing conditions, even though the transfer was already more than one year ago. For the search of risk factors for impaired lying comfort this farm was clearly not suitable and it was therefore discarded from all other analyses.

Another possible reason for clearer results in experimental compared to epidemiological studies are the often more extreme conditions investigated experimentally. For example, Bernardi et al. (2009) who reported that less restrictive neck rail positions led to dirtier cubicles and udders, compared positions of 130 cm and 190 cm away from the rear curb (at a height of 118 cm, and without reference to body dimensions). Both are extreme positions compared to our results ( $155 \pm 9.3$  cm). Thus, variation between farms in our study was probably too low to reveal differences. At the same time this difference between experimental and on-farm conditions sheds some doubt on the applicability of experimental findings for the practice.

However, considering the general problems discussed above, it was especially unfortunate that due to the thorough selection for low within-farm variation regarding cubicle characteristics, the resulting sample size was rather small.

This was clearly a problem for the finding of influencing factors on resting comfort. Apart from the fact that the final regression models explained slightly less variation concerning lying down behaviour between farms than concerning cleanliness, they each included only one significant factor and some of the contributing factors were difficult to explain. On the first sight, the final regression model regarding 'mean lying down duration' appears even to have a higher explanatory value (54.8 %) compared to the model concerning 'impaired lying down (41.3 %). However, it must be taken into account that the first analysis was quite exploratory with a lower limit for model entry ( $p=0.5$ ) and removal ( $p=0.2$ ) compared the usual setting of  $p=0.3$  for model entry and at  $p=0.15$  for variables to stay in the model that was used in the other multivariable regression analyses. Still, results concerning influencing factors on lying down behaviour together point into the direction that deep bedded cubicles help to improve resting comfort and that apparently both, the aspect of softness and of reduced abrasiveness may play a role in that. Additionally, increased freedom of movement appears to have some beneficial effects, although it is not possible to clearly identify single factors of cubicle dimensions that are most relevant, probably due to the complex interaction effects already discussed.

Regarding teat and teat tip cleanliness the final regression models clearly showed that both management and housing conditions are influential. While expectations were confirmed that a certain increase in teat and teat tip soiling can be expected with increasing cubicle length, concurrently influencing factors were identified that can be expected to favour both, cleanliness and resting comfort. They are the use of deep bedded cubicles as well as good cubicle maintenance and achievement of good quantities of litter in the rear of the cubicle.

Looking at the welfare state regarding resting comfort or the welfare risk regarding udder disease on the investigated farms, it appears that both were not at a satisfactory level. Lying down took on average 5.8 seconds. During on average  $45.8 \pm 18.2$  % of all lying down events at least one collision occurred, whereas  $5.4 \pm 5.6$  % lying down attempts were interrupted. Thus, on average  $57.0 \pm 18.5$  % of all observed lying down events were impaired, i.e. they either took longer than 6.3. sec, were interrupted or associated with collisions. The percentage of cows lying partly or completely outside the lying area was on average  $38.8 \pm 15.8$  %. The amount of dirty and very dirty teats (score 2 and 3) was  $56.0 \pm 10.3$  % and of dirty teat tips  $41.2 \pm 11.4$  %.

Hence, the fact that recommendations for cubicle dimensions with regard to body sizes of the cows were frequently not met, whereas teat and teat tip cleanliness was

still unsatisfactory raises the question if lowering cubicle lengths would be an adequate method to improve udder hygiene on these farms. Instead, improved management and the use of deep bedded cubicles appears to be a more efficient approach to reach cleaner teats and teat tips and better resting comfort simultaneously.

However, a great number of open questions remain. Future tasks range from methodological issues such as identification of more comprehensive measures of resting comfort, of more appropriate approaches to take into account the complex interactions between cubicle characteristics (such as 3-D kinematic evaluation as used by Ceballos et al. 2004) to further investigations into the actual risk of teat or teat tip soiling for mastitis. In two studies evidence was found for a positive association between udder and respectively cubicle soiling and mastitis rate (Schukken et al., 1990; Schreiner and Ruegg, 2003). Most other studies investigating the effect of environmental soiling stop at the teat skin (e.g. Hogan and Smith, 1997; Zdanowicz et al., 2004). However, it is likely that further environmental factors additionally influence immunity or pathogen exposition and thereby affect the resulting overall mastitis risk (Schreiner and Ruegg, 2003; Reneau et al., 2005).



---

## 5. Conclusion

The measures 'duration of lying down', 'collisions during lying down' and 'lying partly or completely outside lying area' were found to be feasible and reliable animal based welfare measures regarding resting behaviour for the use in on-farm data collection. For the assessment of health risks regarding udder infections it is recommended to record teat and teat tip cleanliness as it was found that these measures are unrelated to the cleanliness of the rest of the udder on herd level.

Assessment of these measures in 23 Holstein Friesian dairy herds with cubicle housing in Central Germany revealed unsatisfactory results regarding lying comfort and teat cleanliness. At the same time recommendations regarding cubicle dimensions were often not met. Even under these restrictive conditions, cubicle length was found to be positively related to soiling levels. However further feasible and effective measures identified related to good management and specifically litter management in the cubicles. Also deep bedded cubicles yielded advantages in this regard. Influencing factors regarding lying down behaviour could not as clearly be identified as for cleanliness. While certain cubicle characteristics relating to cubicle floor quality and freedom of movement potentially affect lying down duration in expected directions, a considerable proportion of variance remains unexplained. The relationship between cubicle characteristics and lying down behaviour apparently is very complex, so that it is difficult to identify single influential factors that are valid for all farm situations. Further research is necessary in this regard. No evidence was found for associations between lying down difficulties and teat or teat tip soiling on herd level.

Altogether, in agreement with earlier studies it was found that cubicle dimensions in practice are often inadequate with regard to the body dimensions of the cows, leading to impaired lying down behaviour, whereas teat cleanliness is still unsatisfactory. Based on the results of the present study the use of deep bedded cubicles can be recommended as well as improved management with special regard to cubicle and litter maintenance.

## 6. Summary

Resting behaviour is important for the regeneration, well-being and performance of dairy cows. Cubicle housing is the most frequent system for keeping high yielding dairy cows. However, inadequate cubicles can restrict resting comfort, coming along with discomfort, stress, pain and even injuries or lameness. This thesis aimed to identify reliable and feasible resting measures and investigated the potential discrepancy between udder or teat cleanliness and good resting comfort.

Altogether 15 resting measures were investigated in terms of feasibility, inter-observer reliability (IOR) and consistency of results per farm over time. They were recorded during three farms visits (approximately 60 and a further 120 days apart) on 35 farms in Austria and Germany with cubicle, deep litter and tie stall systems. Seven measures occurred too infrequently (<1/hour and 1 % respectively) to allow reliable recording within a limited observation time. IOR was generally acceptable to excellent (Spearman's  $r=0.7-1.0$ ), except for 'collision during lying down' with a PABAK of 0.2 ( $n=15$ , observed on farm). However, after improvement of the definition IOR was good (0.78,  $n=65$ , observed from videos). Only three measures were acceptably repeatable over time, 'duration of lying down' (Kendall's  $W=0.78$  for a minimum of 6 recorded occurrences), 'percentage of collisions during lying down' ( $W=0.95$ ) and 'percentage of cows lying partly or completely outside lying area' ( $W=0.87$ ). These measures are evaluated as suitable animal based welfare measures regarding resting behaviour in the framework of an on-farm welfare assessment protocol. Although further correlation analyses revealed that the measures 'rising', 'duration of lying down' and 'abnormal incidences' apparently provide different information on different aspects of resting comfort, within the limitations of an on-farm assessment only lying down measures are recommended for feasibility and reliability reasons. The different lying down measures 'herd mean of lying down', the 'proportion of normal lying down events' (< 5.2 seconds) and the 'proportion of prolonged lying down' (> 6.3 seconds) were found to be highly correlated and, thus exchangeable.

The second part of the thesis comprises a cross-sectional study on resting comfort and cow cleanliness carried out in 23 Holstein Friesian dairy herds (in one analysis 24 herds) with very low within-farm variation in cubicle measures. The aim was to identify potentially influencing housing and management factors concerning teat and teat tip soiling and resting comfort. Information was collected through direct recording and farmers' interviews. Height at withers, shoulder width and diagonal body length were measured in 79-100 % of the cows in each herd. Based on the 25 % largest animals, compliance with recommendations for cubicle measures was calculated, which was generally rather low. No significant correlation was found between udder

soiling and teat or teat tip soiling on herd level. Stepwise regression was used to find predictors for the percentage of dirty teats and of dirty teat tips. The final model on dirty teats explained 58.5 % of the variance and contained four factors ( $F=6.34$ ,  $p=0.0023$ ). Teat dipping after milking ( $t=-3.21$ ,  $p=0.0048$ ) which might be associated with an overall clean and accurate management style, deep bedded cubicles ( $t=-2.42$ ,  $p=0.0265$ ), increasing cubicle maintenance times ( $t=-2.58$ ,  $p=0.0187$ ) and decreasing compliance concerning total cubicle length ( $t=2.33$ ,  $p=0.0317$ ) predicted lower teat soiling. The final model concerning teat tips explained 46.0 % of the variance and contained three factors ( $F=5.39$ ,  $p=0.0075$ ). Increasing litter height in the rear part of the cubicle ( $t=-2.89$ ,  $p=0.0094$ ) and increased alley soiling ( $t=-1.89$ ,  $p=0.0790$ ) which is difficult to explain, predicted for less soiled teat tips, whereas increasing compliance concerning resting length ( $t=2.12$ ,  $p=0.0470$ ) was associated with higher percentage of dirty teat tips.

The dependent variable 'duration of lying down' was analysed using again stepwise regression. The final model explained 54.8 % of the total variance ( $F=5.76$ ,  $p=0.0033$ ). Lying down duration was significantly shorter in deep bedded cubicles ( $F=11.48$ ,  $p=0.0026$ ). Further explanatory, though not significant factors in the model were neck-rail height ( $F=2.75$ ,  $p=0.1121$ ), deep bedding or comfort mattresses versus concrete floor or rubber mats ( $F=2.07$ ,  $p=0.1658$ ) and clearance height of side partitions ( $F=3.13$ ,  $p=0.0930$ ). In the attempt to create a more comprehensive lying down measure, another analysis was carried out with percentage of 'impaired lying down' (i.e. events exceeding 6.3 seconds, with collisions or being interrupted) as dependent variable. The explanatory value of this final model was 41.3 % ( $F=4.45$ ,  $p=0.0157$ ). An increase in partition length ( $t=-2.31$ ,  $p=0.0322$ ), in compliance concerning cubicle width ( $t=-1.76$ ,  $p=0.0937$ ) and the presence of straw within bedding ( $t=-1.96$ ,  $p=0.1076$ ) predicted a lower proportion of impaired lying down. The meaning of the factor partition length is difficult to interpret, but partition length and height were positively correlated on the study farms, possibly leading to a bigger zone of clear space for pelvis freedom. No associations could be found between impaired lying down and teat and teat tip soiling.

Altogether, in agreement with earlier studies it was found that cubicle dimensions in practice are often inadequate with regard to the body dimensions of the cows, leading to high proportions of impaired lying down behaviour, whereas teat cleanliness is still unsatisfactory. Connections between cleanliness and cow comfort are far from simplistic. Especially the relationship between cubicle characteristics and lying down behaviour apparently is very complex, so that it is difficult to identify single influential factors that are valid for all farm situations. However, based on the results of the present study the use of deep bedded cubicles can be recommended as well

as improved management with special regard to cubicle and litter maintenance in order to achieve both better resting comfort and teat cleanliness.

## 7. Ausführliche Zusammenfassung

### **Guter Liegekomfort und akzeptable Verschmutzung – ein unlösbares Problem?**

Einfluss von Liegeboxengestaltung, Managementfaktoren und Tiergrößen auf den Liegekomfort und die Euterverschmutzung bei Milchkühen der Rasse Deutsche Holstein

Guter Liegekomfort aufgrund großzügig bemessener Liegeboxen steht im Verdacht mit inakzeptabler Euterverschmutzung einherzugehen. Experimentelle Untersuchungen belegen dieses in der Praxis diskutierte Problem; epidemiologische Ansätze bleiben diesen Nachweis schuldig. Ziel der vorliegenden Arbeit war es, Zusammenhänge zwischen Liegekomfort und Euterverschmutzung in Abhängigkeit von Liegeboxenmerkmalen und dem Management unter Berücksichtigung der Tiergrößen aufzuzeigen.

Im ersten Teil dieser Arbeit wurden zu diesem Zweck zuverlässige Beurteilungsgrößen für die Tiergerechtigkeit auf Praxisbetrieben im Hinblick auf das Ruheverhalten eruiert. Praktikabilität, eine gute Beobachterübereinstimmung und Wiederholbarkeit über die Zeit waren die drei entscheidenden Selektionskriterien.

Im zweiten Teil kamen die ermittelten Messgrößen zum Einsatz. Mit dem Zweck, potentielle Einflussfaktoren bezüglich des Liegekomforts und der Euterverschmutzung zu ermitteln, wurden auf Praxisbetrieben Daten zum Liegeverhalten, der Verschmutzung, der Aufstallung und zu Managementfaktoren erhoben. Hierbei spielte auch die Erfassung der Tiergrößen eine wichtige Rolle, da adäquate, an die Tiergrößen angepasste Boxen ausreichenden Liegeplatz bei geringer Verschmutzung bieten sollen.

Zur Beurteilung der Reliabilität von unterschiedlichen Liegeverhaltensparametern wurden Messgrößen herangezogen, welche innerhalb eines einmaligen Betriebsbesuches unter geringem Zeitaufwand erhoben werden konnten. Sie wurden auf 35 Milchviehbetrieben, 18 aus Deutschland und 17 aus Österreich, angewandt. Es wurde zwischen Liegeboxenlaufställen (16 Betriebe), freien Liegeflächen (7 Betriebe) und Anbindehaltung unterschieden. Im Zeitraum zwischen August 2005 und April 2006 wurde jeder Betrieb nach dem Erstbesuch nach 60 und abermals nach 180 Tage ( $\pm 10$  Tage) ein weiteres Mal aufgesucht. Zeitliche Einschränkungen machten es erforderlich, dass die Untersuchungen in den Anbindeställen schon am 120. statt dem 180. Tag nach dem Erstbesuch wiederholt wurden. Insgesamt 15 Messgrößen wurden ausgewählt: 1.) Aufstehdauer, 2.) Abliegedauer, 3.) Anschlagen, 4.) Ausrutschen, 5.) Unterbrechungen eines Abliege- bzw. Aufstehvorganges, 6.) pferdeartiges Aufstehen, 7.) Aufstehvorgang mit der Hinterhand zuerst, 8.) ganz oder teilweise außerhalb des Liegebereiches liegen, 9.) Liegen mit Kopf abgelegt, 10.) Liegen mit Hinterbein gestreckt, 11.) Seitenlage, 12.)

Sitzen, 13.) umgekehrt in der Box liegend, 14.) Synchronität des Liegens, 15.) Stehen im Liegebereich.

Die Verhaltensbeobachtungen wurden begonnen, wenn mindestens 75 % der Herde vom Morgenmelken in den Stall zurückgekehrt waren. Die Abliege-/Aufstehdauer wurde mit einer Stoppuhr erfasst, wobei die Beobachtung von jeweils 20 Vorgänge geplant war. Es wurde über den Zeitraum von ca. vier Stunden beobachtet, wobei im Intervall von 14-30 Minuten (in Abhängigkeit von der Herdengröße) eine Punkt-Übersichtsbeobachtung durchgeführt wurde.

Sieben Messgrößen wurden aufgrund des seltenen Auftretens (<1/h bzw. 1 %) ausgeschlossen. Der Beobachterabgleich zwischen zwei Personen, der mittels Video- und Fotoaufnahmen durchgeführt wurde, lieferte akzeptable bis sehr hohe Übereinstimmungen (Spearman's Rho = 0,7- 1,0) mit Ausnahme des Anschlagens während des Aufsteh- bzw. Abliegevorgangs. Hier lag der PABAK (Prevalence Adjusted Bias Adjusted Kappa) nur bei 0.2 (N = 15; Direktbeobachtung). Nachdem die Definition für diese Messgröße präzisiert worden war, konnte eine gute Übereinstimmung gefunden werden (PABAK = 0,78; Videobeobachtung). Die Wiederholbarkeit der Ergebnisse zu unterschiedlichen Zeitpunkten reduzierte die Anzahl der verbleibenden Messgrößen. Die ‚Abliegedauer‘, ‚Prozent Kühe, die während des Abliegevorgangs anschlagen‘ und der Parameter ‚Prozent Kühe, die ganz oder teilweise außerhalb des Liegebereichs liegen‘ zeigten eine hohe Korrelation (Kendall's W = 0,78; 0,95; 0,87). Diese drei Messgrößen können innerhalb kurzer Zeit erlernt werden, zeigen eine gute Beobachterübereinstimmung und eine zufriedenstellende Wiederholbarkeit zu unterschiedlichen Zeitpunkten.

Im zweiten Abschnitt dieser Arbeit wurden die Verbindungen zwischen dem Liegekomfort und der Euterverschmutzung in Abhängigkeit von den Tiergrößen untersucht. In den Winterstallhaltungsperioden von März 2008 bis April 2009 wurden Daten auf Betrieben in Hessen, Niedersachsen und NRW erhoben. Insgesamt konnten nur 24 bzw. 23 Betriebe in die Endauswertung aufgenommen werden, da nur diese die folgenden Auswahlkriterien erfüllt haben. Um eine aussagefähige Auswertung durchführen zu können, wurden ausschließlich Betriebe mit einheitlichem Boxentyp, allenfalls gering abweichenden Boxenlängen und –breiten (15 bzw. 10 cm) sowie mit einheitlichem Liegeuntergrund einbezogen. Die Untersuchung wurde auf Holsteinkühe beschränkt, da gut die Hälfte der Tiere, die unter Milchleistungsprüfung stehen, der Rasse Holstein (Deutscher Holstein Verband e.V. 2007) angehören und rassebedingte Größenschwankungen vermieden werden sollten. In Abhängigkeit von der Herdengröße wurden bei mindestens 79 % aller Tiere die schräge Rumpflänge (schrR), die Widerristhöhe (WH) und die Schulterbreite (SB) gemessen. Die augenscheinlich größten Tiere wurden in jedem Fall in die Messungen einbezogen, da für die Berechnung der zu empfehlenden

Boxenmaße (Boxenlänge, -breite und Nackenriegellage) vor allem die 20 - 25 % größten Tiere von Interesse sind (CIGR, 1994; Bartussek et al., 2008).

Vor dem Morgenmelken wurden alle Tiere der Herde auf Sauberkeit (Hinteransicht, Hinterbein, Bauch, Euter, Zitzen) überprüft. Für das Euter kam ein fünfstufiges Schema zur Anwendung (0 = sauber - 4 = stark verschmutzt), für die Zitzen ein vierstufiges (0 = sauber - 3 = stark verschmutzt) sowie für die Zitzenkuppen ein zweistufiges (0 = sauber, 1 = verschmutzt). In der Zwischenzeit war eine zweite Person damit beschäftigt, die Liegeboxenparameter zu erheben. Alle Steuerungseinrichtungen und weitere Kriterien wie Liegeboxenverschmutzung und -härte wurden untersucht. Die Verschmutzung der Gänge im Boxenlaufstall wurde mittels eines 100 x 100 cm großen Wurfrahmens ermittelt, der in neun gleich große Quadrate aufgeteilt war. Alle neun Teilabschnitte wurden einzeln betrachtet. Wenn sich mehr als 50 % des Segmentes von Kot oder Gülle bedeckt zeigten, wurde der Abschnitt als schmutzig klassifiziert. Die Anzahl der verschmutzten Segmente wurde anschließend summiert (0 = alles sauber bis 9 = alle Segmente verschmutzt). Das gleiche Verfahren wurde auch für Nässe vollzogen.

Mit den Verhaltensbeobachtungen wurden nach dem Ende der Vermessung der Tiere begonnen. Frühestens eine halbe Stunde nachdem die letzte Kuh aus der Fixierung entlassen wurde, wurden halbstündlich Punkt-Übersichts-Beobachtungen durchgeführt, um unter anderem den Anteil der fressenden, liegenden und stehenden Tiere bestimmen zu können. Im Zuge dieser Scans wurden unterschiedliche Liegepositionen erhoben. Mittels Stoppuhr wurde die Dauer der Abliegevorgänge erfasst und zusätzlich wurde Anschläge an der Boxeneinrichtung erhoben.

Am Ende jedes Betriebsbesuches wurden mit Hilfe eines Standardfragebogens allgemeine Betriebsdaten sowie Managementfaktoren ermittelt. Unter anderem wurde die tägliche Melkroutine, der Zeitaufwand für die Boxenreinigung und -pflege sowie die Einstreuhäufigkeit, -art und -menge erfragt.

Um die Relation von Tier- zu Boxengrößen zu bestimmen, wurde die Sollwerterfüllung bezüglich der Boxendimensionierung errechnet. Dazu wurde der vorhandene Ist-Zustand auf dem Betrieb mit den nach Bartussek et al. (2008) empfohlenen Liegeboxenabmessungen, welche auf die Tiergrößen Bezug nehmen, ins Verhältnis gesetzt. Mit Hilfe einer schrittweisen Regression (SAS 9.2) wurden Wirkungsvariablen ermittelt, welche die Zitzen- und Zitzenkuppenverschmutzung auf 23 Betrieben beeinflusst haben. Der Erklärungswert des Modells, in das 17 bzw. 14 unabhängige Variablen für den ‚Anteil verschmutzter bis stark verschmutzter Zitzen‘ (Note 2 und 3) bzw. ‚Anteil verschmutzter Zitzenkuppen‘ einfließen, lag bei 58,5 % ( $F=6,34$ ;  $p=0,0023$ ) bzw. 46,0 % ( $F=5,39$ ;  $p=0,0075$ ). Das Dippen (inkl. besprühen) der Zitzen nach dem Melken ( $t=-3,21$ ;  $p=0,0048$ ) war mit einem geringeren Anteil dreckiger Zitzen verbunden. Ein höherer Zeitaufwand für das Einstreuen, die

Reinigung und Pflege der Boxen ( $t=-2,58$ ;  $p=0,0187$ ) sowie das Vorhandensein von Tiefboxen ( $t=-2,42$ ;  $p=0,265$ ) sagten ebenfalls einen geringeren Anteil verschmutzter Zitzen vorher. Im Gegensatz dazu führten höhere Sollwerterfüllungen für die Gesamtboxenlänge ( $t=2,33$ ;  $p=0,0317$ ) zu einem größeren Anteil verunreinigter Zitzen.

Eine verminderte Zitzenkuppenverschmutzung wurde bei höherer Einstreu im hinteren Liegeboxenbereich ( $t=-2,89$ ;  $p=0,0094$ ), wo das Euter während des Ruhens platziert ist, prognostiziert. Eine höhere Sollwerterfüllung für die effektive Liegelänge ( $t=2,12$ ;  $p=0,0457$ ) sagte einen erhöhten Anteil verschmutzter Zitzenkuppen voraus. Ein nicht signifikanter, Einfluss, der aber zum Erklärungswert des Modelles beitrug, allerdings kaum zu erklären ist, war eine geringere Zitzenkuppenverschmutzung bei erhöhter Laufgangverschmutzung ( $t=-1,86$ ;  $p=0,0790$ ).

Es zeigte sich, dass die Verschmutzung der Zitzen- und Zitzenkuppen selbst unter relativ restriktiven Bedingungen (in Relation zur Körpergröße der Kühe) noch unbefriedigend ist. Eine Verbesserung der Sauberkeit, ohne dabei das Verhalten der Tiere negativ zu beeinträchtigen, konnte durch gutes Management erzielt werden. Die Tatsache, dass Tiefboxen mit geringerer Verschmutzung der Zitzen einhergingen verdient Beachtung. Beide Regressionsmodelle zur Verschmutzung lieferten ähnliche, wenn auch nicht identische Prädiktoren, daher ist anzunehmen, dass die Verschmutzung der einzelnen Euterregionen unterschiedliche Ursachen hat. Die geringen Korrelationen zwischen Euter-, Zitzen- und Zitzenkuppenverschmutzung sind ein wichtiger Hinweis für zukünftige Untersuchungen, der Wahl der richtigen Euterregion in Abhängigkeit von der Fragestellung mehr Aufmerksamkeit zu schenken.

Der letzte Teil dieser Arbeit beschäftigt sich mit dem Abliegeverhalten. Zwei unterschiedliche Analysen wurden durchgeführt. Als erstes wurden mögliche Einflussfaktoren auf die mittlere Abliegedauer pro Betrieb für 24 Betriebe untersucht. Der Mittelwert für das Abliegen betrug 5,81 Sekunden (4,96- 7.64 Sekunden). Der Grenzwert für den Eingang/Verbleib im Modell wurde, aufgrund des explorativen Charakters dieser Analyse auf  $F_{in}=0.5$  bzw.  $F_{out}=0.2$  gesetzt. Das Modell der Regressionsanalyse (SAS, proc reg stepwise), in das 19 unabhängige Variablen eingeflossen sind, konnte 54,8 % der Gesamtvarianz erklären ( $F=5.67$ ;  $p=0.0033$ ). Kürzere Abliegezeiten wurden für Tiefboxen ( $F=11,48$ ;  $p=0,0026$ ) vorausgesagt. Weitere erklärende Faktoren waren die Sollwerterfüllung der Nackenriegelhöhe ( $F=2,75$ ;  $p=0,1121$ ), der Liegeuntergrund ( $F=2,07$ ;  $p=0,1658$ ) sowie die Höhe der Seitenabtrennung ( $F=3,13$ ;  $p=0,0930$ ). Ein erheblicher Teil der Varianz konnte durch das Modell nicht erklärt werden, auch wenn gezeigt wurde, dass Liegeboxencharakteristika wie z.B. ein Liegeuntergrund aus Tiefstreu bzw. Komfortmatratzen (im Gegensatz zu Beton oder Gummimatten) oder eine höhere Sollwerterfüllung für die Nackenriegelhöhe bzw. ein höher angesetzter Seitenbügel



die Abliegedauern verkürzen. Im Zuge dieser Analyse fiel auf, dass kurze Abliegedauern teilweise mit einem hohen Anteil an ‚Anschlagen während des Abliegens‘ bzw. Abbrüchen der Abliegevorgänge einhergingen. Des Weiteren wurde ein Betrieb der einen Ausreißer darstellte, von der nachfolgenden Analyse ausgeschlossen.

Die letzte Analyse umfasst beeinträchtigtes Abliegeverhalten. Hierzu wurden der Anteil der Abliegevorgänge die mehr als 6,3 Sekunden dauerten, mit dem Anteil der abgebrochenen Abliegevorgänge und dem Anteil der Tiere, die zwar kürzer als 6,3 Sekunden für den Abliegevorgang gebraucht aber angeschlagen haben, addiert und durch alle beobachteten Abliegevorgänge dividiert. Das Modell für die ‚Prozent beeinträchtigter Abliegevorgänge‘, in das 13 Prädiktoren eingeflossen sind, hatte einen Erklärungswert von 41,3 % ( $F=4,45$ ;  $p=0,0157$ ). Danach steht ein längerer Seitenbügel ( $t=-2,31$ ;  $p=0,0322$ ) mit einem geringeren Anteil an beeinträchtigen Abliegevorgängen in Verbindung. Wenn auch nicht signifikant, so wurden mit jedem zusätzlichen Prozent Sollwerterfüllung der Boxenbreite ( $t=-1,76$ ;  $p=0,0937$ ) 2 % weniger beeinträchtigte Abliegevorgänge vorausgesagt. Sinkende Werte wurden auch mit dem Vorhandensein von Stroh oder Strohanteilen in der Einstreu ( $t=-1,96$ ;  $p=0,1076$ ) in Verbindung gebracht. Zwischen beeinträchtigtem Abliegeverhalten und der Zitzen- ( $r_p=0,073$ ,  $p=0,739$ ) bzw. Zitzenkuppenverschmutzung ( $r_p=0,141$ ,  $p=0,522$ ) konnte kein Zusammenhang beobachtet werden. Auch unter Berücksichtigung der Tiergrößen blieben große Teile der Varianz im Abliegeverhalten unerklärt. Möglicherweise sind es die komplexen Interaktionen innerhalb der Liegeboxencharakteristika im Zusammenspiel mit tierbezogenen Faktoren (Gesundheitszustand, Laktationsstadium, usw.), die klare Zusammenhänge vermissen lassen.

In dieser Studie wurden die Tiergrößen im Gegensatz zu vielen anderen Untersuchungen mit einbezogen, konnten aber nicht den entscheidenden Durchbruch bezüglich neuer Erkenntnisse zum Einfluss der Boxendimensionierung liefern. In Einklang mit anderen Studien kann abschließend festgehalten werden, dass Liegeboxenabmessungen auf Praxisbetrieben, im Hinblick auf die Tiergrößen, oftmals unzureichend sind. Damit einhergehend finden sich hohe Anteile an beeinträchtigtem Abliegeverhalten bei unbefriedigender Zitzenverschmutzung. Die Zusammenhänge zwischen Liegekomfort und Euterverschmutzung sind offenbar wesentlich komplexer als angenommen. Einzelfaktoren in diesem Geflecht zu identifizieren, die allgemein gültig und auf alle Betriebssituationen übertragbar sind, gestaltet sich äußerst schwierig.

Die Frage ob guter Liegekomfort und geringe Euterverschmutzung unvereinbar sind, kann insofern verneint werden, als Einflussfaktoren ermittelt wurden, die sich sowohl positiv auf die Zitzensauberkeit als auch auf den Liegekomfort auswirken. Dennoch

die bleiben die hohen Erwartungen die an Liegeboxen bezüglich der Prävention vor Verschmutzung gestellt werden weitgehend unerfüllt. Basierend auf den Ergebnissen dieser Studie können Tiefboxen und ein verbessertes Management bezüglich der Boxeneinstreu und -pflege empfohlen werden, um einen guten Liegekomfort bei akzeptabler Zitzenverschmutzung zu erreichen.

---

## 8. References

- Abramson, J.H., 2003. PAIRSetc. v. 1.17, Computer programs for epidemiologists. WINPEPI. Epidemiologic Perspectives and Innovations, [www.epi-perspectives.com/content/1/1/6](http://www.epi-perspectives.com/content/1/1/6). Accessed 08.07.2010
- Aland, A., Lidfors, L., Ekesbo, I., 2002. Diurnal distribution of dairy cow defecation and urination. *Appl. Anim. Behav. Sci.*, 43-54
- Arave, C.W., Walters, J.L., 1980. Factors affecting lying behavior and stall utilization of dairy cattle. *Appl. Anim. Eth.*, 369-376.
- Barkema, H.W., van der Ploeg, J.D., Schukken, Y.H., Lam, T.J.G.M., Benedictus, G., Brands, A., 1999. Management style and its association with bulk milk somatic cell count and incidence rate of clinical mastitis. *Journal of Dairy Science* 82, 1655-1663.
- Bartussek, H., Lenz, V., Würzel, H., Zucca, D., 2008. *Rinderstallbau*. Leopold Stocker Verlag, Graz.
- Bergmann, J., Heuwieser, W., 2000. Kuhkomfort. Optimale Leistungen nur durch optimale Bedingungen. 2. Teil: Liegeboxengestaltung. *Milchpraxis* 38, 68-71.
- Bergmann, J., Kluth, J., Heuwieser, W., 2000. Kuhkomfort. Optimale Leistungen nur durch optimale Bedingungen. Teil 1: Verhaltensbiologie und Stallgestaltung. *Milchpraxis* 38, 14-17.
- Bernardi, F., Fregonesi, J.A., Winckler, C., Veira, D.M., von Keyserlingk, M.A.G., Weary, D.M., 2009. The stall-design paradox: Neck rails increase lameness but improve udder and stall hygiene. *J. Dairy Sci.* 92, 3074-3080.
- Blom, J.Y., Konggaard, S.P., Larsson, J.G., Nielsen, K., Northeved, A., Solfeld, P., 1984. Electronic Recording of Pressure Exerted by Cows Against Structures in Free-Stall Housing. *Appl. Anim. Behav. Sci.* 13, 41-46.
- BMELV, 2009. Anteil der Verkaufserlöse der Landwirtschaft an den Verbraucherausgaben für Nahrungsmittel inländischer Herkunft in Deutschland. <http://www.bmelv-statistik.de/de/statistischer-monatsbericht/a-landwirtschaft/>, Accessed 14.03.2011
- Bock, C., 1990. Zur Beurteilung tiergerechter Laufställe für Milchvieh. KTBL, Darmstadt
- Bockisch, F.-J., 1991. Quantifizierung von Interaktionen zwischen Milchkühen und deren Haltungsumwelt als Grundlage zur Verbesserung von Stallsystemen und ihrer ökonomischen Bewertung. Ferber'sche Universitätsbuchhandlung, Gießen

- Bowell, V.A., Rennie, L.J., Tierney, G., Lawrence, A.B., Haskell, M.J., 2003. Relationships between building design, management system and dairy cow welfare. *Anim. Welfare* 12, 547-552.
- Brade, W., 2005. Longevity and reasons for culling of milk yield controlled Holstein cows: Consequences for breeding? *Praktische Tierarzt* 86, 658-667
- Brandes, C., 2000. Warum so viele Liegeboxen versagen. *top agrar*, Münster, R12-R16.
- Byrt, T., Bishop, J., Carlin, J.B., 1993. Bias, prevalence and kappa. *J Clin. Epidemiol.* 46, 423-429.
- Calamari, L., Calegari, F., Stefanini, L., 2009. Effect of different free stall surfaces on behavioural, productive and metabolic parameters in dairy cows. *Appl. Anim. Behav. Sci.* 120, 9-17.
- Capdeville, J., Veissier, I., 2001. A method of assessing welfare in loose housed dairy cows at farm level, focusing on animal observations. *Acta Agric. Scand. Sect. A-Anim. Sci.*, 62-68.
- Ceballos, A., Sanderson, D., Rushen, J., Weary, D.M., 2004. Improving stall design: Use of 3-D kinematics to measure space use by dairy cows when lying down. *J Dairy Sci.* 87, 2050.
- Cermak, J., 1988. Cow comfort and lameness - Design of cubicles. *The Bovine Practitioner* 23, 79-83.
- Chaplin, S.J., Munksgaard, L., 2001. Evaluation of a simple method for assessment of rising behaviour in tethered dairy cows. *Anim. Sci.* 72, 191-197.
- Chaplin, S.J., Tierney, G., Stockwell, C., Logue, D.N., Kelly, M., 2000. An evaluation of mattresses and mats in two dairy units. *Appl. Anim. Behav. Sci.* 66, 263-272.
- Christiansson, A., Bertilsson, J., Svensson, B., 1999. *Bacillus cereus* spores in raw milk: Factors affecting the contamination of milk during the grazing period. *J. Dairy Sci.* 82, 305-314.
- CIGR, 1994. The Design of Dairy Cow Housing. In: Section II Working Group No.14 Cattle Housing (Ed.), ADAS Bridgets Dairy Research Centre, Farm Buildings Research Team, 3-19.
- Cook, N.B., Bennett, T.B., Nordlund, K.V., 2005. Monitoring indices of cow comfort in free-stall-housed dairy herds. *J. Dairy. Sci.* 88, 3876-3885.
- Cook, N.B., Reinemann, D., 2007. A Tool Box for Assessing Cow, Udder and Teat Hygiene. Annual NMC Meeting (46th), San Antonio, TX, January 21-24, Proceedings, 31-43
- Cooper, M.D., Arney, D.R., Phillips, C.J.C., 2008. The effect of temporary deprivation of lying and feeding on the behaviour and production of lactating dairy cows. *Animal* 2, 275-283.

- Dawkins, M.S., 2004. Using behaviour to assess animal welfare. *Anim. Welfare* 13, 3-7.
- Deutscher Holstein Verband e.V., 2007. Zahlen und Fakten - 2009. [http://www.holstein-dhv.de/zahlen\\_und\\_fakten.html](http://www.holstein-dhv.de/zahlen_und_fakten.html), Accessed 22.01.2011
- Dippel, S., Dolezal, M., Brenninkmeyer, C., Brinkmann, J., March, S., Knierim, U., Winckler, C., 2009a. Risk factors for lameness in cubicle housed Austrian Simmental dairy cows. *Prev. Vet. Med.* 90, 102-112.
- Dippel, S., Dolezal, M., Brenninkmeyer, C., Brinkmann, J., March, S., Knierim, U., Winckler, C., 2009b. Risk factors for lameness in freestall-housed dairy cows across two breeds, farming systems, and countries. *J. Dairy Sci.* 92, 5476-5486.
- Drissler, M., Gaworski, M., Tucker, C.B., Weary, D.M., 2005. Freestall maintenance: Effects on lying behavior of dairy cattle. *J. Dairy Sci.* 88, 2381-2387.
- EFSA, 2009. Effects of farming systems on dairy cow welfare and disease. Report of the Panel on Animal Health and Welfare . *The EFSA Journal* 1143, 1-284.
- Eurobarometer, 2007. Attitudes of EU citizens towards Animal Welfare. European Commission, Brussels.
- Faull, W.B., Hughes, J.W., Clarkson, M.J., Downham, D.Y., Manson, F.J., Merritt, J.B., Murray, R.D., Russell, W.B., Sutherst, J.E., Ward, W.R., 1996. Epidemiology of lameness in dairy cattle: The influence of cubicles and indoor and outdoor walking surfaces. *Vet. Rec.* 139, 130-136.
- FAWC, 2001. Interim report on the animal welfare implications of farm assurance schemes. Farm Animal Welfare Council, London.
- Fetrow, J., Mann, D., Butcher, K., Mcdaniel, B., 1991. Production Losses from Mastitis - Carry-Over from the Previous Lactation. *J. Dairy Sci.* 74, 833-839.
- Fleiss, J.L., Levin, B., Paik, M.C., 2003. The measurement of interrater agreement. In: *Statistical Methods for Rates and Proportions*, John Wiles and Sons, Hoboken, New Jersey, 598-626.
- Fournier, A., 2003. Are your cows obtaining enough vitamin 'R' [rest]? *Producteur de Lait Quebecois*, 18-19.
- Fraser, A.F., Broom, D.M., 1990. *Farm animal behaviour and welfare*. Baillière Tindall, London.
- Fregonesi, J.A., Leaver, J.D., 2001. Behaviour, performance and health indicators of welfare for dairy cows housed in strawyard or cubicle systems. *Livestock Prod. Sci.* 68, 205-216.
- Fregonesi, J.A., Tucker, C.B., Weary, D.M., 2007a. Overstocking reduces lying time in dairy cows. *J. Dairy Sci.* 90, 3349-3354.

- 
- Fregonesi, J.A., Veira, D.M., von Keyserlingk, M.A.G., Weary, D.M., 2007b. Effects of bedding quality on lying behaviour of dairy cows. *J. Dairy Sci.* 90 (12), 5468-5472.
- Fregonesi, J.A., von Keyserlingk, M.A.G., Tucker, C.B., Veira, D.M., Weary, D.M., 2009. Neck-rail position in the free stall affects standing behavior and udder and stall cleanliness. *J. Dairy Sci.* 92, 1979-1985.
- Fulwider, W.K., Grandin, T., Garrick, D.J., Engle, T.E., Lamm, W.D., Dalsted, N.L., Rollin, B.E., 2007. Influence of free-stall base on tarsal joint lesions and hygiene in dairy cows. *J. Dairy Sci.* 90, 3559-3566.
- Haley, D.B., de Passillé, A.M., Rushen, J., 2001. Assessing cow comfort: effects of two floor types and two tie stall designs on the behaviour of lactating dairy cows. *Appl. Anim. Behav. Sci.* 71, 105-117.
- Haley, D.B., Rushen, J., de Passillé, A.M., 2000. Behavioural indicators of cow comfort: activity and resting behaviour of dairy cows in two types of housing. *Can. J. Anim. Sci.* 80, 257-263.
- Harrison, R., 1964. *Animal Machines – The New Factory Industry*. Vincent Stuart Ltd., London.
- Herlin, A.H., 1997. Comparison of lying area surfaces for dairy cows by preference, hygiene and lying down behaviour. *Swed. J. Agr. Res.* 27, 189-196.
- Hogan, J.S., Smith, K.L., 1997. Bacteria counts in sawdust bedding. *J. Dairy Sci.* 80, 1600-1605.
- Hörning, B., 2003a. Attempts to integrate different parameters into an overall picture of animal welfare using investigations in dairy loose houses as an example. *Anim. Welfare* 12, 557-563.
- Hörning, B., 2003b. *Nutztierethologische Untersuchungen zur Liegeplatzqualität in Milchviehlaufstallsystemen unter besonderer Berücksichtigung eines epidemiologischen Ansatzes*. Thesis, Kassel, Germany
- Hörning, B., Simantke, C., Aubel, E., Andersson, R., 2004. Ökologische Milch- und Rindfleischproduktion: Struktur, Entwicklung, Probleme, politischer Handlungsbedarf. In: *Geschäftsstelle Bundesprogramm Ökologischer Landbau in der Bundesanstalt für Landwirtschaft und Ernährung (BLE)*, Bonn, 1-226.
- Kämmer, P., 1981. *Untersuchungen zur Tiergerechtheit und ihrer Bestimmung bei Boxenlaufstallhaltung von Milchkühen in der Schweiz*. PhD Thesis. Bern, Switzerland
- Kämmer, P., Schnitzer, U., 1975. *Die Stallbeurteilung am Beispiel des Ausruhverhaltens von Milchkühen*. KTBL, Darmstadt
- Keil, N.M., Gisiger, E., Stauffacher, M., 2003. *Evaluation von Liegeboxenabmessungen für Rindvieh aufgrund des Liegeverhaltens unterschiedlich großer Milchkühe*. KTBL, Darmstadt

- Kjoestad, H.P., Myren, H.J., 2001. Cubicle refusal in Norwegian dairy herds. *Acta Vet. Scand.* 42, 181-187.
- Knierim, U., Winckler, C., 2009. On-farm welfare assessment in cattle: validity, reliability and feasibility issues and future perspectives with special regard to the Welfare Quality® approach. *Anim. Welfare* 18, 451-458.
- Krohn, C.C., Munksgaard, L., 1993. Behaviour of dairy cows kept in extensive (loose housing/pasture) or intensive (tie stall) environments II. Lying and lying-down behaviour. *Appl. Anim. Behav. Sci.* 37, 1-16.
- Krohn, C.C., Munksgaard, L., Jonasen, B., 1992. Behaviour of dairy cows kept in extensive (loose housing/pasture) or intensive (tie stall) environments. I. Experimental procedure, facilities, time budgets- diurnal and seasonal conditions. *Appl. Anim. Behav. Sci.* 34, 37-47.
- Lidfors, L., 1989. The use of getting up and lying down movements in the evaluation of cattle environments. *Veterinary Research Communications* 13, 307-324.
- Lombard, J.E., Tucker, C.B., von Keyserlingk, M.A.G., Koprak, C.A., Weary, D.M., 2010. Association between cow hygiene, hock injuries, and free stall usage on US dairy farms. *J. Dairy Sci.* 93, 4668-4676.
- Magnusson, M., Herlin, A.H., Ventorp, M., 2008. Short communication: Effect of alley floor cleanliness on free-stall and udder hygiene. *J. Dairy Sci.* 91, 3927-3930.
- Martin, P., Bateson, P., 2007. *Measuring behaviour*. Cambridge University Press, Cambridge.
- Martiskainen, P., Koistinen, T., Mononen, J., 2007. Cubicle dimensions affect resting-related behaviour, injuries and dirtiness of loose-housed dairy cows. Animal health, animal welfare and biosecurity. *Proceedings of 13th International Congress in Animal Hygiene*. Volume 1, 175-180.
- Miller, K., Woodgush, D.G.M., 1991. Some Effects of Housing on the Social-Behavior of Dairy-Cows. *Anim. Prod.* 53, 271-278.
- Munksgaard, L., Jensen, M.B., Pedersen, L.J., Hansen, S.W., Matthews, L., 2005. Quantifying behavioural priorities - effects of time constraints on behaviour of dairy cows, *Bos taurus*. *Appl. Anim. Behav. Sci.* 92, 3-14.
- Munksgaard, L., Simonsen, H.B., 1996. Behavioral and pituitary adrenal-axis response of dairy cows to social isolation and deprivation of lying down. *J. Anim. Sci.* 74, 769-778.
- Nelson, A.J., 1996. On-farm nutrition diagnostics. *Proceedings of the 29<sup>th</sup> Convention AABP*, 76-85.
- Nishida, T., Hosoda, K., Matsuyama, H., Ishida, M., 2004. Effect of lying behavior on uterine blood flow in cows during the third trimester of gestation. *J. Dairy Sci.* 87, 2388-2392.

- Norring, M., Manninen, E., de Passillé, A.M., Rushen, J., Munksgaard, L., Saloniemi, H., 2008. Effects of sand and straw bedding on the lying behavior, cleanliness, and hoof and hock injuries of dairy cows. *J. Dairy Sci.* 91, 570-576.
- O'Connell, J.M., Giller, P.S., Meaney, W.J., 1992. Factors affecting cubicle utilisation by dairy cattle using stall frame and bedding manipulation experiments. *Appl. Anim. Behav. Sci.* 35, 11-21.
- O'Driscoll, K., Boyle, L., Hanlon, A., 2009. The effect of breed and housing system in dairy cow feeding and lying behaviour. *Appl. Anim. Behav. Sci.* 116, 156-162.
- Osteras, O., Lund, A., 1988. Epidemiological Analyses of the Associations between Bovine Udder Health and Housing. *Prev. Vet. Med.* 6, 79-90.
- Overton, M.W., Sisco, W.M., Temple, G.D., Moore, D.A., 2002. Using time-lapse video photography to assess dairy cattle lying behavior in free-stall barn. *J. Dairy Sci.* 85, 2407-2413.
- Phillips, C., 2002. *Cattle behaviour and welfare*. Blackwell Science, Oxford.
- Phillips, C.J.C., Schofield, S.A., 1994. The effect of cubicle and straw yard housing on the behaviour, production and hoof health of dairy cows. *Anim. Welfare* 3, 37-44.
- Potterton, S.L., Green, M.J., Harris, J., Millar, K.M., Whay, H.R., Huxley, J.N., 2011. Risk factors associated with hair loss, ulceration, and swelling at the hock in freestall-housed UK dairy herds. *J. Dairy Sci.* 94, 2952-2963.
- Reich, L.J., Weary, D.M., Veira, D.M., von Keyserlingk, M.A.G., 2010. Effects of sawdust bedding dry matter on lying behavior of dairy cows: A dose-dependent response. *J. Dairy Sci.* 93, 1561-1565.
- Reneau, J.K., Seykora, A.J., Heins, B.J., Endres, M.I., Farnsworth, R.J., Bey, F., 2005. Association between hygiene scores and somatic cell scores in dairy cattle. *J. Am. Vet. Med. Ass.* 227, 1297-1301.
- Rousing, T., Bonde, M., Sørensen, J.T., 2001. Aggregating welfare indicators into an operational welfare assessment system: A bottom-up approach. *Acta Agric. Scand. Sect. A Anim. Sci.* 30, 57.
- Ruckebusch, Y., 1972. The relevance of drowsiness in the circadian cycle of farm animals. *Anim. Behav.* 20, 637-643.
- Rulquin, H., Caudal, J.P., 1992. Effects of lying or standing on mammary blood-flow and heart-rate of dairy-cows. *Annales de Zootechnie* 41, 101.
- Ruud, L.E., Boe, K.E., Osteras, O., 2010. Risk factors for dirty dairy cows in Norwegian freestall systems. *J. Dairy Sci.* 93, 5216-5224.
- Schreiner, D.A., Ruegg, P.L., 2003. Relationship between udder and leg hygiene scores and subclinical mastitis. *J. Dairy Sci.* 86, 3460-3465.



- Schukken, Y.H., Grommers, F.J., van de Geer, D., Erb, H.N., Brand, A., 1990. Risk factors for clinical mastitis in herds with a low bulk milk somatic cell count. 1. Data and risk factors for all cases. *J. Dairy Sci.* 73, 3463-3471.
- Shim, E.H., Shanks, R.D., Morin, D.E., 2004. Milk loss and treatment costs associated with two treatment protocols for clinical mastitis in dairy cows. *J. Dairy Sci.* 87, 2702-2708.
- Shuji, Y., Ito, M., 1999. Individual characteristics of rumination in dairy cows. In: *Bulletin of the Faculty of Agriculture, Niigata University*, 139-146.
- Singh, S.S., Ward, W.R., Hughes, J.W., Lautenbach, K., Murray, R.D., 1994. Behaviour of dairy cows in a straw yard in relation to lameness. *Vet. Rec.* 135, 251-253.
- Spoolder, H.A.M., De Rosa, G., Hörning, B., Waiblinger, S., Wemelsfelder, F., 2003. Integrating parameters to assess on-farm welfare. *Anim. Welfare* 12, 529-534.
- Statistisches Bundesamt, 2011. Wer produziert unsere Nahrungsmittel? Aktuelle Ergebnisse der Landwirtschaftszählung 2010. [www.destatis.de](http://www.destatis.de). Accessed 12.04.2011
- Sunderland, E., 2002. A study of the association between cattle cubicle design and cow cleanliness. *Cattle Practice* 10 (2), 147-155.
- Troxler, J., 1987. Tiergerechte Milchviehhaltung - Normen der Aufstallung. *Swiss Vet.* 19-23.
- Tucker, C.B., Weary, D.M., 2004. Bedding on geotextile mattresses: How much is needed to improve cow comfort? *J. Dairy Sci.* 87, 2889-2895.
- Tucker, C.B., Weary, D.M., Fraser, D., 2003. Effects of three types of free-stall surfaces on preferences and stall usage by dairy cows. *J. Dairy Sci.* 86, 521-529.
- Tucker, C.B., Weary, D.M., Fraser, D., 2004. Free-stall dimensions: Effects on preference and stall usage. *J. Dairy Sci.* 87, 1208-1216.
- Tucker, C.B., Weary, D.M., Fraser, D., 2005. Influence of neck-rail placement on free-stall preference, use, and cleanliness. *J. Dairy Sci.* 88, 2730-2737.
- Tucker, C.B., Zdanowicz, G., Weary, D.M., 2006. Brisket boards reduce freestall use. *J. Dairy Sci.* 89, 2603-2607.
- Veissier, I., Capdeville, J., Delval, E., 2004. Cubicle housing systems for cattle: Comfort of dairy cows depends on cubicle adjustment. *J. Anim. Sci.* 82, 3321-3337.
- Wagner-Storch, A.M., Palmer, R.W., Kammel, D.W., 2003. Factors affecting stall use for different freestall bases. *J. Dairy Sci.* 86, 2253-2266.

- Weary, D.M., von Keyserlingk, M.A.G., Edmond, A.P., 2008. What is affecting housing design and other management practices - economics or animal welfare? Tri-State Dairy Nutrition Conference, 23-28.
- Wechsler, B., Schaub, J., Friedli, K., Hauser, R., 2000. Behaviour and leg injuries in dairy cows kept in cubicle systems with straw bedding or soft lying mats. *Appl. Anim. Behav. Sci.* 69, 189-197.
- Welfare Quality® Consortium, 2009. Welfare Quality® assessment protocol for cattle. Welfare Quality® Consortium, Lelystad, Netherlands.
- Whay, H.R., Main, D.C.J., Green, L.E., Webster, A.J.F., 2003. Assessment of the welfare of dairy cattle using animal-based measurements: direct observations and investigation of farm records. *Vet. Rec.* 153, 197-202.
- Whistance, L.K., Arney, D.R., Sinclair, L.A., Phillips, C.J.C., 2007. Defaecation behaviour of dairy cows housed in straw yards or cubicle systems. *Appl. Anim. Behav. Sci.* 105, 14-25.
- Wierenga, H.K., Hopster, H., 1982. Die Reaktion von Milchvieh auf die Einschränkung von Liegeplätzen im Laufstall. *KTBL*, Darmstadt, 46-60.
- Wierenga, H.K., Hopster, H., 1990a. The Significance of Cubicles for the Behaviour of Dairy Cows. *Appl. Anim. Behav. Sci.* 26, 309-337.
- Wierenga, H.K., Hopster, H., 1990b. The significance of cubicles for the behaviour of dairy cows. *Appl. Anim. Behav. Sci.* 26, 309-337.
- Winckler, C., Buehnemann, A., Seidel, K., 2002. Social behaviour of commercial dairy herds as a parameter for on-farm welfare assessment. Proceedings of the 36rd International Congress of the International Society for Applied Ethology. 6.- 10. August 2002, Wageningen, The Netherlands, 86.
- Winckler, C., Capdeville, J., Gebresenbet, G., Horning, B., Roiha, U., Tosi, M., Waiblinger, S., 2003. Selection of parameters for on-farm welfare-assessment protocols in cattle and buffalo. *Anim. Welfare* 12, 619-624.
- Zdanowicz, M., Shelford, J.A., Tucker, C.B., Weary, D.M., von Keyserlingk, M.A.G., 2004. Bacterial populations on teat ends of dairy cows housed in free stalls and bedded with either sand or sawdust. *Journal of Dairy Science* 87, 1694-1701.

**Parts of this thesis have previously been published:**

Plesch, G., Broerkens, N., Laister, S., Knierim, U., Winckler, C., 2009. Evaluation of different measures of rising and lying down difficulties for the on-farm welfare assessment of dairy cows. In: Abstracts of the Joint East Central and West Central Europe ISAE regional meeting. 25.-26.09., Vienna, Austria, p. 10.

Plesch, G., Broerkens, N., Laister, S., Winckler, C., Knierim, U., 2010. Reliability and feasibility of selected measures concerning resting behaviour for the on-farm welfare assessment in dairy cows. *Appl. Anim. Behav. Sci.* 126, 19-26.

Plesch, G., Knierim, U., 2010. Lying down duration in German Holstein dairy cows housed in cubicles in relation to body size and cubicle characteristics. In: Wageningen Academic Publishers, Swedish University of Agricultural Sciences, Uppsala, Sweden, p. 70.

Plesch, G., 2009. Guter Liegekomfort und akzeptable Euterverschmutzung – ein unlösbares Problem? 2. Düsser Milchviehforum - Neues aus Beratung, Industrie und Wissenschaft. Landwirtschaftszentrum Haus Düsse, 16.-17.02. Bad Sassendorf, Germany.

---

## Acknowledgements

I am grateful to Prof. Dr. Ute Knierim, for giving me the opportunity to work on the animals that I adore, for her helpful suggestions, all the efforts she made and all the time she spent for discussions.

I would like to thank Dr. Sabine Dippel for spontaneously agreeing to officiate as examiner.

Within the Welfare Quality® project I owe my gratitude to Nina Brörkens, who accurately prepared the changeover before she left and Karin Weigel who assisted with data collection in Austria. Thanks to Bas Engels for statistical advice. Furthermore I'd like to thank my co-authors Christoph Winckler and Simone Laister for their kind co-operation.

I would like to thank all the people who helped me with farm recruitment. I am especially grateful to Andreas Pelzer and Katharina Dahlhoff (LWK NRW) and Prof. Dr. Wilfried Brade, Dr. Jörg Küster, Dr. Georg Teepker and Dr. Jakob Groenewold of the LWK Niedersachsen, for providing me with addresses of farmers.

Thanks to Anja Zimmermann, Maja Günther and especially Tobias Gorniak, who assisted with data collection and accompanied me through snow and iciness during farm visit periods.

I am indebted to the farmers who participated in this study for their attendance, interest and hospitality.

Thanks to all cows, for bringing joy to my life!

I would like to thank the colleagues and friends that supported me during my time in Witzenhausen.

Last but not least I am deeply indebted to my family and Tobias for emotional support, bearing up and accepting that I am obsessed with cows. 😊



„Hiermit versichere ich, dass ich die vorliegende Dissertation selbständig und ohne unerlaubte Hilfe angefertigt und andere als die in der Dissertation angegebenen Hilfsmittel nicht benutzt habe. Alle Stellen, die wörtlich oder sinngemäß aus veröffentlichten oder unveröffentlichten Schriften entnommen sind, habe ich als solche kenntlich gemacht. Kein Teil dieser Arbeit ist in einem anderen Promotions- oder Habilitationsverfahren verwendet worden.“

Witzenhausen, den 19.07.2011

Gudrun Plesch