

# **Photovoltaic Hybrid Systems for Rural Electrification in the Mekong Countries**

A thesis submitted in partial fulfilment for the degree of Doctor of Engineering (Dr.-Ing) in the specialized area of Renewable Energy Technology at the Faculty of Electrical Engineering/Information Technology, University of Kassel.

By

**M.Sc. Nipon Ketjoy**

Kassel: Aug, 2005

## **Supervisors:**

1. Prof. Dr.-Ing. Jürgen Schmid
2. Prof. Dr. Wattanapong Rakwichian

## **ERKLÄRUNG**

Hiermit versichere ich, dass ich die vorliegende Dissertation selbständig und ohne unerlaubte Hilfe angefertigt und andere als die in der Dissertation angegebenen Hilfsmittel nicht benutzt habe. Alle Stellen, die wörtlich oder sinngemäß aus veröffentlichten oder unveröffentlichten Schriften entnommen sind, habe ich als solche kenntlich gemacht. Kein Teil dieser Arbeit ist in einem anderen Promotions- oder Habilitationsverfahren verwendet worden.

Kassel, 24.08.2005

## **ABSTRACT**

In rural areas of the Mekong Countries, the problem of electricity supplying rural communities is particularly alarming. Supplying power to these areas requires facilities that are not economically viable. However, government programs are under way to provide this product that is vital to community well being. A nation priority of Mekong Countries is to provide electrical power to people in rural areas, within normal budgetary constraints. Electricity must be introduced into rural areas in such a way that maximize the technical, economic and social benefit. Another consideration is the source of electrical generation and the effects on the natural environment. The main research purpose is to implement field tests, monitoring and evaluation of the PV-Diesel Hybrid System (PVHS) at the Energy Park of School of Renewable Energy Technology (SERT) in order to test the PVSH working under the meteorological conditions of the Mekong Countries and to develop a software simulation called RES, which studies the technical and economic performance of rural electrification options. This software must be easy to use and understand for the energy planner on rural electrification projects, to evaluate the technical and economic performance of the PVHS based on the renewable energy potential for rural electrification of the Mekong Country by using RES. Finally, this project aims to give guidance for the possible use of PVHS application in this region, particularly in regard to its technical and economic sustainability. PVHS should be promoted according to the principles of proper design and adequate follow up with maintenance, so that the number of satisfied users will be achieved. PVHS is not the only possible technology for rural electrification, but for the Mekong Countries it is one of the most proper choices. Other renewable energy options such as wind, biomass and hydro power need to be studied in future.

## ZUSAMMENFASSUNG

In ländlichen Gebieten der Mekong-Länder stellt die Elektrifizierung abgelegener Dörfer und Gemeinden ein besonderes Problem dar. Die Energieversorgung dieser Gegenden erfordert Versorgungseinheiten, die häufig unter ökonomischen Gesichtspunkten nicht sinnvoll realisierbar sind. Allerdings wurden staatliche Förderungsprogramme initiiert, die den Aufbau von Energieversorgungsanlagen ermöglichen, die für den Wohlstand einer Region eine entscheidende Rolle spielen. Eines der Hauptziele der Mekong-Länder ist es, die ländliche Elektrifizierung im Rahmen normaler finanzieller Möglichkeiten durchzuführen. Die Einführung der Energieversorgung in den betreffenden Regionen muss in einer Weise durchgeführt werden, die einen maximalen Nutzen für die Gebiete in technischer, ökonomischer und sozialer Hinsicht bedeutet. Weiterhin ist die Wahl der Energiequelle und deren Einfluss auf die Umwelt zu bedenken. Der Schwerpunkt der vorliegenden Forschungsarbeit liegt in der Implementierung von Feldtests und der Überwachung und Auswertung des PV-Diesel-Hybridsystems (PVHS) im Energy Park der School of Renewable Energy Technology (SERT), um die Funktion des PVHS unter den klimatischen Bedingungen eines Mekong-Landes zu testen. Des Weiteren wurde eine Simulationssoftware entwickelt, mit der Energieversorgungssysteme unter Nutzung erneuerbarer Energiequellen (RES) auf ihre ökonomische Eignung zur Elektrifizierung ländlicher Gebiete untersucht werden können. Diese Software muss einfach zu handhaben und für den Anlagenplaner leicht verständlich sein. Das PVHS wird im Hinblick auf die technische und ökonomische Leistungsfähigkeit unter dem Dargebot der Erneuerbaren Energiequellen in einem Mekong Land untersucht. Im Anschluss wird eine Anleitung für mögliche Anwendungen von PVHS in den genannten Regionen gegeben, insbesondere im Hinblick auf ihre technische und ökonomische Nachhaltigkeit. PVHS sollten vorangetrieben werden, indem sie angemessen ausgelegt und in der Folge in ausreichendem Maße für Wartung und Reparatur gesorgt ist. Nur dann können die Nutzer auf Dauer zufrieden gestellt werden. PVHS sind nicht die einzige Möglichkeit zur Elektrifizierung abgelegener Gebiete, aber für die Mekong-Länder stellen sie eine gute Wahl dar. Andere Optionen zur Nutzung Erneuerbarer Energien wie Wind, Biomasse und Wasserkraft sollten Gegenstand zukünftiger Forschung sein.

## **ACKNOWLEDGEMENTS**

I am very grateful to my supervisor Prof. Dr. -Ing. Jürgen Schmid for their guidance and encouragement of my research efforts. In addition, I would like to thank Prof. Dr. Wattanapong Rakwichian for his help with during this study.

I am grateful to PD Dr. -Ing. Siegfried Heier from the Department of Electrical power supply systems that I also took an exciting course in Use of the Wind Energy.

I would like to thank Dipl. -Ing. Franz Kininger from the Department of Efficient Energy Conversion for all great support during me study in the university. My very special thanks go to Ms. Claudia Erdt who assisted me on very many occasions. Thank to Dr. -Ing. Ingo Stadler and all Department staff for any kind support.

I would like to thank Dipl. -Ing. Jiratkwinn Rakwichian, Dipl. -Ing. Phongsuk Ampha, Mr. Arnusorn Saenparnjak, Dr. -Ing. Boonyang Plangklang, Mr. Amnoiy Ruengwaree and other Thai also German friends Dipl. -Ing. Thorsten Bülo, especially to Mr. Wolf Ruediger Engelke for providing great support to me during studying in Germany.

Thanks to the Energy Conservation Promotion Fund (ENCON Fund), Energy Policy and Planning Office (EPPO), Ministry of Energy, Thailand (Fiscal Year 2003 budget) and Faculty of Science, Naresuan University for the financial support during my study. In addition, the thesis work was sponsored by National Research Council of Thailand (NRCT), a cooperated research by School of Renewable Energy Technology, Naresuan University, Thailand and a Department of Efficient Energy Conversion, University of Kassel, Germany. And thanks to the European Commission for give a change to joint in project Mini-Grid Kit NNE5-1999-00487 as I took a part of this project to my research.

Thank to the Council on Renewable Energy in the Mekong Region (CORE) secretary office for provide me the information of Mekong Region.

Finally, I would like to thank my family and parents, for their support during this time.

## TABLE OF CONTENTS

<b>1</b>	<b>INTRODUCTION</b> .....	1
1.1	Motivation .....	1
1.2	Hybrid system technology.....	2
1.3	Software simulations.....	3
1.4	Objectives of study .....	3
1.5	Outline of the thesis .....	5
<b>2</b>	<b>RURAL ELECTRIFICATION IN THE MEKONG COUNTRY</b> .....	7
2.1	Introduction to Mekong Country.....	7
2.1.1	Geography and demography .....	7
2.1.2	Climate condition .....	10
2.1.3	Economic situation.....	11
2.2	Rural electrification situations .....	14
2.2.1	Rural electricity needs and development.....	14
2.2.2	General characteristic of rural energy use .....	14
2.2.3	Rural electrification .....	16
2.3	Rural electrification policy in selected Mekong Countries .....	18
<b>3</b>	<b>RENEWABLE HYBRID POWER SYSTEM</b> .....	23
3.1	Renewable energy potential in Mekong Country .....	23
3.1.1	Hydro energy .....	23
3.1.2	Biomass energy .....	25
3.1.3	Wind power.....	27
3.1.4	Solar energy .....	29
3.2	PV hybrid system technology category.....	30
3.3	Prototype of hybrid system for Mekong Country.....	33
3.3.1	Modular Systems Technology (MST).....	33
3.3.2	Classes of power units.....	35
3.3.3	The prototype system at SERT .....	35
3.4	Testing and monitoring of the prototype .....	36
3.4.1	Test method.....	36

3.4.2	Data monitoring system .....	39
3.4.3	Data analysis .....	41
3.4.4	Technical performance evaluation results .....	43
<b>4</b>	<b>RURAL ELECTRIFICATION SOFTWARE.....</b>	<b>45</b>
4.1	Software concept .....	45
4.2	Model and algorithm .....	46
4.2.1	Solar radiation model.....	47
4.2.2	System component model .....	50
4.2.3	Economical model .....	57
4.3	Software testing .....	61
4.3.1	Validation of RES PVHS model compared with PVHS monitored .....	61
4.3.2	Validation of RES PVS model compared with PVS monitored .....	63
4.4	Summary .....	66
<b>5</b>	<b>CASE STUDY OF RURAL ELECTRIFICATION IN MEKONG COUNTRIES.....</b>	<b>67</b>
5.1	Introduction .....	67
5.2	Case of Ban Pang Praratchatang, Thailand .....	67
5.2.1	Description of Ban Pang Praratchatan .....	67
5.2.2	Input of RES .....	71
5.2.3	System performance results of PVHS at Ban Pang Praratchatan.....	72
5.2.4	Economics performance results of PVHS at Ban Pang Praratchatan.....	75
5.3	Case of Samaki, Cambodia .....	76
5.3.1	Description of Samaki.....	76
5.3.2	Input of RES .....	78
5.3.3	System performance results of PVHS at Samaki.....	78
5.3.4	Economics performance results of PVHS at Samaki.....	81
5.4	Case of Thapene, Lao PDR.....	82
5.4.1	Description of Thapene.....	82
5.4.2	Input of RES .....	85
5.4.3	System performance results of PVHS at BTP .....	85
5.4.4	Economics performance results of PVHS at BTP .....	88
5.5	Summary and outlook.....	89

<b>6</b>	<b>CONCLUSIONS AND RECOMMENDATIONS</b> .....	91
6.1	Outlook and future work.....	92
<b>7</b>	<b>REFERENCES</b> .....	95
<b>8</b>	<b>APPENDICES</b> .....	101
8.1	Appendix A: The hybrid system prototype drawing.....	101
8.2	Appendix B: The algorithms and user interface of RES.....	111



## TABLE OF FIGURES

<b>Figure 2-1:</b> Map of Mekong Countries .....	8
<b>Figure 2-2:</b> Mekong Countries population projection .....	9
<b>Figure 2-3:</b> Urban population projection.....	9
<b>Figure 2-4:</b> Solar radiation on horizontal surface of Thailand.....	10
<b>Figure 2-5:</b> Solar radiation on horizontal surface of Cambodia.....	11
<b>Figure 2-6:</b> The average solar radiation in typical region of Vietnam .....	11
<b>Figure 2-7:</b> Selected Mekong Country Gross Nation Product during 1997-2005 .....	12
<b>Figure 2-8:</b> Combinations of rural energy source in use in rural Laos.....	16
<b>Figure 2-9:</b> Rural energy in Pursat province, Cambodia .....	16
<b>Figure 3-1:</b> Series PV-diesel generator hybrid system.....	31
<b>Figure 3-2:</b> Switched PV-diesel generator hybrid system .....	32
<b>Figure 3-3:</b> Parallel PV-diesel generator hybrid system.....	33
<b>Figure 3-4:</b> Single and three phase AC-couple modular expandable hybrid.....	34
<b>Figure 3-5:</b> Hybrid system prototype at SERT .....	36
<b>Figure 3-6:</b> PVHS performance testing procedure with different loads profile .....	37
<b>Figure 3-7:</b> Load profile of small villages in northern of Thailand.....	37
<b>Figure 3-8:</b> Load profile of a single village in Chiangria, Thailand.....	38
<b>Figure 3-9:</b> Load profile of a Ban Pang Praratchatan village, Thailand.....	38
<b>Figure 3-10:</b> Load profile of a single household in Thailand .....	39
<b>Figure 3-11:</b> Hourly of load in Luo Buo Tai Zi, Xinjiang, China .....	39
<b>Figure 3-12:</b> Data monitoring system.....	40
<b>Figure 3-13:</b> Correlation of energy consumption and energy produced by genset... 43	
<b>Figure 3-14:</b> Balance of energy of the PVHS at SERT .....	44
<b>Figure 4-1:</b> Structure of the RES.....	46
<b>Figure 4-2:</b> Comparison of titled solar radiation calculated by RES and monitored . 62	
<b>Figure 4-3:</b> Comparison of PV energy production calculated and monitored.....	63
<b>Figure 4-4:</b> Comparison of genset energy production calculated and monitored.....	63
<b>Figure 4-5:</b> PV system at Chiangria Province, Thailand .....	64
<b>Figure 4-6:</b> Comparison of titled solar radiation calculated and monitored.....	65
<b>Figure 4-7:</b> Comparison of PV energy production calculated and monitored .....	65
<b>Figure 5-1:</b> Map of Thailand and location of BPP in Chiang Rai province .....	68
<b>Figure 5-2:</b> Map of BPP village .....	69
<b>Figure 5-3:</b> Weekly demand profile of BPP village generate by RES.....	70

<b>Figure 5-4</b> : Correlation of daily energy demand and energy produced by diesel ....	72
<b>Figure 5-5</b> : Energy balance of the PVHS at BPP .....	73
<b>Figure 5-6</b> : System performance of the PVHS at BPP .....	73
<b>Figure 5-7</b> : Selected weekly power supply by PV, battery and battery SOC.....	74
<b>Figure 5-8</b> : LCC analysis of different assumption .....	75
<b>Figure 5-9</b> : Map of Cambodia, PV system installed and location of Samaki.....	77
<b>Figure 5-10</b> : Weekly demand profile of Samaki village generate by RES.....	78
<b>Figure 5-11</b> : Correlation of daily energy demand and energy produced by diesel ...	79
<b>Figure 5-12</b> : Energy balance of the PVHS at Samaki .....	79
<b>Figure 5-13</b> : System performance of the PVHS at Samaki.....	80
<b>Figure 5-14</b> : Weekly power supply by PV, battery and battery SOC of the PVHS ...	80
<b>Figure 5-15</b> : LCC analysis of different assumption of Samaki .....	82
<b>Figure 5-16</b> : Map of Laos, location of Thapene Village in Loungphrabang.....	83
<b>Figure 5-17</b> : Daily load profile of Thapene village by SERT observation .....	84
<b>Figure 5-18</b> : Weekly load demand profile of Thapene village generate by RES.....	84
<b>Figure 5-19</b> : Correlation of daily energy demand and energy produced by diesel ...	85
<b>Figure 5-20</b> : Energy balance of the PVHS at Thapene.....	86
<b>Figure 5-21</b> : System performance of the PVHS at Thapene.....	86
<b>Figure 5-22</b> : Distribution weekly power supply by PV, battery and battery SOC.....	87
<b>Figure 5-23</b> : Thapene LCC analysis of different assumption .....	88
<b>Figure 5-24</b> : Levelized costs for PVHS, PVS, DGS and GE in selected countries .....	90
<b>Figure 8-1</b> : PVHS grid tried algorithm .....	111
<b>Figure 8-2</b> : PVHS grid forming algorithm .....	112
<b>Figure 8-3</b> : PVS algorithm.....	113
<b>Figure 8-4</b> : SHS algorithm .....	114
<b>Figure 8-5</b> : BCS algorithm .....	115
<b>Figure 8-6</b> : DGS (left) and GE (right) algorithm .....	116
<b>Figure 8-7</b> : Main input user interface of PVHS.....	117
<b>Figure 8-8</b> : Example of Input data of PV panel, inverter and battery inverter.....	117
<b>Figure 8-9</b> : Solar radiation input user interface .....	118
<b>Figure 8-10</b> : Load input user interface .....	118
<b>Figure 8-11</b> : System parameter result interface.....	119
<b>Figure 8-12</b> : Energy consumption result interface .....	119
<b>Figure 8-13</b> : Balance of energy result interface .....	119

**Figure 8-14:** System performance result interface ..... 120

**Figure 8-15:** Economics result interface ..... 120

## TABLE OF TABLES

<b>Table 2-1:</b> Sector contribution to real GDP and growth rate per capita in 2000 .....	13
<b>Table 2-2:</b> Estimates of rural household access to electricity.....	17
<b>Table 2-3:</b> Summary of the overall strategic planning, target and goals for EDC.....	19
<b>Table 3-1:</b> PVHS performance .....	44
<b>Table 4-1:</b> Recommended Average Days for Months and Values of $n$ .....	47
<b>Table 4-2:</b> Nominal and Standard conditions .....	52
<b>Table 4-3:</b> Comparison of RES PVHS calculation and SERT PVHS monitored.....	62
<b>Table 4-4:</b> Comparison of RES PVS calculation and Chiangria PVS monitored .....	64
<b>Table 5-1:</b> Renewable energy resource in BPP .....	69
<b>Table 5-2:</b> Load demand and duration time of used in BPP .....	70
<b>Table 5-3:</b> Comparison of the difference assumption of the PVHS economics.....	75
<b>Table 5-4:</b> Solar energy resource in Samaki .....	77
<b>Table 5-5:</b> Comparison of the difference assumption of the PVHS economics .....	81
<b>Table 5-6:</b> BTP comparison of the difference assumption of the PVHS economics .	88
<b>Table 8-1:</b> Components list .....	101

## **ABBREVIATIONS**

ADB: Asian Development Bank

BPP: Ban Pang Praratchatang

BCS: Centralized PV Battery Charging Station

CORE: Council on Renewable Energy in the Mekong Region

CRO: Central Research Organization

DEDP: Department of Energy Development and Promotion of Thailand

DGS: Stand-Alone Diesel Generator Station

ENCON Fund: Energy Conservation Promotion Fund

EDC: Electricité du Cambodge

EPPO: Energy Policy and Planning Office

EVN: Electricity of Vietnam

FAO: Food and Agriculture Organization

GDP: Gross Domestic Production

GE: Grid Extension

GMS: Greater Mekong Subregion

IEPF: Energy Institute of Francophonic Countries

ISET: Institut für Solare Energieversorgungstechnik

KTOE: Kilo Tones Oil Equipvalent

MGCT: A Study of Mini – Grid Concept for the Villages without Electricity in Thailand

MIME: Ministry of Industry, Mines and Energy

MST: Modular Systems Technology

MTOE: Million Tones Oil Equipvalent

NGO: Non Government Organization

NRCT: National Research Council of Thailand

PEA: Provincial Electricity Authority of Thailand

PV: Photovoltaic

PVHS: PV-Diesel Hybrid System

PVS: Stand-Alone PV Station

PWD: Public Work Division

RES: Rural Electrification System

RWEDP: Regional Wood Energy Development Programme

SB: Sunny Boy

SBC: Sunny Boy Control

SERT: School of Renewable Energy Technology

SHS: Solar Home System

SI: Sunny Island

STEa: Science Technology and Environment Agency



## **1 INTRODUCTION**

### **1.1 Motivation**

Approximately 200 million people of the Mekong Country population live in rural areas. From that number only 10% in Cambodia, Lao PDR, Myanmar and Vietnam have access to the electric grid. The government of the Mekong Countries has a very strong policy to provide electricity to people in those areas. However, there are many problems in the implementation process such as financial, unclear planning and lack of proper technology. Almost all rural electrification projects are concentrating on conventional ways such as grid extension. This technology is sometimes not proper in some locations for example in Lao PDR and Myanmar, where almost all land areas are still covered by abundant forest. Grid extension may be a cause of environment effect and not economical enough because not many people actually live in that area.

Mekong Country has very rich potential of renewable energy. This potential can be developed for rural electrification projects. Renewable energy is wide spread in this region and can be found at all locations. It should be considered for power generation sources because many technologies in this time can convert it into electrical energy such as photovoltaic (PV) generator, wind turbine, hydro generator and biomass conversion technology. One solution for rural electrification in this region is suitable by selecting the proper renewable energy conversion technology.

In this study the focus is photovoltaic generator technology. Long experience has shown this technology is a one of the most efficient for rural electrification. However, many limitations of photovoltaics still exist, such as reliability when compared with diesel generator. But the diesel generator also has many disadvantages. Therefore the combination between the advantages of photovoltaic and diesel generator is one suitable solution for rural electrification technology of the Mekong Country.

The photovoltaic hybrid system is a new technology for this region. There is not much technical experience for application in rural area. No data indicates this technology is suitable for rural areas of this region and it is quite difficult to use the experience from other regions to identify. Mekong region has specific conditions that are different with other regions. Therefore this study concentrates on the suitability and guideline of



use of the photovoltaic hybrid system for rural electrification in Mekong region by studying the technical and economic performance to get exact data for suitable technology selection and suitable guideline for rural electrification in this region.

## **1.2 Hybrid system technology**

Through the combination of renewable energy conversion technology devices, such as photovoltaic, wind turbine or hydro generators, with combustion generator and battery storage, it is possible to generate electricity in rural or remote areas competitively. Such systems are defined as hybrid energy systems and are used to provide electricity to rural village in developing countries. The combination of renewable and conventional energy technology compares favorably in both technical and economical performance with fossil fuel based and conventional grid rural area power supplies. [Wichert, et al, 1999]

Applications of hybrid energy systems range from small power supplies for rural households, providing electricity for lighting, radio and other electrical appliance, to rural electrification for rural communities. Hybrid system technologies have advantages over conventional, combustion generator only in rural area power supplies where the load demand over the day is highly variable. A study of systems installed in the USA concludes that hybrid systems are cost-competitive with conventional systems where the ratio of heavy to light loads exceeds 3:1 [Markvart, 2000]. If the load variability is less pronounced than other constraints, such as limited access or restricted environmental impact, may favor the application of renewable energy technology for rural area power supplies. Many experiences have shown that conventional combustion generator systems are often not suitable enough to respond to changing load demands varying operating conditions.

In this study the AC-couple modular expandable hybrid system concept from the Institut für Solare Energieversorgungstechnik (ISET) is considered. The main components consist of photovoltaic generator, diesel genset, battery storage and power conversion device for the scope of the work. Other renewable energy technology such as wind turbine and hydro generator are not considered for this study.

### **1.3 Software simulations**

One of the most important goals of this research is to evaluate the technical and economic performance of the utilization of AC-couple PV hybrid system concept in the rural area of the Mekong Countries. It is impossible to make the experiment in several real sites because of time consumption and high budget need. Computer simulation is a time saving and cost-effective method that can be used for system design, performance evaluation, optimization and control strategy before a system is installed [Cherus, 2004]. With this way, the behaviour of real systems can be relatively accurately predicted and modified accordingly before implementation. In this study, system static behaviour is of particular interest.

A wide variety of simulation tools, ranging from simple rules of thumb to sophisticated software packages, exist for the analysis and dimensioning of stand-alone photovoltaic systems. System designers and installers use the simple tools for sizing. Scientists and engineers typically use more involved simulation tools for optimization [Turcotte, 2001]. PV hybrid system software simulators on the market are designed with different goals in mind, and have various limitations for solving certain problems. Software tools related to photovoltaic hybrid systems can be classified into two categories: static and dynamic models. Static simulators are used primarily for long-term system performance predictions, economical analysis and component sizing, etc. Examples are, for instance, Hybrid Designer, Hybrid2, INSEL, PV-DesignPro-S, PVS, PVSYST and SOLSIM, which are generally considered suitable for system dimensioning and economic calculations for PV systems over a long-term period, usually annually. Dynamic system simulators give a closer look at system operation and enables study of power management and control strategies. They are able to simulate real system behaviour, but require special simulation environments to do this [Cherus, 2004]. In this study static system simulation of AC-couple modular expandable hybrid system concept is developed.

### **1.4 Objectives of study**

Many people in rural area of Mekong Countries still lack electricity service. Many rural electrification projects in this region are through the government agencies and funding come from both government and donor agencies. Experience shows, almost all of those project failures are mainly caused by technical, economic evaluation and

project management problems. This research concentrates on the technical and economic evaluation view. For technical problems, improper technology selection, design and component selection are main causes. For economic evaluation, lack of economic evaluation of the projects before starting is main cause.

This research needs to study the proper option for rural electrification of Mekong Countries. By offering the **PV Hybrid System**, which an **AC-couple modular expandable component concept** of ISET is a choice for this region. Another concept is not considered in this work. The technical and economic performance from the actual site and from the software simulation need for confirms this proposes. Four specific objectives are proposed.

- Implementation of field tests, monitoring and evaluation of the PVHS at Energy Park of School of Renewable Energy Technology (SERT) in order to test the PVSH working under the metrological conditions of the Mekong Country,
- To develop a software simulation, which studies the technical and economic performance of rural electrification options. This software must be easy to use and understand for the energy planner on rural electrification projects,
- To evaluate the technical and economic performance of the PV Hybrid System (PVHS) base on renewable energy potentials for rural electrification of Mekong Country by using the developed software,
- To give guidance for the possible use of PVHS application in this region, particularly in regard to its technical and economic sustainability.

In this thesis, the law data of Mekong Countries is provided by the Council on Renewable Energy in the Mekong Region (CORE) secretary office. The technical data of the PVHS is base on the prototype at the Energy Park of School of Renewable Energy Technology (SERT) and at DeMoTec of University of Kassel, which is installed under the EU project "Mini-Grid Kit".

## 1.5 Outline of the thesis

**Chapter 1** gives an introduction to the concept of hybrid system technology, the need for simulation software tools, and objectives of study. **Chapter 2** gives an introduction to Mekong Country, rural electrification situations of this region, such as geography and demography, climate conditions, economic situation and rural electrification policy. **Chapter 3** presents the renewable energy potential in Mekong Country, PV hybrid system technology category, prototype of hybrid system for Mekong Country and testing and monitoring of the prototype. **Chapter 4** presents a software concept, model, algorithm and testing. **Chapter 5** presents the different case study from selected Mekong Country, system and economics performance analysis. Conclusions and recommendations are in **Chapter 6**, references are given in **Chapter 7**, and the appendix is in **Chapter 8**.



## **2 RURAL ELECTRIFICATION IN THE MEKONG COUNTRY**

### **2.1 Introduction to Mekong Country**

The Mekong Countries is includes of six countries: The Kingdom of Cambodia, Yunnan province of People's Republic China, Lao PDR, The union of Myanmar, The Kingdom of Thailand and the Socialist Republic of Vietnam. It is a vast area that possesses an enormous wealth and variety of natural resources, including a rich agricultural base, timber and fisheries, minerals and energy in the form of hydropower, coal and petroleum reserves. These resources fuel economic development and support rural livelihoods in an interrelated fashion.

The great majority of these people live in rural areas where they lead subsistence or semi-subsistence agricultural lifestyles. Since the onset of peace in the 1990s, the peoples of the Mekong are experiencing rapid changes and improvements in their living standards and conditions. The Mekong countries are gradually shifting from subsistence farming to more diversified economies, and to more open, market-based systems. In parallel is the growing establishment of commercial relations among the six Mekong countries, notably in terms of cross-border trade, investment and labor mobility.

The rich human and natural resource endowments of the Mekong region have made it a new frontier of Asian economic growth. Indeed, the Mekong region has the potential to be one of the world's fastest growing areas. The Mekong countries are experiencing rapid changes and improvements in their living standards and conditions. Increasingly, modernization and industrialization are emerging from a process of transition and transformation. Yet, much of it remains poor and with out electricity.

#### **2.1.1 Geography and demography**

Mekong Countries cover a land area of some 2.3 million square kilometers. It shares area borders with China in the north, South China Sea in the south, Vietnam in the east and Myanmar (Burma) and Thailand in the west (**Figure 2-1**).

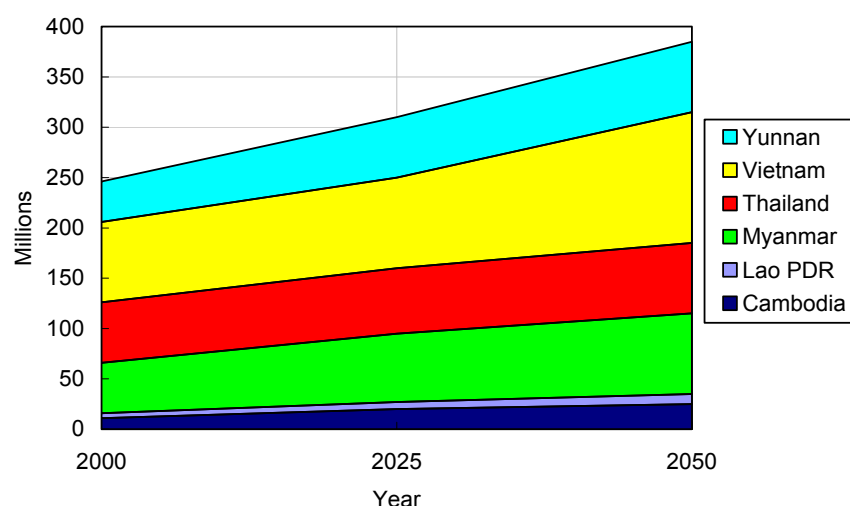

**Figure 2-1:** Map of Mekong Countries

The population of the Mekong region is 250 million, with 65.7 million of these people living within the hydrological basin of the Mekong River. Population growth is rapid and will likely continue in Laos, Cambodia, Myanmar and Vietnam (**Figure 2-2**). The regional population growth rate averages at approximately two percent, although there are marked variations, such as in some of the upland areas of Laos and Vietnam, where higher rates are not uncommon. The region also has an enormously wide range of different population densities. Laos, for example, has only 19 people per square kilometer, while Vietnam ranges from 300-500 people per square kilometer [Nilsson, et al, 2003].

The region's population is overwhelmingly rural. It is estimated that 80 percent of the basin's population lives in rural areas, basing their livelihoods on direct use of the region's relative natural wealth. It is difficult to foresee urbanization trends in the future.

The World Resources Institute estimates that in 2020, 60-70% of the population will still live in rural areas **Figure 2-3**. However, the Nordic Institute of Asian Studies foresees a dramatic urbanization in the following years because of economic growth, as this process seems to have lagged in the region compared to other countries in Asia.



Source: [World Resources Institute, 1998; Asian Development Bank, 1999]

**Figure 2-2:** Mekong Countries population projection

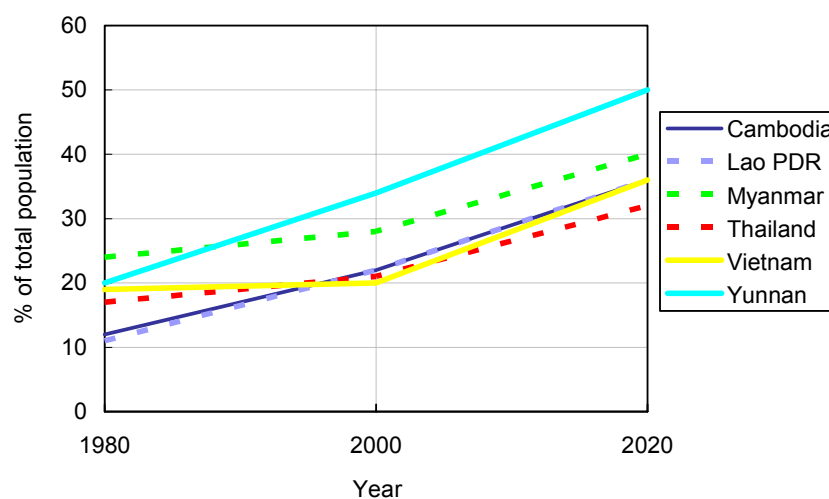

Source: [World Resources Institute, 1998]

**Figure 2-3:** Urban population projection

The Mekong region is characterized by immense population diversity. The uplands are particularly complex in this regard. In Laos, there are as many as 68 ethnic groups comprising almost half of the population. But ethnicity is not a function of



nationality. Almost one million ethnic Khmers live in the Delta region of Vietnam, while there are more ethnic Lao in Thailand than there are within the borders of Laos. Livelihood systems have evolved over time in response to, for example: the hydrological regime, starkly contrasted geographic settings, extreme political events, and uneven access to resources. Although many communities are heavily dependent upon certain activities, in most cases, rural livelihood systems are a complex combination of several activities that contribute towards security.

### 2.1.2 Climate condition

Mekong Countries have very high levels of solar radiation, particularly in the southern region. The maximum average temperature during the hottest months, March to June, is 31 degrees Celsius, with a mean annual temperature of about 16 degree Celsius in the northern regions. Measured on a horizontal surface, daily solar radiation in the south (Cambodia and Vietnam) ranges from 6.5 kWh/m<sup>2</sup> in April and May to 4.5 kWh/m<sup>2</sup> in December, with an average of 5.5 kWh/m<sup>2</sup>. The central regions (Lao PDR and Thailand) have a similar pattern ranging from 4.5 – 6.3 kWh/m<sup>2</sup> over the same months, with an average 5.0 kWh/m<sup>2</sup>. The northern region (Yunnan and Myanmar) range from 5.6 – 7.0 kWh/m<sup>2</sup> over the same months, with average 6.0 kWh/m<sup>2</sup> [NCDC/World Climate/LARC].

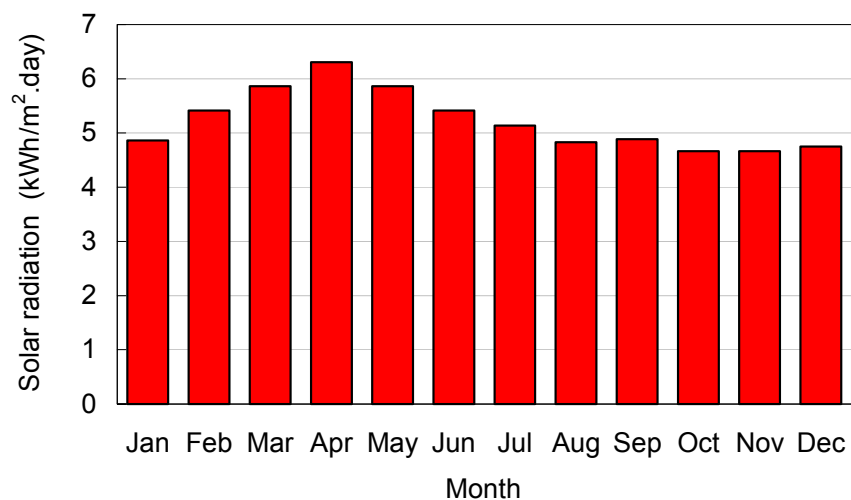

**Figure 2-4:** Solar radiation on horizontal surface of Thailand [DEDE, 1999]

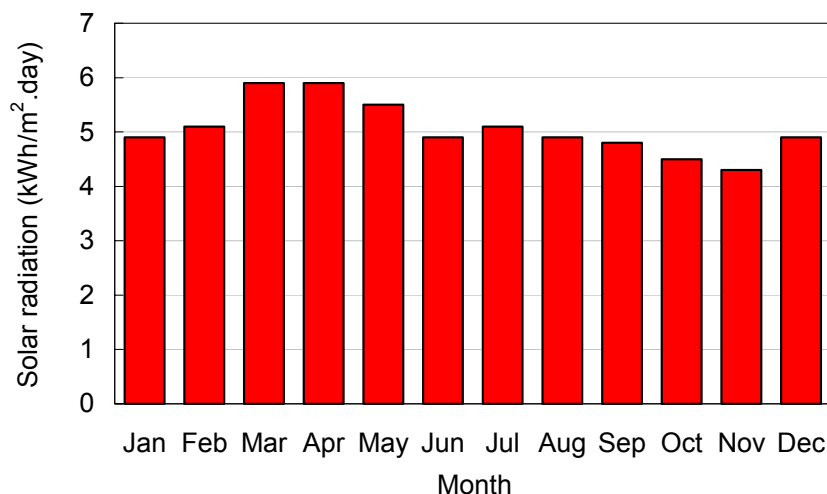

**Figure 2-5:** Solar radiation on horizontal surface of Cambodia [Li, 2002]

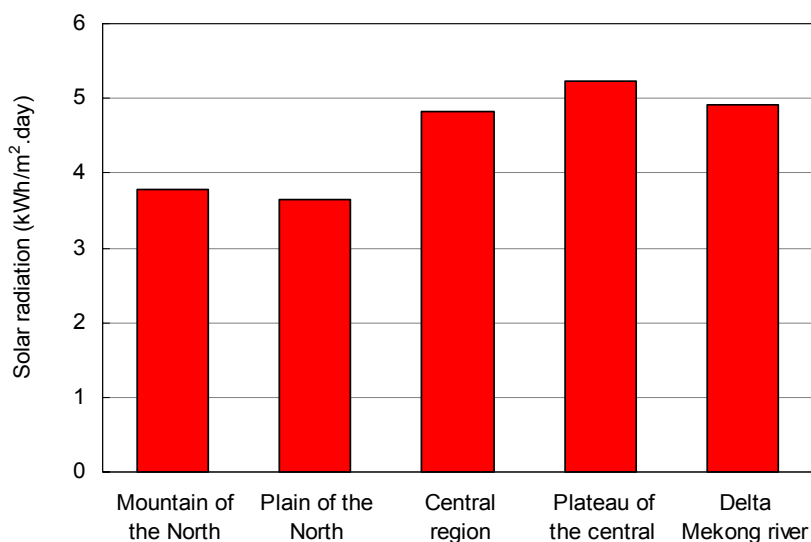

**Figure 2-6:** The average solar radiation in typical region of Vietnam [Le, 1997]

Mekong Countries are characterized by regular rainfall patterns. The mean annual rainfall of the region is 1,500 mm but varies from 1,000 mm in the north (Yunnan) to 3,500 mm in the centre and south region (Cambodia, Lao PDR and Vietnam). Rainfall varies significantly from year to year.

### 2.1.3 Economic situation

Economic growth in the region is rapid, although the countries vary a great deal in economic development. Southeast Asia, in general, enjoyed high economic growth rates in the early to mid 1990s (**Figure 2-7**). In 1997, the economic crisis struck, and growth rates became negative in many parts of Asia. In light of the crisis many

foresaw a slow recovery. However, in late 1999, it was evident that the region would recover more quickly than anticipated. Growth rates are expected to be 2-8% over the coming years [Asian Development Bank, 1999/2001/2004].

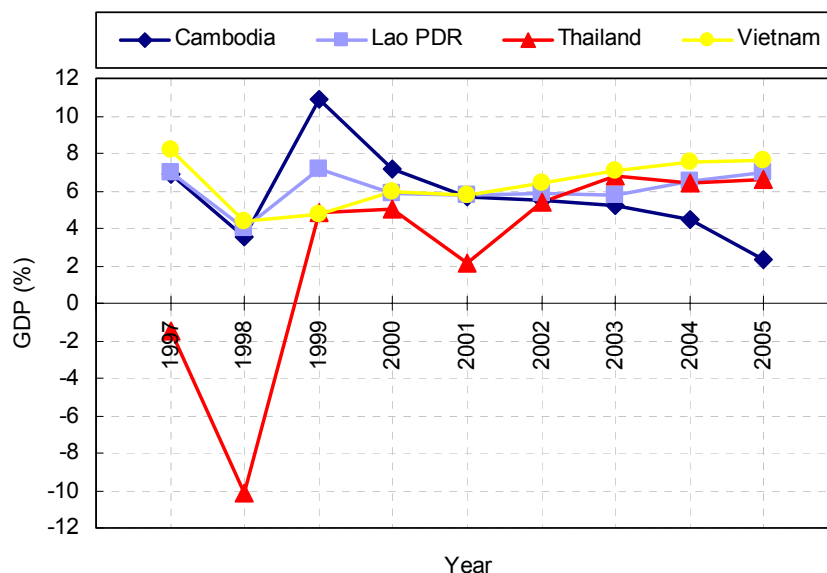

**Figure 2-7:** Selected Mekong Country Gross Domestic Product during 1997-2005

Still, poverty persists throughout the Mekong region's urban and rural area, particularly many parts of the uplands face high levels of poverty. In the region, pervasive rural poverty is taken by many to be the single most critical failure of government policy. Therefore, the pursuit of economic growth is usually a prime objective of all governments. But there are questions related to the impacts of economic growth on equitable and sustainable use of environmental resources.

The Mekong region has had large endowments of natural resources and has relied heavily on the export of natural resources in order to obtain income to import capital and goods. As a result, the Mekong region displays a high degree of dependence on the natural resource base.

**Table 2-1** shows the sector contribution to real Gross Domestic Product (GDP) in 2000 in the six countries and compared to averages for low-, mid-, and high-income countries around the world. "Agriculture" includes agricultural and livestock production, logging, forestry, fishing, and hunting, and is therefore a good proxy for the whole range of land and water resources that we are concerned with. As can be

seen in the table, compared even to other poor countries, there is high resource dependence in Cambodia, Laos, and Myanmar. In the table, Thailand belongs to the Mid Income category.

**Table 2-1:** Sector contribution to real GDP and growth rate per capita in 2000 (% and US\$)

	Agriculture	Industry	Service	GNP/Capita
Regional:				
Cambodia	51	15	34	282
Laos	55	20	25	357
Myanmar	59	10	31	172
Thailand	11	40	49	2,543
Vietnam	26	31	43	330
Yunnan	19	49	32	479
World Average:				
Low income	28	28	43	350
Mid income	11	37	52	1,890
High income	6	31	63	25,890

Source: [Asian Development Bank, 2000/2001]

Throughout the region, national governments, the private sector, and development agencies constitute a strong force pushing for increased economic integration. Regional economic and political integration is generally associated with improved conditions for growth, but it also has implications for the environment.

In the Mekong region, economic integration occurs in parallel with an increased political cooperation, although a political integration, such as Europe (EU), is rather distant. The differences between the economic and political systems are still very far apart, with two highly centralized planning economies (Laos and Vietnam) and two highly market-oriented economies (Thailand and Cambodia). Therefore, integration in the region is characterised primarily by trade liberalization, market expansion through infrastructure investments, and relatively modest political cooperation.

In the context of the Mekong region, the impact on trade flows and economic activities from the formal integration arrangements in the region cannot yet be estimated. Cambodia only joined ASEAN in 1999, Laos and Myanmar in 1997, and Vietnam in 1995. The Asian Development Bank – Greater Mekong Subregion (ADB-GMS) programme was established in the early 1990s. The regional economic crisis abruptly changed trends of trade and growth. Therefore it is difficult to draw any conclusions. However, it is widely anticipated, and also a shared political vision, that

the region as a whole will experience an increased economic integration both regionally and globally.

Expanding markets is an integral part of economic integration, and an explicit objective of many development agencies. It is supported primarily by infrastructure development and investment. Current and planned investments in infrastructure will continue to expand markets into remote areas in the uplands of Laos, Cambodia, and Vietnam, which will have wide-ranging consequences on resource use and access.

## **2.2 Rural electrification situations**

### **2.2.1 Rural electricity needs and development**

For the poor, the priority is the satisfaction of such basic human needs as jobs, food, health services, education, housing, clean water and sanitation. Energy plays an important role in ensuring delivery of these services.

Low energy consumption is not a cause of poverty and energy is not a basic human need. However, lack of energy has been shown to correlate closely with many poverty indicators. Addressing the problems of poverty means addressing its many dimensions. At the household level, although not recognised explicitly as being one of the basic needs, energy is clearly necessary for the provision of nutritious food, clean water and a warm place to live.

In most rural households, particularly the poorest, the amount of useful energy consumed is less than what is required to provide a minimum standard of living. This has led to 'norms' being used by planning agencies when evaluating energy demand in rural areas.

### **2.2.2 General characteristics of rural energy use**

Energy use in rural areas can be broken down into the household, agricultural and small-scale rural industry sub-sectors and services. Since the amount of energy use for services (health clinics, schools, street lighting, commerce, transport, etc.) is generally quite small in rural areas, it is often included in the rural industries sector. A few broad patterns in the use of energy in the rural areas of Mekong Countries can be described [WEC and FAO, 1999].

- Households are the major consumers of energy, their share of gross rural energy consumption averages over 85%. Most of this is consumed in the form of traditional energy sources used for cooking and heating, which constitutes 80 to 90% of the energy used by households.
- Agricultural activities consume from 2 to 8% of the total, depending on levels of mechanisation, mainly in the form of commercial energy used to power mechanical equipment and irrigation pump-sets. In general these statistics do not include human and animal power that provide the bulk of agricultural energy input for the basic agricultural activities.
- Commercial energy, mainly kerosene and electricity where available, is mainly used for lighting, which on average constitutes about 2 to 10% of total rural consumption. Small amounts of electricity are used to operate radios, television sets and small appliances in electrified villages. This has serious implications for many rural electrification projects. *Electricity demand curves in many rural areas are characterised by high peaks in the early evening hours and a low overall consumption, which means high investment in peak capacity installations and low returns.*
- The energy consumption of rural industries, including both cottage industries and village level enterprises, amounts to less than 10% of the rural aggregate in most countries. Woodfuel and agricultural residues constitute the principal sources of supply for these activities, with electricity sometimes providing some motive power.
- Religious festivals, celebrations, burials and other occasional functions may also consume large amounts of fuel but may be missed by energy consumption surveys.

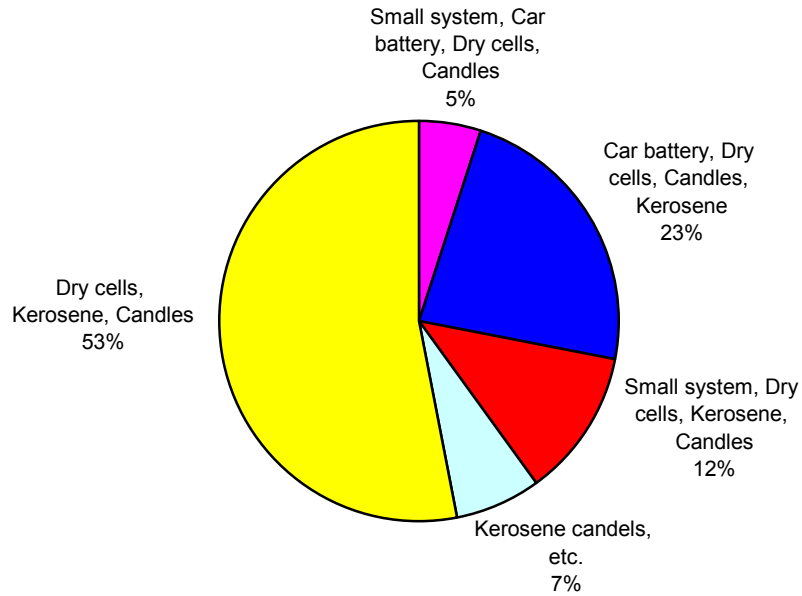

Source: [Anil, 1996]

**Figure 2-8:** Combinations of rural energy source in use in rural Laos

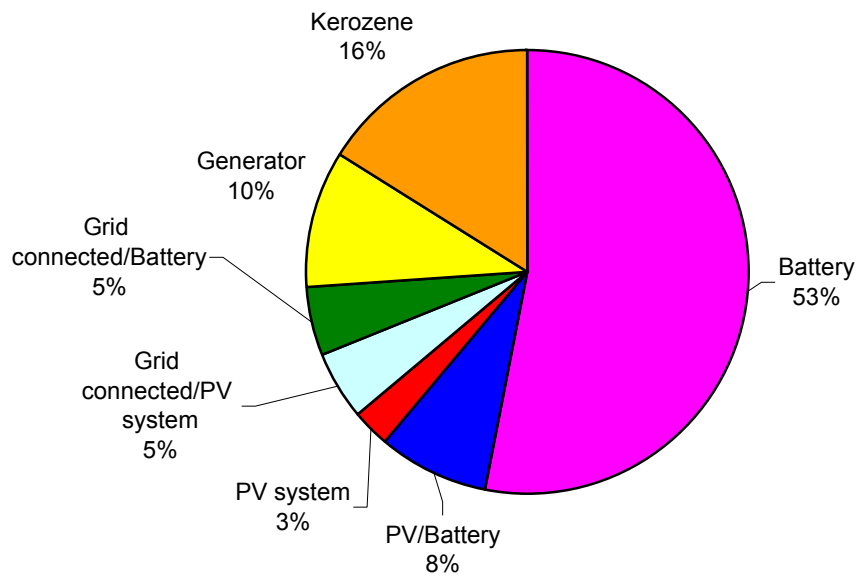

Source: [Li, 2002]

**Figure 2-9:** Rural energy in Pursat province, Cambodia

### 2.2.3 Rural electrification

In rural areas of Mekong Countries, the problem of electricity supplying rural communities is particularly alarming. Supplying power to these areas requires facilities that are not economically viable. However, government programs are under

way to provide this product that is vital to community well being. **Table 2-2** shows the estimates of rural household access to electricity.

**Table 2-2:** Estimates of rural household access to electricity

Country	Rural access
Cambodia	13% <sup>1</sup>
Laos	9%
Myanmar	0.2% <sup>2</sup>
Thailand	99% <sup>3</sup>
Vietnam	14%
Yunnan, China	89% <sup>4</sup>

Source: [Davis, 1995/ <sup>1</sup>Radka, 2005/ <sup>2</sup>Samy, 2005/ <sup>3</sup>Kruangpradit, 2002/ <sup>4</sup>Zuming, 2001]

A nation priority of Mekong Counties is to provide electrical power to people in rural areas, within normal budgetary constraints. Electricity must be introduced into rural areas in ways that maximize the technical, economic and social benefit. Another consideration is the source of electrical generation and the effects on the natural environment.

However, the first attempts to synthesise the emerging experience with rural electrification in developing countries in the early 1980s revealed remarkably few, if any, positive impacts resulting from it. They concluded that benefits tended to be overestimated and the costs understated. More recent studies have often tended to support this initial conclusion. It has also been shown, however, that some rural electrification programmes have been an economic success, as measured by returns on investment. Some of the main distinguishing features between successful and unsuccessful cases have been identified: [WEC and FAO, 1999]

- *Cost-effectiveness.* The goal of universal electric grid coverage often took precedence over considerations of cost or recognition of the point at which alternatives, such as diesel generators for local supplies or diesel engines for pumping, were more viable.
- *Enabling conditions and priorities for rural development.* Rural electrification is more likely to succeed when the overall conditions are right for rural income growth, that is when incentives are present for the development of agriculture and agro-industries and when electrification is based on, or accompanied by, complementary social and economic infrastructure development such as rural water supplies, health programmes, primary and secondary education and regional and feeder roads.



Surveys have shown consistently that these other factors often make rural electrification programmes more meaningful and successful by, for example, generating markets for electricity, leading to higher rates of return on investment. Rural electrification clearly contributes to, but is not a substitute for, other rural development interventions. As simple and straightforward as this may seem on hindsight, it has often been overlooked in the formulation of rural electrification programmes.

Many earlier rural electrification interventions focused on extending the grid. Where grid power is possible and viable there should be no question about providing it. However, in the contentious debate between centralised and decentralised electrification, it has been asserted that decentralised systems do not compete with conventional grid extension. Photovoltaic systems can be used effectively for small isolated loads either as single dwelling systems for lighting, radio and television, or to power special services such as clinic refrigeration, small-scale water pumping or telecommunications. Clearly grid electricity is more versatile and once installed can usually allow for most conceivable increases in demand. However, decentralised options may be attractive for a number of other reasons. Where the demand is uncertain or latent, a diesel generator, for example, will require a lower initial investment and hence the risk of substantial financial loss is reduced. If demand does pick up, a grid connection could be made later and the diesel generator sold or used elsewhere. Small-scale hydro power, although site-dependent, may provide the least-cost option as well as providing a service comparable with grid supply.

### **2.3 Rural electrification policy in selected Mekong Countries**

A priority in the Mekong is to provide electrical power to people in the rural areas as often as possible, within normal budgetary constraints. The services that become available through the use of electricity are essential for communities to maximize their economic and social development potential while ensuring that the natural environment is not compromised. Presently, the people living in rural areas of the Mekong Country still lack the option of public electricity grid service. Given the high cost of grid extension to utilities throughout the developing world, progress in expanding electricity service to non-electrified areas remains slower than population growth [Byrne, 1998]. Off-grid renewable energy systems represent an important

option for narrowing the electricity gap in rural areas of the Mekong Country. Each country in Mekong region sets up the planning of rural electrification. In this part, the policies about rural electrification from selected Mekong Countries are present.

Cambodia: in July 1998 a corporate plan was formulated by taking into account the past performance and the future forecast of Electricité du Cambodge (EDC). The overall content of this plan consists of quality of supply with a reasonable price, customer preference, electrification improvement, human resource management, generation, and transmission and distribution improvement with quality and reliability of supply [SERT, 2000]. **Table 2-3** summarize the overall strategic planning, targets and the goals of EDC.

**Table 2-3:** Summary of the overall strategic planning, target and goals for EDC

Strategy	Target	Goals
Policy	Quality of supply at a reasonable price	Quality of supply: Voltage, Frequency Reliability: LOLP-20 time/yr Outage-18 h/yr (PHN), 20 h/yr (PRVE) Energy Price-\$0.15 (PHN), \$0.18 (PRVE) for regular customers.
Customer Performance	Customers willing to pay	In-age duration: 60 minute (PHN) 120 minute (PRVE) Connection Responsibility-72h Wholesalers = 0
Electrification Improvement	Improvement of the electrification within the coverage area	Electrification rate: 108,000 (PHN), 8,500 (SHV), 6,000 (KGC)
Human Resources Management	Updating of the capability and the efficiency of the personnel and improvement of their participation	Customers per personnel – 90 Upgrade the personnel skill – to 40% Salary US\$ 60
Financial Management	Change EDC to an effective business entity	Expense per Income – 0.94 Current debt – 75 days Bad debt – 5%
Plant availability	Construction of power stations and/or purchasing of the electricity at a reasonable price to serve the coverage area	Goals: 103 MW and 505 GWh (PHN), 9.6 MW and 38 GWh (SKV), 4.3 MW and 18 GWh (SRP), 8.1 MW and 32 GWh (KGC), 5.7 MW and 23 GWh (BTB)
Supply System	Construction and upgrading the distribution system to reach good quality of supply and improvement of the system losses	Availability of supply system: to ensure sufficient power supply for their coverage area. Improvement of the system losses: 15% (PHN's system) and 18% (PRVE)
<b>Note:</b>	PHN – Phnom Penh KGC – Kampong Cham LOLP – Loss – Of – Load Probability	SHV – Sihanoukvill BTB – Battambang SRP – Siem Reap PRVE – Provinces

In Myanmar, hydro and natural gas resources play large roles in generation of electric energy. These two resources will likely form the basis for generation

expansion, since these two resources are relatively available in Myanmar. The power development plan of Myanmar up to 2010 states hydro plants should be added in combination with combined cycle plants. After 2011, hydro power plants along the Thanlwin River will need to be developed. At that time, the surplus of Thanlwin hydropower could be transmitted to neighbor countries.

In Vietnam, since the mid 90s, the strategy for electrification has been to electrify all province capitals and district towns and then gradually extend the network to communes. By the end of 1997 the national grid reached 100% of provincial capitals and 90% of district towns. In order to meet the target of 100% districts and 80% of communes electrified by the year 2000, Electricity of Vietnam (EVN) has decided to extend the national grid to all district towns and communes in the plain and coastal areas. From 2000 to 2010, the target will be to increase connection rates within the communes connected to the grid to achieve 50% of rural households in the mountainous areas. During this period old networks in the plain communes will be upgraded and rehabilitated. From year 2010 to year 2015, the target is to supply 100% communes on the mainland and 90% of households [World Bank and Electricity of Vietnam, 1998].

Thailand; at the end of June 2002, the Provincial Electricity Authority of Thailand (PEA) extended the existing electricity service area to cover 70,014 villages; this constitutes 99% of the total 70,715 villages under the care of the PEA. Of the 701 villages without access to the electricity grid, 549 villages are located in forest conservation areas, wild animal conservation areas, forbidden areas or remote islands where the PEA is unable to extend the grid. The other remaining villages are located in high mountainous regions in the northern part of Thailand with scattered isolated families and hill tribes forming the bulk of the population in these areas. According to a study conducted on remote village electrification, it is not considered economical for the grid line to be extended to such areas. However, the Thai Constitution B.E. 2540 stipulates that one of the basic functions of the government is to provide essential public utilities, including electricity, to every Thai citizen. The electricity provided to the people must be of the same quality and cost, and produced from environmentally friendly power plant that does not cause negative social impact in the vicinity of the power plant. Thus, this provides a good opportunity for the Photovoltaic Systems, which can serve as a suitable environmentally friendly power

plant for these remote villages. Thailand is now the largest Photovoltaic user in Southeast Asia. In the year 2005, Thailand will have installed a total of approximately 30 MW. The Photovoltaic project backed by the government accounts for much of this capacity. This project intends to improve the life of rural people by replacing old style candle light with modern fluorescent lamps. In addition to helping the residents in the rural areas, this project provides a good opportunity for the PV industry of Thailand to take off up. A total of 7,600 million baht (190 million US\$) has been allocated from the government budget to carry out the Photovoltaic project. The project is managed by the Ministry of Interior and implemented by the PEA. Project completion is slated for April 2005 [Ketjoy, 2003/Khunchornyakong, 2004].



### **3 RENEWABLE HYBRID POWER SYSTEM**

The majority of the rural populations in the Mekong Country are dependent on biomass for meeting their energy needs. However, over-utilization of the natural energy resources is rendering the rural energy systems economically and environmentally unsustainable in many parts of the world. In order to deal with this crisis, the countries of the Mekong Country are beginning to strongly promote renewable energy technologies, based on solar, hydro and biomass resources. In the last two decades, several successes, as well as failures, have been experienced which could provide valuable information for formulating policies for better implementation of the renewable energy program in the future [Ketjoy, 2002].

#### **3.1 Renewable energy potential in Mekong Country**

As fossil fuel energy becomes scarcer, Mekong Country will face energy shortages, significantly increasing energy prices and energy insecurity within the next few decades. In addition, Mekong Country's continued reliance on fossil fuel consumption will contribute to accelerating the rates of domestic environmental degradation and global warming. For these reasons, the development and use of renewable energy sources and technologies are increasingly becoming vital for sustainable economic development of Mekong Country. Hydropower, biomass, wind power and solar energy will be the major resources that provide Mekong Country with most of its renewable energy in the future. In this study, the potentials and limitations of these renewable energy sources were assessed for supplying the future needs of Mekong Country. The potential of renewable energy source of the region except Yunnan, China are present below.

##### **3.1.1 Hydro energy**

Cambodia is the one of the regions richest countries in hydropower resources, having the third largest hydropower potential in the Mekong Basin. According to the latest preliminary study the total hydropower potential of the country is estimated at 10,000 MW, of which 50% is in the Mekong, 40% in its tributaries and the remaining 10% in the south-western coastal area outside the Mekong river basin. Cambodia will need to use its hydropower potential in order to meet future electricity demand, to reduce the dependence upon imported fuel, and to allow the exchange of

hydropower with neighboring countries. Before the civil war, the Kirirom hydropower station was running with an installed capacity of 10 MW, and energy was delivered to Phnom Penh through a 110 kV transmission line over a distance of 120 km. This plant was completed in 1968 as the first hydropower station in Cambodia, but it was completely destroyed during the war after only 13 months of operation. However it is being restored by Austrian and Swedish Aid projects. The Prek Thnot project with an installed capacity of 18 MW was implemented near the Kirirom I hydropower station, but the construction was interrupted in 1970 due to the war. Since 1992 there has been only one small hydropower station in Cambodia, and all of the operating generators now are diesel and oil-fired depending on imported oil.

Lao PDR has a hydropower potential of about 22,500 MW within its territory. Up to now, less than 2% of the total potential has been developed with 55 to 60% of the production exported to neighbouring countries. Considering the topography of the country, it can be expected that macro hydropower could be an important source of electrical and possibly mechanical power to rural mountainous areas. At present, macro hydropower stations with a total installed capacity of 615 MW have been completed. Lao has 60,000 cubic meters of renewable water resources per capita, more than any country other country in Asia. There are 35 small/micro hydropower stations that range from 5 kW to 1,600 kW that have operated in parts of country with total installed capacity of 5,653 kW. In remote villages in the North of Laos, hydropower is already being used for lighting, rice mills etc. In recent years, many families in mountainous areas and villages close to streams have been using small pico hydropower generators of capacity between 200 – 5,000 W for their electricity demands. These generators, imported from China and Vietnam, are not high quality but the price is very attractive to Lao PDR [Douangvilay, 2002].

Myanmar planed to establish a mini-hydro system in 1980. Until 1988, 12 units were commissioned and another 9 units were completed by 1991. Nine more mini-hydro projects are currently under way. The rapid progress since 1989 is the result of the change in policy towards involving the people in the projects through financial and voluntary service contributions [SERT, 2000].

In Thailand small hydro power plants with installed capacity of 200 – 6,000 kW have been established since 1980. At present, 23 projects with a total installed capacity of 72.4 MW have been completed. Another two projects with a total installed capacity of 9.95 MW are under construction. Village level or micro hydro power plants with installed capacity smaller than 200 kW have also been constructed. A total installed 2 MW from 71 projects has been completed. Another two projects with a total installed capacity of 210 kW are under construction [SERT, 2000].

Vietnam receives high annual rainfall and has a large network of rivers, streams and springs. The estimated total potential hydro resource is about 20,000 MW at the 570 identified sites; the total installed hydropower capacity was only 2,824 MW in 1995. Currently hydropower is used to produce around 75% of the country's electricity. People living in rural villages have turned to family hydro units to get electricity for lighting and for charging batteries, which are subsequently used for lighting, radio and television [SERT, 2000].

### **3.1.2 Biomass energy**

In almost all Mekong Countries, biomass energy plays a major role in satisfying the rural energy demands. The potential of biomass in each country is presented below.

Cambodia, according to an estimate by the FAO, wood fuel consumption in 1994 was 1.6 MTOE, and accounted for 84% of the total energy consumption in the country. The total potential available from wood fuels during the same year was 24.5 MTOE. Besides, an estimate amount of 0.17 MTOE of agro-industrial processing residues were also available as fuel in 1994. Due to the lack of modern technology in this field the development of the biomass energy is still very low. In Cambodia biomass resources are basically from agriculture wastes and are generally used for cooking and small handicrafts in rural areas. Biomass is also used in the industrial sector for copra drying and steam generation. However, no reliable estimates of the amount of biomass energy consumption for these purposes are available [SERT, 2000].

In Lao PDR, biomass energy plays a major role in satisfying the rural energy demands of Lao PDR. The Science Technology and Environment Agency (STEA) estimates that wood fuels account for the major part, amounting to about 74.4% of



total energy consumption in 1993. According to an estimate of FAO wood fuel consumption in 1993 -1994 was 2.329 million tons and accounted for 89% of total energy consumption in Lao PDR. Also, total potentially available wood fuel during the same year was 49.086 million tons. It is estimated that about 92% of the households use wood fuels for cooking. Beside from wood fuels, an estimated amount of 0.343 million tons of agro-industrial processing residues were also available for use as fuel in 1993 -1994. The energy potential of biogas from recoverable animal wastes in Lao PDR has been estimate to be about 189 KTOE/year. Since 1996, the STEA with the objective of rural area development and promotion of renewable energy utilization has a stated objective of biogas utilization. This is also aimed at increasing the use of organic manure in agriculture and curtails the excessive use of chemical fertilizers. At present, several biogas plants with capacities ranging from 12 to 16 m<sup>3</sup> have been utilized. This will also help decrease the consumption of fuel wood from forests [Douangvilay, 2002].

In Myanmar, Wood fuel made up 75% of total primary energy consumption in the country. This is equivalent to 8,751 KTOE, of which 380 KTOE or 4.35%, was used to produce 111 KTOE used by both the rural and urban populations, while charcoal was used mainly by the urban population. Agriculture residue represents a substantial fuel source. Sufficient data is not available to make an estimate of its potential except in the case of paddy husk. Available data for the year 1988 – 1989 place paddy husk production at 823.8 KTOE, and the production of other crop residue at 1,065.9 KTOE. The amount available for use as energy is estimate to be 271.88 KTOE of paddy husk and 353.25 KTOE of other crop residue. Paddy straw is usually put to higher economic value uses, such as cattle fodder. The supply for the year 2000 -2001 is 1,455.3 KTOE of paddy husk and 1,567.35 KTOE of other crop residue. The energy available for utilization is projected to be 1,091.5 KTOE of paddy husk an 1,175.5 KTOE of other crop residue [SERT, 2000].

Thailand has a fairly large availability of biomass energy resources. It can be utilized in two forms: traditional and modern. In Thailand, the traditional form of biomass energy utilization is mostly applied by domestic sectors and small scale commercial sectors by direct combustion with rather lower efficiency. In the modern form of biomass energy utilization, biomass energies are utilized by newly developed

biomass energy conversion technologies in the form of liquid, gas and electricity such as by producing ethanol, methanol, bio-diesel, biogas and cogeneration. In 2001, the final energy consumption supplied from biomass was about 8.4 MTOE, of which 3.3 MTOE was from wood fuel, 2.3 MTOE from charcoal, 0.9 MTOE from paddy husk and 1.99 MTOE from bagasse. The share of biomass was about one-fifth (18%) of the final energy consumption in the country. It was mainly used in residential and commercial sectors. Almost all fuel wood and charcoal are used for household, while almost all paddy husk and bagasses are used by manufacturing industries. There are a large amount of unexploited biomass resources such as animal wastes, industrial wastes, municipal solid wastes and the other agriculture residues [Sathienyanon, 2003].

In Vietnam, the main biomasses are wood fuel, charcoal, agriculture residues and animal waste. According to an estimate of FAO, the amount of wood fuel consumption in 1994 was 8.8 MTOE. Besides wood fuels, a considerable amount of agro-industry processing residues are also available as fuel in Vietnam. About 32% of all the agro-industry processing residues in Vietnam are used for energy while the rest is wasted. The residues generated from logging activities and wood processing industries, as well as the amount that may be available for energy use, have been estimated to be 2.97 MTOE. Similar estimates by FAO put the figure for the year 1994 at 6.35 MTOE of agro-industrial processing residues representing 2.37 MTOE of energy resource. The combustion of wood fuel and other biomass fuels such as rick husk, bagasse and wood residue has traditionally been in rural industrial furnaces and small-scale industries such as brick kilns and sugar mills. In the domestic sector, the energy-using devices are primarily cook stoves, which have average efficiency in the range of 10-15%. The Institute of Energy has been involved in the development of improved cook stoves with the co-ordination of FAO's Regional Wood Energy Development Programme (RWEDP), the World Bank and the Energy Institute of Francophonie Countries (IEPF) [SERT, 2000].

### **3.1.3 Wind power**

Up to the present, the generation of electricity from wind has yet to be implemented. Cambodia has potential in this resource, especially at the coast and in the mountainous regions where the wind velocity is generally about 10 m/s.

Measurements during 1981 – 1990 at Phonom Pehn indicate that the average wind velocity varies between 4.8 and 14.8 m/s in January and July respectively. There are five units installed using wind energy for water pumping implemented by an NGO for irrigation Prey Veng Province [SERT, 2000].

The potential of wind energy in Lao PDR has not yet been assessed [Douangvilay, 2002]. In 1997, a demonstration wind power plant was installed with a capacity of 1 kW at Xiengkhuang province. Unfortunately, this plant can operate only during the period of dry season from December to March [SERT, 2000].

In Myanmar, Central Research Organisation (CRO) carried out wind velocity surveys in a number of localities in the central regions of the country in the early 1980s. The results obtained can be found in the reference document. Based on that, a number of experiments have been carried out to assess the feasibility of wind turbine based water pumping and electricity generation. In certain remote hilly and coastal areas, the wind velocity is much higher than average for the country [SERT, 2000].

The wind map of Thailand indicates that there are good wind areas during the North-East monsoon, starting from November until late of March. The areas in the Class 3 category (6.4 m/s wind speed at 50m height) or higher are located along the eastern coastline of the southern part of the Gulf of Thailand from Nakhon Srithammarat through Songkla and Pattani provinces, and also over the ridge of Doi Intanon in the Chiangmai province. In addition, the assessment indicates that there are good wind areas during the South-West monsoon, from May until mid-October; they are located on the west side of Thailand stretching from the northern end of the southern region into the parts of the northern region. These areas occur in the mountain ranges through Phetchaburi, Kanchanaburi and Tak provinces. Good wind areas during both the North-East and the South-West monsoons are located in the mountains of the national parks in the southern region. These areas are in Krang Krung national park in Suratthani province, Khoa Luang and Tai Romyen national park in Nakhon Srithammarat, Sri-Phangnga national park of Phangnga, and Khoa Phanom Bencha in Krabi province. The fair wind areas in the Class 1.3 to Class 2 category (4.4 m/s wind speed at 50 m height) or higher are located on the west side of the Gulf of Thailand in Phetchaburi, Prachuabkirikan, Chumphon and Suratthani provinces.

These fair wind areas also occur over mountain ridges in the northern region of the country at Chiangmai and in the north-eastern region in Phetchabun and Loei provinces, which are influenced by the North-East monsoon. They also occur under the influence of the south-west monsoon in the western coastal areas of the southern region at Phangnga, Phuket, Krabi, Trang and Satun, and also on the eastern side of the Gulf of Thailand in Rayong and Chonburi provinces [DEDP, 2001].

Vietnam has a long coast of 3,000 Km and thousands of Islands. In the coastal regions, the wind average speed is 5.6 m/s and over 8.0 m/s on Islands [CORE, 2003]. Wind power has been put into application with some types of wind turbines for water pumping and electricity generation, but the potential for larger scale utilization for grid quality power generation still needs to be study [SERT, 2000].

#### **3.1.4 Solar energy**

Cambodia has a tropical climate with favourable conditions for the utilization of solar energy. Measurements made during 1981-1988 at Phnom Penh indicate that the average sunshine duration varied between 6.1 and 9.7 hours per day in August and December respectively [SERT, 2000]. The country has big potential; solar radiation in kWh/m<sup>2</sup>.d is high: 4.24 in August to 6.34 in March, with the year average of around 5.4 [CORE, 2003].

Lao PDR is situated in the tropical zone in Southeast Asia. The annual mean daily global solar radiation in the country is in the range 4.50-4.70 kWh/m<sup>2</sup>.d, which makes it a potentially good location for solar energy utilization. Solar photovoltaic technology has been introduced in Lao PDR since the 1980s and subjects have been applied successfully in many localities, bringing benefits in remote areas that cannot be reached by national grids [Douangvilay, 2002].

Myanmar has limited reliable solar energy data. Solar energy has been put into application with some types of solar cooker, drier, water still and battery charging but the potential for larger scale utilization for quality power generation still needs to be studied. Only some data of average sunshine hours has been found in the reference [SERT, 2000].

In Thailand, the radiation data has been found from the solar radiation maps of Thailand made by DEDP. Most parts of the country receive the highest solar radiation during April and May, with the values ranging from 5.56 – 6.67 kWh/m<sup>2</sup>.d. The yearly average daily global solar radiation map demonstrates that the region that receive highest solar radiation are in the northeast and the central parts of the country. These regions, which receive the yearly average daily radiation of 5.23 – 5.56 kWh/m<sup>2</sup>.d, represent 14.3% of the country. It was found that 50.2% of the area of the country receives the yearly average daily global solar radiation in the range of 5.00 – 5.23 kWh/m<sup>2</sup>.d and only 0.5 % receive radiation less than 4.44 kWh/m<sup>2</sup>.d. The yearly average daily global solar radiation for the whole country is 5.06 kWh/m<sup>2</sup>.d. This value indicates that Thailand has a fairly high solar energy potentials [DEDP, 2000].

The best climatic conditions for the utilization of solar energy in Vietnam are found in the Southern region. Annual solar radiation in Vietnam is in the range of 3.69 to 5.9 kWh/m<sup>2</sup>, with a yearly average sunshine duration of 1,600-2,720 hours. The solar radiation of Vietnam is an important natural resource. It has quite good potential. The average total solar radiation is about 5.00 kWh/m<sup>2</sup>.d in almost Middle and Southern provinces of Vietnam. In the Northern provinces, the solar radiation is lower, about 4.00 kWh/m<sup>2</sup>.d approximately. South of the 17° parallel, the radiation is good and maintains continuously all year. It reduces about 20 % from dry season to rainy season [CORE, 2003].

### **3.2 PV hybrid system technology category**

To date, PV systems for electrification such as central PV power plants for rural area and roof-top grid-connected PV system for urban households are not economically viable. Based on current economic conditions Solar Home Systems are comparable in cost with grid extension. But the potential for these systems is significant-about 10 MWp for Solar Home Systems and 64-640 MWp for roof-top grid connected PV systems [AIT, 1998].

However, a PV system can be suitable for certain applications and niches, such as remote areas where conventional energy is very expensive or if conventional electrification is not always suitable. One of the most promising applications of renewable energy technology is the installation of hybrid renewable energy systems

in rural areas, where the cost of grid extension is prohibitive and price of fuel increases. Renewable energy sources, such as solar energy, wind or hydropower, provide realistic alternatives to engine driven generators for electricity generation in rural areas. The widely used term Hybrid Energy System describes a stand-alone energy system, which combines renewable and conventional energy sources with batteries for energy storage.

### Category of PV-diesel generator hybrid system

PV-diesel generator hybrid systems generate electricity by combining a photovoltaic array with a diesel generator. They can be categorized according to their configuration as [Wichert, 1999 / Markvart, 2000 / Ketjoy, 2002]:

- *Series hybrid system*

In the series hybrid system (**Figure 3-1**), the energy from diesel generator and a PV array are used to charge a battery bank. The diesel generator is connected in series to the inverter to supply the load. The diesel generator cannot supply the load directly. The inverter converts DC voltage from the battery to AC voltage and supplies to the load. The capacity of the battery bank and inverter should be able to meet the peak load demand. The capacity of diesel generator should also be able to meet the peak load and charge the battery simultaneously.

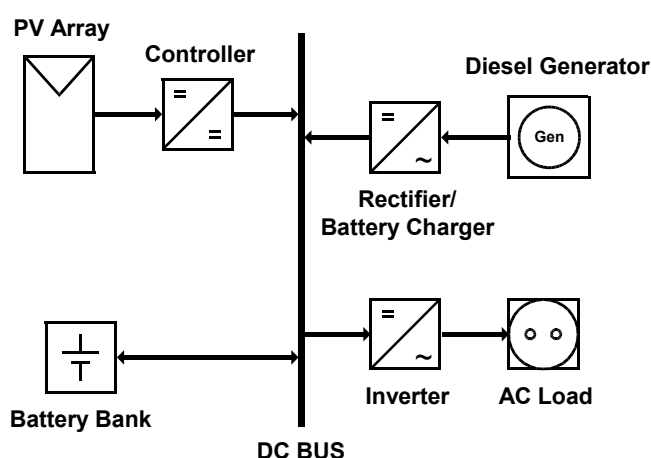
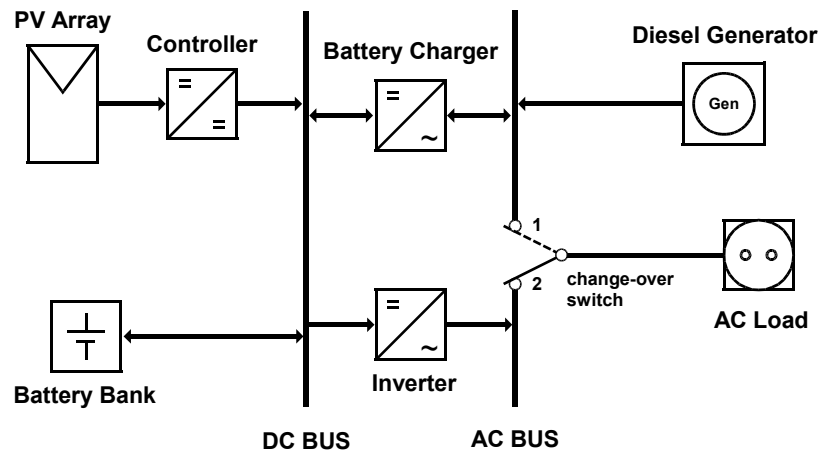

**Figure 3-1:** Series PV-diesel generator hybrid system

- *Switched hybrid system*

The switched hybrid system (**Figure 3-2**), the battery bank can be charged by the diesel generator and the PV array. The load can be supplied directly by the diesel

generator. If the diesel generator output power exceeds the load demand, the excess energy will be used to recharge the battery bank. During period of low electricity demand, the diesel generator is switched off and the load is supplied by the PV array, together with stored energy from the battery bank. When comparing the overall conversion efficiency, switched systems is more efficient than the series system.



**Figure 3-2:** Switched PV-diesel generator hybrid system

- *Parallel hybrid system*

A parallel hybrid system is shown in **Figure 3-3**. The diesel generator can supply the load directly. The PV array and the battery bank are connected in series with the bi-direction inverter to supply the load. During low electricity demand, excess energy from PV array is used to recharge the battery bank. The bi-directional inverter can charge the battery bank when excess energy is available from the diesel generator. Parallel hybrid energy systems have two major advantages over the series and switched hybrid system. The inverter plus the diesel generator capacity, rather than individual component ratings, limit the maximum load that can be supplied. Typically, this will lead to a doubling of capacity. Second, the capability to synchronize the inverter with the diesel generator allows greater flexibility to optimize the operation of the system.

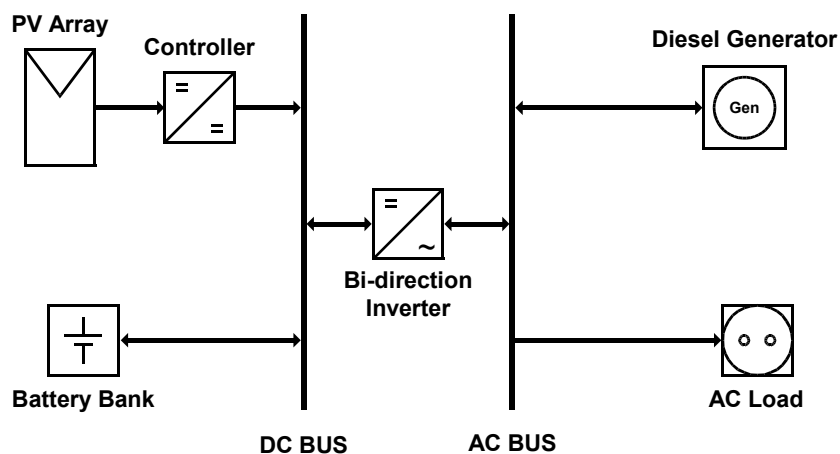

**Figure 3-3:** Parallel PV-diesel generator hybrid system

### 3.3 Prototype of hybrid system for Mekong Country

#### 3.3.1 Modular Systems Technology (MST)

Renewable energy can be efficiently integrated in off-grid regions. In order to offer an uninterrupted power supply, hybrid systems equipped with batteries or combustion engines are applied. The Modular Systems Technology, which supports the design of modular construction kits in different power ranges, has been developed [Landau, 2002].

The prototype of a hybrid system for Mekong Country is different from the general type as presented above. This system concept was innovated by the ISET. The system is called the AC-coupled modular expandable hybrid system. This system is characterized by a stipulated energy coupling (AC-bus bar with e.g. 230/400 V, 50 Hz), a standardized information exchange and a supervisory control. This approach allows setting up an adaptable and expandable system structure, thus covering almost every supply situation; but it means that the generators integrated into the system have to be equipped with special control features [Strauss et. al, 2003].

**Figure 3-4** shows a general diagram of stand-alone off-grid supplied mainly with renewable energy source. The generators can supply the load directly. PV generators and battery storage connected in series with grid inverter and bi-direction inverter respectively supply the load. A battery storage and bi-directional inverter can be applied to balance renewable energy sources to match the load demand. The



advantage of this system is that it can easily increase output power and is extendable from a single phase to three phases.

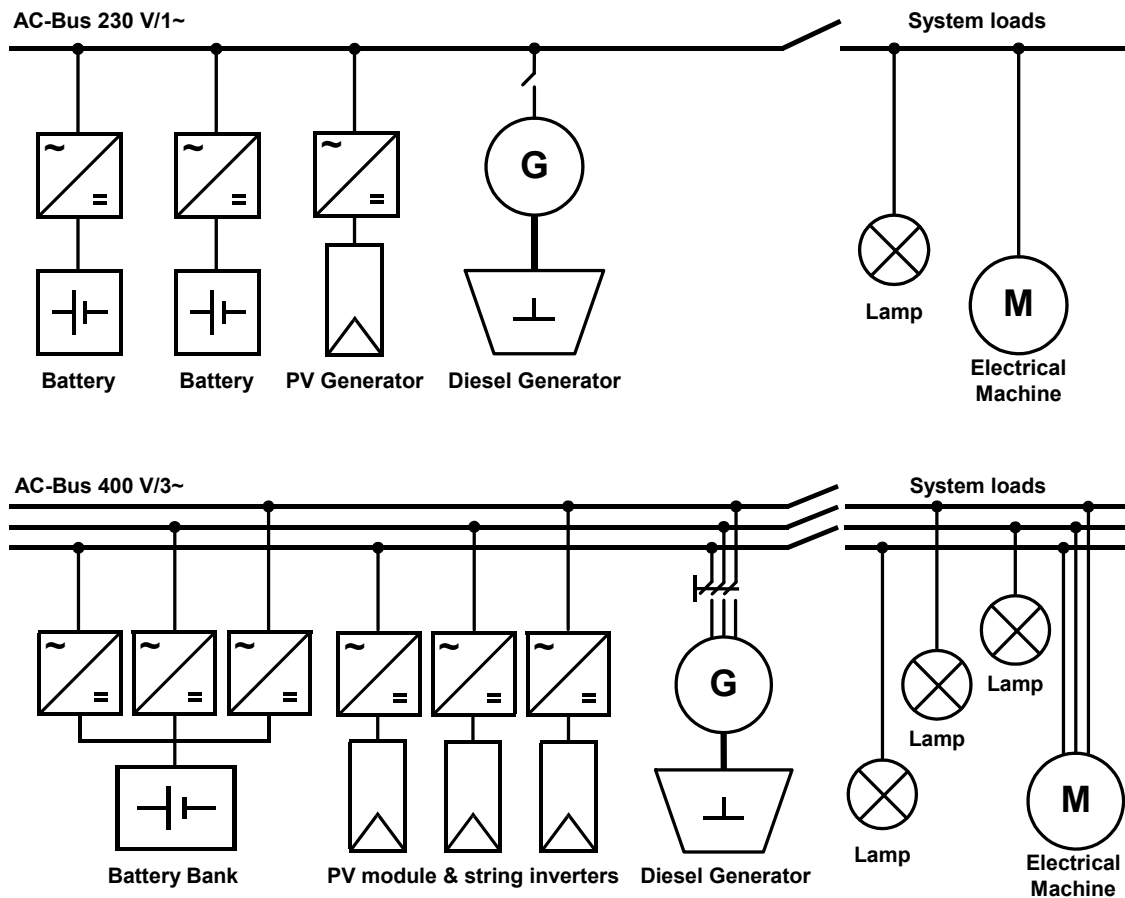

**Figure 3-4:** Single and three phase AC-couple modular expandable hybrid system

According to the actual demand, PV generators can be connected to the AC bus in the same way as it standard grid-connected systems. In other words the string concept for inverters, which has been successfully introduced to grid-connected PV systems, can be used in stand-alone plants as well. Special care has to be taken when using several bi-directional inverters (battery inverter) in parallel. In this case the parallel bi-directional inverters have to divide the loads equally in both directions in case of equal nominal power or proportionally to this figure in case of different values. Conventionally this requirement can be performed using a master slave concept. With a novel approach it could be demonstrated that parallel operating of bi-directional inverters can be performed without using any communication between those units [Schmid, 2001].

### 3.3.2 Classes of power units

The components of such modular systems can be distinguished by their function as either a grid forming unit, a grid supporting unit (controllable generators) or a grid parallel unit (uncontrollable generators and loads) [Strauss et. al, 2003].

*Grid forming unit:* The grid forming unit controls grid voltage and frequency by balancing the power of generators and loads. Standards systems contain just one grid forming unit as a master which can be a diesel generator set or a battery inverter.

*Grid supporting unit:* Being similar to traditional electrical supply system, the grid supporting unit's active and reactive power is determined by voltage and frequency characteristics which allow primary control and power distribution.

*Grid parallel unit:* These units comprise loads and uncontrollable generators. Uncontrollable generators are e.g. wind energy converters without control or PV inverters for grid connection. Both devices are designed to feed as much power into the grid (island grid) as possible.

### 3.3.3 The prototype system at SERT

The hybrid system prototype for rural area of the Mekong Country is installed at the Energy Park area of SERT (**Figure 3-5**) under the framework of the **EU project: Mini-grid-Kit NNE5-1999-00487** and the framework work of the **Energy Park Project** and **NRCT project: A Study of Mini – Grid Concept for the Villages without Electricity in Thailand (MGCT)**. The system consists of 2.0 kW<sub>p</sub> PV generator, 5.0 kW diesel generators, 18.0 kWh battery bank (deep cycle lead-acid type), 2.0 kW Grid connected inverter, 3.3 kW Battery inverter (Bi-directional inverter), Sunny Boy Control and Delphin data logger for measuring, monitoring and recording electrical parameters and 3.0 kW variable simulator load [Ketjoy, 2003]. **Appendix A** presents the detailed drawing of the System.

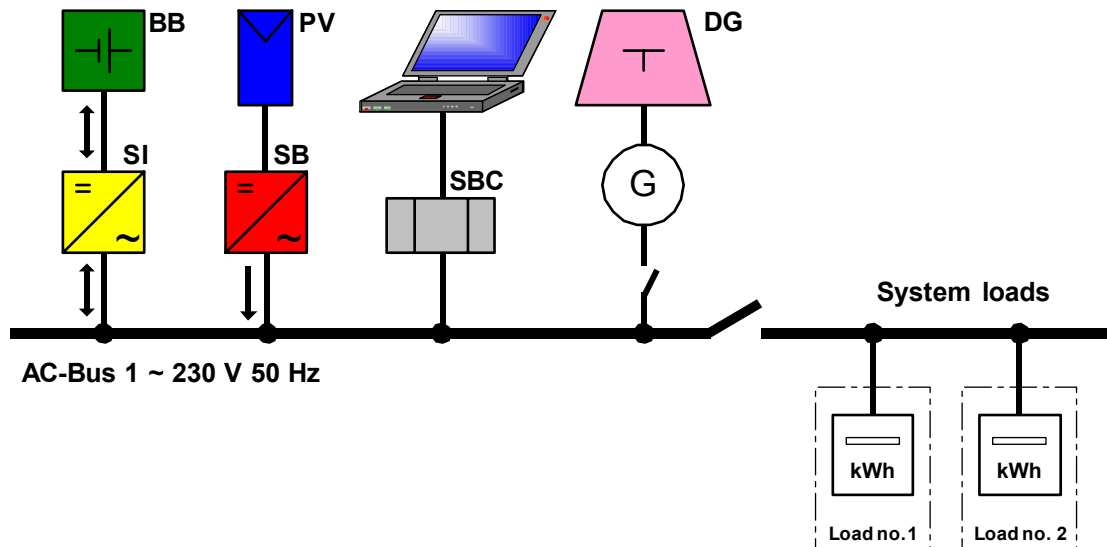

PV: PV generator "BP275F", 75W x 26 modules  
 DG: Diesel generator "Honma 5GFLE", 5 kW  
 SI: Battery inverter "SMA Sunny Island", 3.3 kW  
 BB: Battery bank "Exide OPzS 305", 60V, 305 Ah  
 SB: Grid connected inverter "SMA Sunny Boy 1700E", 2.0 kW  
 SBC: Sunny Boy Control data logger



Figure 3-5: PV Hybrid System prototype at SERT

### 3.4 Testing and monitoring of the prototype

The AC-couple modular expandable hybrid system concept is very new for the Mekong Countries, there is no experience used from the real site. With the budget constraint, the prototype could not install in the real rural areas. To simulate the system under the same conditions of the rural villages, the simulator load has to install for this research. This simulator design very simply by using 6 x 500 W heaters, variable loads control system as possible to operate load from 10 – 3,000 W and the analog timer system for loads profile setting (**Appendix A**).

#### 3.4.1 Test method

Figure 3-6 presents the PVHS performance testing procedure. First the different load profile data from CORE data base are used for this testing. Second, input the load

profile (example of load profile show in **Figure 3-7 to 3-11**) to the load simulator by setting up an analog timer. Third, test the PVHS with loads input and record the data. Repeat the process by changing the selected load profile.

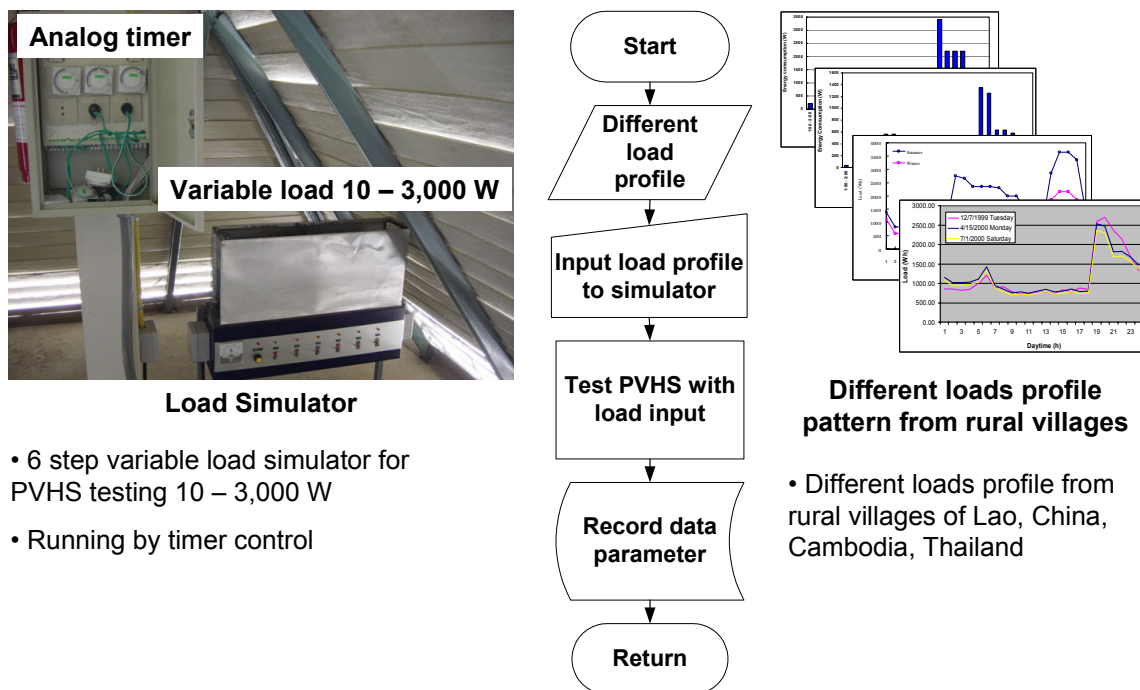

**Figure 3-6:** PVHS performance testing procedure with different loads profile pattern

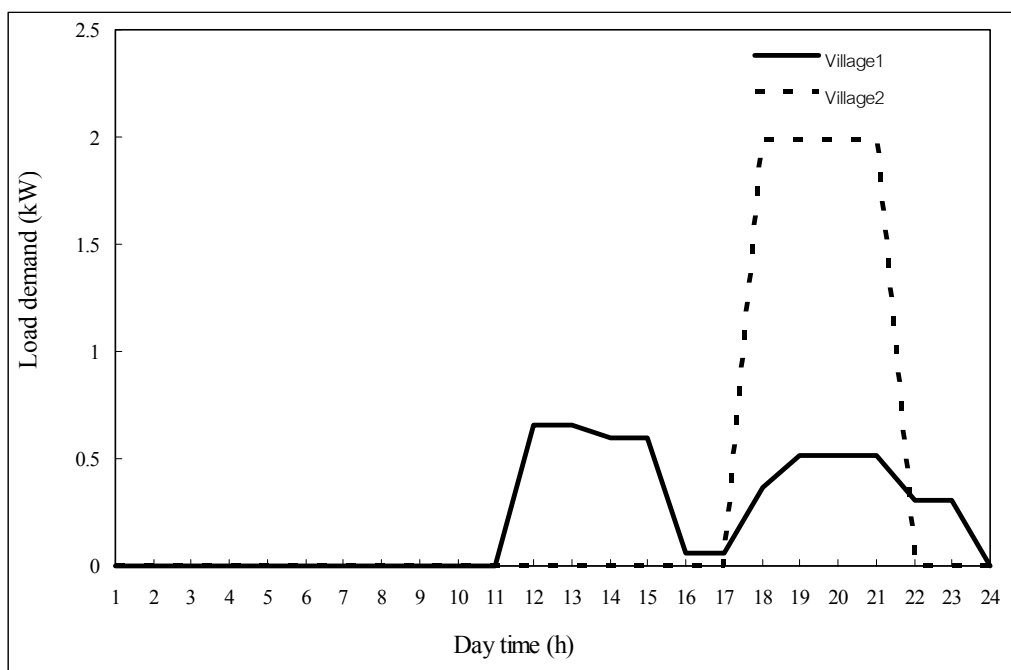

**Figure 3-7:** Load profile of small villages in northern of Thailand [Ketjoy, 2003]

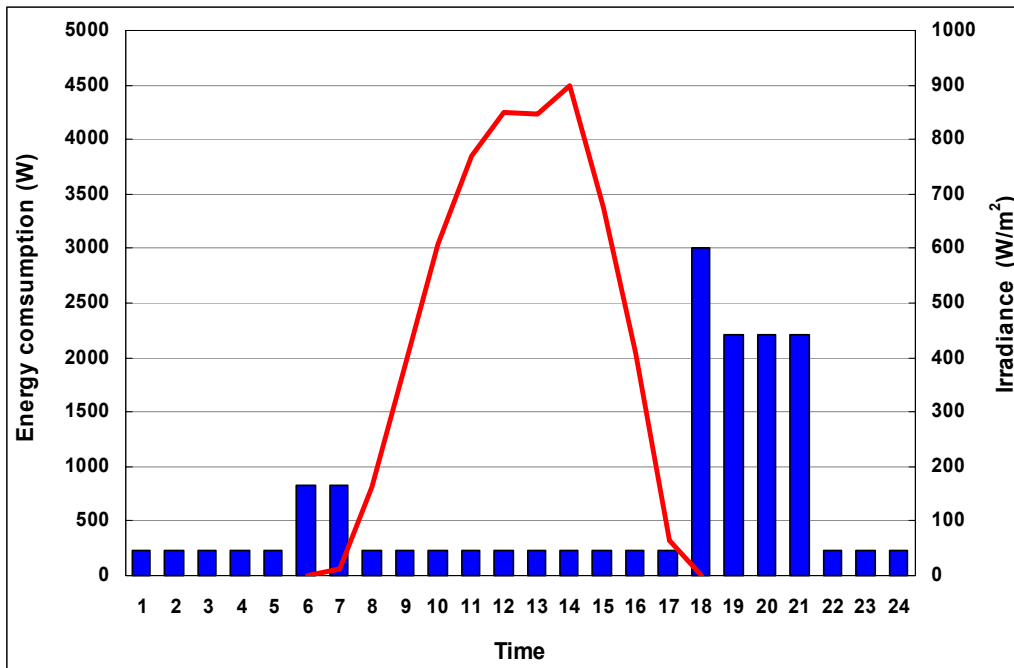

Figure 3-8: Load profile of a single village in Chiangria, Thailand [SERT]

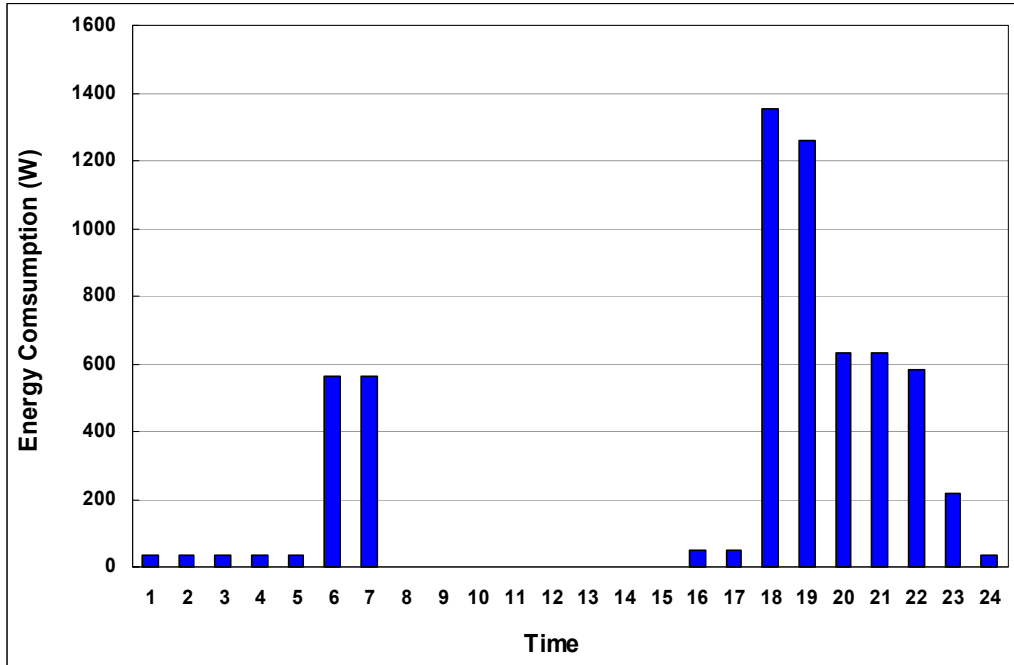
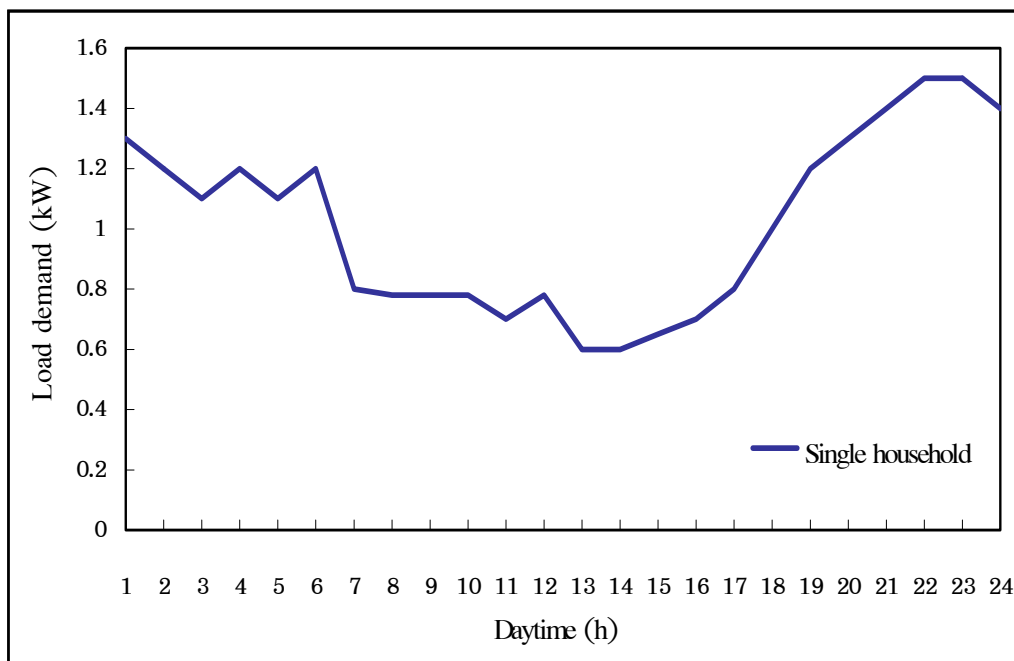
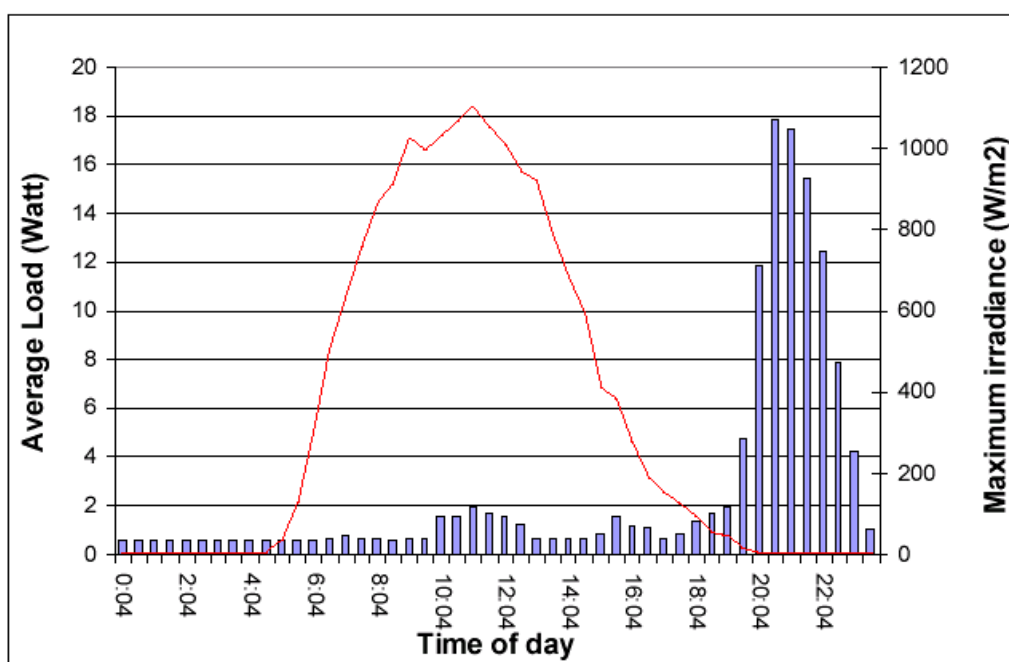

Figure 3-9: Load profile of a Ban Pang Praratchatan village, Thailand [SERT]



**Figure 3-10:** Load profile of a single household in Thailand [Ketjoy, 2003]

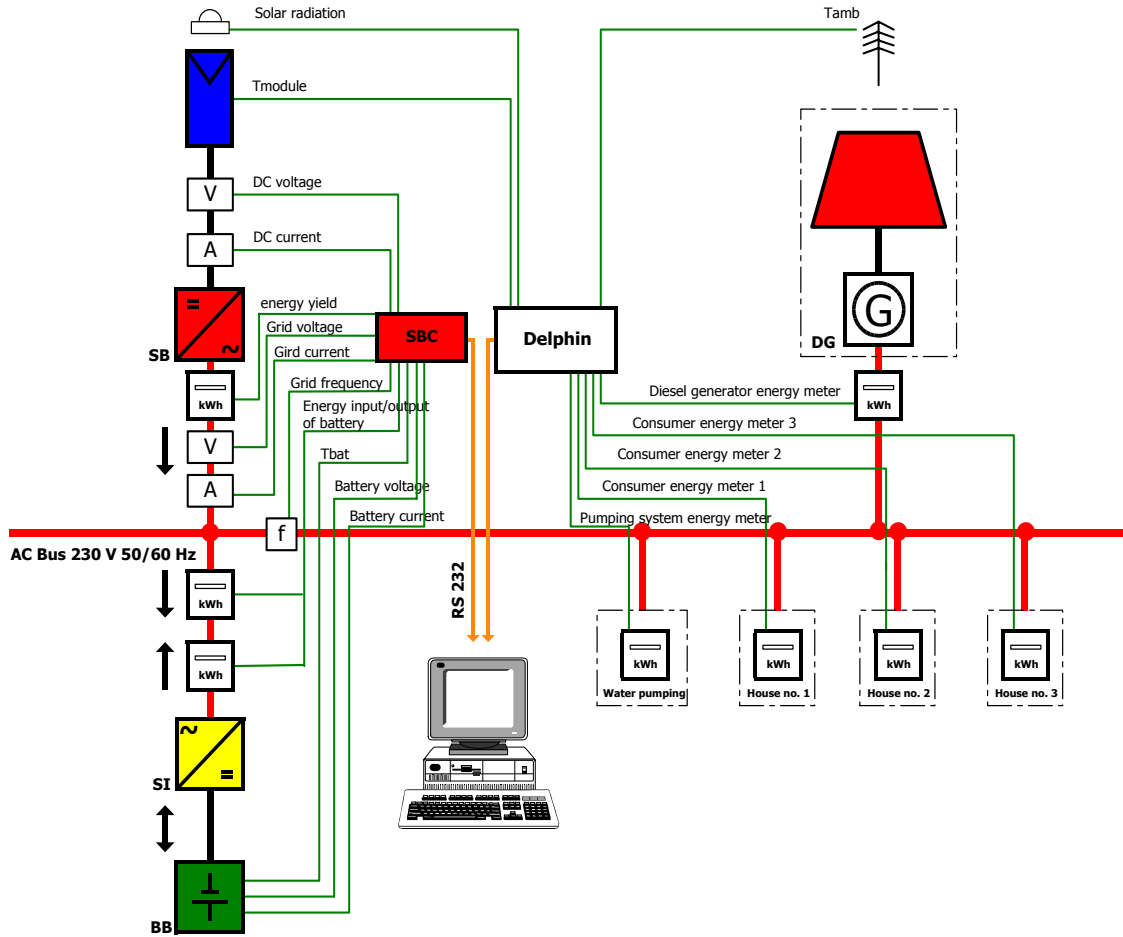

**Figure 3-11:** Hourly of load in Luo Buo Tai Zi, Xinjiang, China [Nieuwenhout, 2001]

### 3.4.2 Data monitoring system

The electrical system parameters of the hybrid system are monitored using the Sunny Boy Control (SBC) data logger from SMA Company and Delphin data logger. The SBC receives system data from the Sunny Boy (SB) and from the Sunny Island (SI) via an RS485 Interface. These data can be read by a PC using an RS232

interface. Further evaluation and data processing can be done with the Sunny Data Control software, and after exporting the data in a common file format, it can be read with any other software [SMA, 2000].



Parameter	Device	Unit
Solar radiation	Delphin	W/m <sup>2</sup>
Ambient temperature (Tamb)	Delphin	°C
Module temperature (Tmodule)	Delphin	°C
Load consume	Delphin	kWh
PV voltage	SBC	V
PV current	SBC	A
Grid voltage	SBC	V
Grid current	SBC	A
Grid frequency	SBC	Hz
SB energy yield	SBC	kWh
SB power	SBC	W
Batt voltage	SBC	V
Batt current	SBC	A
Batt power in/out	SBC	W
Batt temperature	SBC	°C
SOC batt	SBC	%

Figure 3-12: Data monitoring system

### 3.4.3 Data analysis

The energy flow through the system and the performance parameters were calculated on the basis that  $G_t$  is the solar energy incident on the PV modules, while  $E_{nominal}$  is the maximum (theoretical) energy that could be delivered by the modules and  $E_{pv\ use}$  is the actual energy (load consume or AC energy used) used in a day. The nominal energy delivered by the PV module  $E_{nominal}$  is obtained by [Ketjoy, 2002/Ketjoy, 2004]:

$$E_{nominal} = \int_{period} G_t A_{module} \eta_{STCmodule} dt \quad [\text{kWh}] \quad (3.1)$$

Where

$$\eta_{STC,module} = \frac{P_{rate\ module}}{A_{module} G_{STC}} \quad (3.2)$$

and  $\eta_{STC,module}$  is the PV module efficiency under standard testing conditions (1,000 W/m<sup>2</sup>, 25 °C and Air mass 1.5),  $P_{rate\ module}$  is the power rate of module from the manufacturer under STC taken as 75 W,  $G_{STC}$  is the solar radiation incident on the PV modules taken as 1,000 W/m<sup>2</sup>,  $A_{module}$  is the area of the PV module.

The actual energy used by the loads during the day when the measurements were done can be calculated from

$$E_{pv\ use} = E_{consume} \quad [\text{kWh}] \quad (3.3)$$

Where,  $E_{consume}$  is the energy consumption measured by kWh meter. **Figure 3-12** shows a schematic of the components of the PVHS, and the location where the measurements were taken.

The Solar Fraction  $F_{sol}$  is the ratio, as a percentage, of the used solar energy  $E_{pv\ use}$ , to the total energy demand  $E_{demand}$ .

$$F_{Sol} = \frac{E_{pv\ use}}{E_{demand}} \quad (3.4)$$



The Performance Ratio ( $PR$ ) is a characteristic value for the losses. It indicates how close a system in operation comes to the maximum performance given by the solar generator. The performance ratio is defined as the ratio of used solar energy to the nominal energy. The nominal energy represents a theoretical energy production of the PV generator, operated permanently at STC conditions and without any further energy losses. The performance ratio is defined as:

$$PR = \frac{E_{pv\ use}}{E_{nominal}} \quad (3.5)$$

This equation gives the ratio of used solar energy to the nominal producible energy, i.e., the production of energy  $E_{nominal}$  that would be theoretically possible if the PV generator always works with the efficiency ( $\eta_{STC}$ ) reached under standard testing conditions.

The Final Yield ( $FY$ ) gives the daily mean value of the used solar energy per kilowatt installed power of the solar generator ( $P_{nominal} = k P_{rate\ module}$ ) installed.

$$FY = \frac{E_{pv\ use}}{day \cdot P_{nominal}} \quad [h/d] \quad (3.6)$$

The mean PV generator efficiency  $\eta_{PV}$  depends on the radiation conditions  $E_{Solar}$  as well as on the particular operating conditions of the PV generator. It can also be estimated from equation (3.7) as:

$$\eta_{PV} = \frac{E_{PV}}{E_{Solar}} \quad (3.7)$$

The quantity  $\eta_{PV}$  is influenced by the variation of efficiency due to physical effects (dependence of radiation and module temperature, impact of the solar radiation spectrum, reflection on the module's surface) as well as by the losses of the system that are caused by the operating conditions (effect of mounting method, deviations of the operating point from the maximum power point, inverter losses, battery losses and etc.).

### 3.4.4 Technical performance evaluation results

The technical parameters of PVHS were evaluated by radiation, temperature and electrical measurements. The system performance at SERT installations was studied by measuring (at 15 minute intervals during a day of year: Apr 03 – Mar 04) solar radiation, ambient and cell/module temperature, and energy consumed by the load. The evaluations of the system performance are presented as [Ketjoy. 2004]:

#### *Energy consumption*

The yearly energy consumption of this system is 2,619 kWh, average daily energy consumption is 7.2 kWh/d and the energy produced by the diesel generator over the year is 227 kWh. **Figure 3-13** present the correlation of daily average energy consumption and diesel generator energy production for each month during the year.

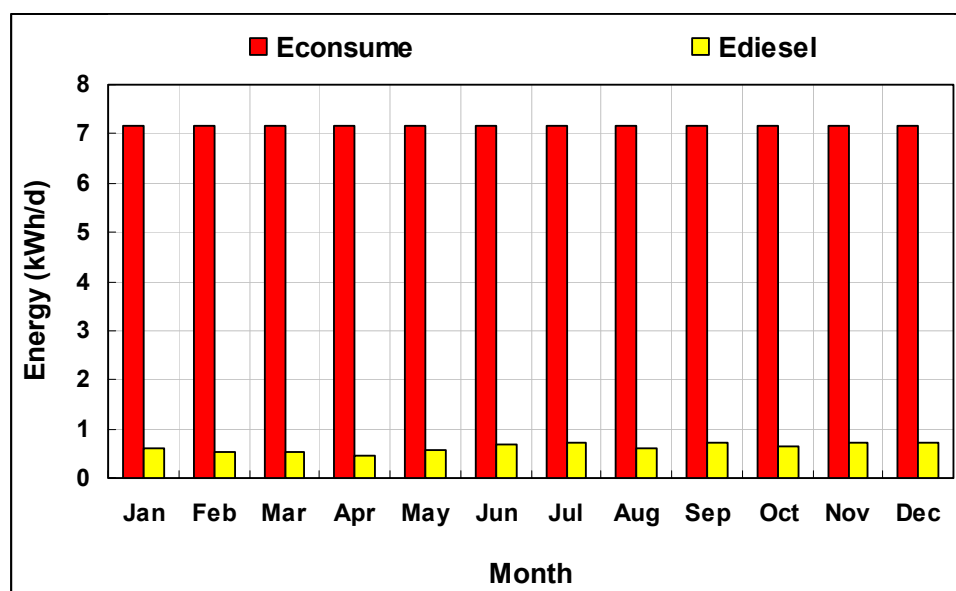

**Figure 3-13:** Correlation of energy consumption and energy produced by genset

#### *Balance of energy*

**Figure 3-14** presents as a brief overview the analysis of energy balance of the PVHS with the equation assumptions as described previous section. The daily average energy produced by PV is 8.7 kWh, the daily average energy produced by diesel generator is 0.6 kWh. The daily average PV energy use is 6.9 kWh. The data shows the energy used produced by PV is about 79%.

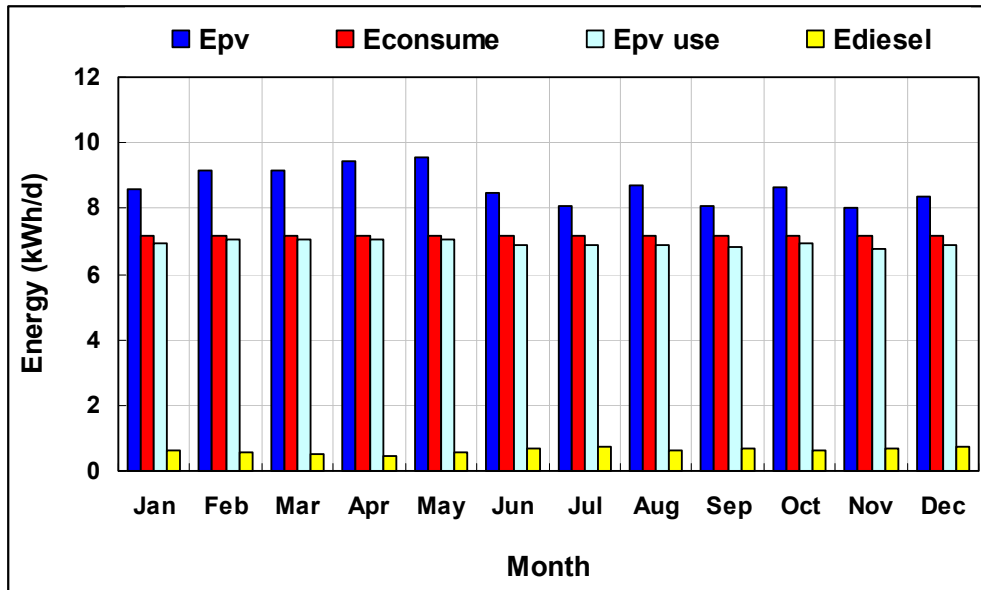

Figure 3-14: Balance of energy of the PVHS at SERT

### System performance

The  $PR$  of 66.6% indicates that on an annual base under the prevailing conditions 33.4% of the nominal energy is not available for load supply due to losses in reflection, higher module temperature, cable and conversion losses, even if the station is continuously used day by day. This potential of the system is comparably high to the potential range of PVHS. All performance indicator values from the monitor are high. One reason is the high uniformity of the irradiation profile throughout the year and the system testing making under controllable load conditions (timer load simulator). Hence, the system performance results are probably higher than under real loads.

Table 3-1: PVHS performance

	Jan	Feb	Mar	Apr	May	Jun	Jul	Aug	Sep	Oct	Nov	Dec	Ave
$G_t$ (kWh/m <sup>2</sup> d)	4.65	5.34	5.47	5.91	5.42	5.31	5.06	5.33	5.48	5.73	5.37	5.33	5.37
$PR$ (%)	68.2	63.8	62.3	59.5	59.7	67.4	71.7	66.1	71.2	66.4	71.7	70.3	66.6
$FY$ (h/d)	3.5	3.6	3.6	3.5	3.6	3.5	3.5	3.5	3.5	3.5	3.5	3.5	3.5
$\eta_{pv}$ (%)	10.1	9.9	9.7	9.6	9.7	9.9	10.1	10.0	10.1	10.0	10.2	10.2	9.9
$F_{sol}$ (%)	96.6	98.1	98.0	98.0	98.2	96.0	96.1	96.2	95.6	96.6	94.7	95.9	96.7

## **4 RURAL ELECTRIFICATION SOFTWARE**

One problem of rural electrification is the difficulty in selecting a suitable technology for the target area. The two parameters technical performance and economic performance are often used as indicators in the evaluation process. In order to evaluate and identify the proper power system technology for rural area application, simulation software called “Rural Electrification System (RES)” is developed for this purpose. RES is developed by the School of Renewable Energy Technology, Naresuan University, in the framework of MGCT projects [Ketjoy, 2003].

### **4.1 Software concept**

RES is a sizing, simulation and economic analysis tool for both renewable energy and conventional energy technology applications. Renewable technology consists of PV-Diesel Hybrid System (PVHS), Stand-alone PV Station (PVS), Solar Home System (SHS) and Centralized PV Battery Charging Station (BCS). Conventional technology consists of Stand-alone Diesel Generator Station (DGS) and Grid Extension (GE). The technical result shows all energy data which are useful when used for comparison with other system types. The economics result shows net present value, life cycle costs and levelized costs of each system which the user can use to compare with another system technology. This software can offer highly accurate results based on the actual meteorological database input by the user for each area. This software serves as a useful tool for energy planners and system designers when selecting the most appropriate rural electrification option and offering the most optimal technical and economic benefits for the people living in rural areas.

This software offers a graphic user interface that is simple and easy to understand. All system components are stored in different libraries to minimize input time by the user. More than 120 models of PV modules from several manufacturers are already included in the database of the software. Integrated help files together with step by step instructions given during the execution of the program ensures that the RES software is a self-learning and user-friendly application tool.

RES provides a wide range of energy supply systems which are already present in its software libraries. The software is divided into two main modules: renewable energy

system and conventional energy system, with their associated sub modules as show in **Figure 4-1**. All systems can simulate both technical and economic performances except the grid extension sub module which only can simulate economic analysis [Ketjoy, 2003].

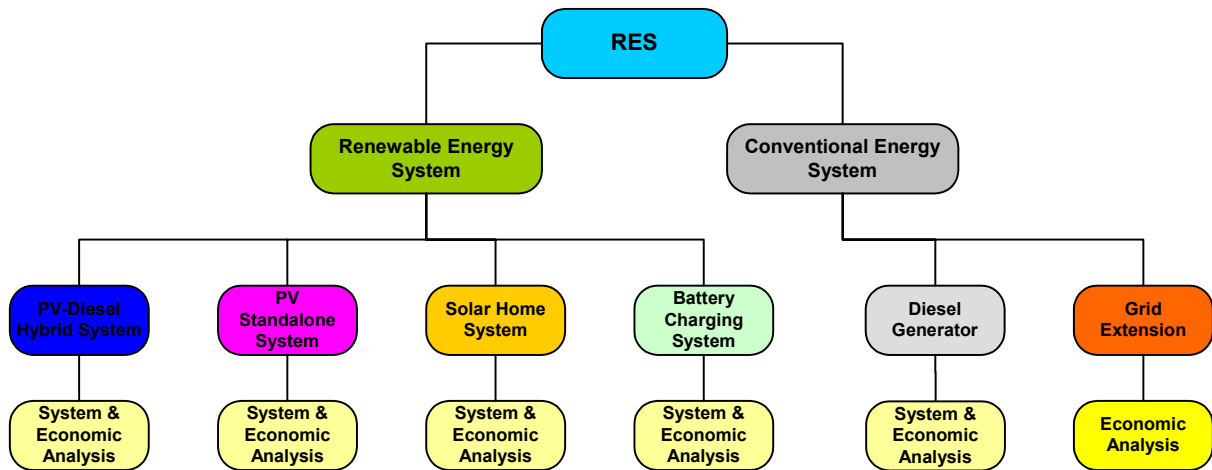

**Figure 4-1:** Structure of the RES

## 4.2 Model and algorithms

This section describes the various algorithms used to calculate, on a month-by-month basis, the energy production of PV systems in RES. A flowchart of the algorithms is shown in **Figure 8-1** to **Figure 8-6 (Appendix B)**. The basis of solar energy is covered in *Section 4.2.1*, which describes the tilted radiation calculation algorithm that is common to all renewable energy system models (PVHS, PVS, SHS and BCS). It is used to calculate solar radiation in the plane of the PV array, as a function of its operation, given monthly mean daily solar radiation on a horizontal surface. *Section 4.2.2* presents the photovoltaic array model, which calculates PV array energy production given ambient temperature and available solar radiation. This algorithm is also common to all application models. Then four different application models are used to evaluate the interaction of the various components of the PV system and predict how much energy can be expected from the PV system on an annual basis. *Section 4.2.3* presents the economic model, which calculates an economic performance (LCC, NPV and COE) of the system. This algorithm is common to all six application model (**Figure 4-1**). A validation of the RES is presented in *Section 4.3*.

### 4.2.1 Solar radiation model

#### ***Extraterrestrial radiation on a horizontal surface and clearness index***

Solar radiation at normal incidence received at the surface of the earth is subject to variations due to change of the extraterrestrial radiation. The calculation of the theoretical possible extraterrestrial radiation is necessary to obtain the ratio of radiation level under the atmosphere. It is often necessary for the calculation of daily solar radiation to have the integrated daily extraterrestrial radiation on a horizontal surface ( $H_0$ ) over the period from sunrise to sunset. The monthly mean daily extraterrestrial radiation, ( $\overline{H_0}$ ), is a useful quantity [Duffie, 1991]. For latitudes in the range of +60 to -60, it can be calculated with Equation (4.1) using  $n$  and  $\delta$  for the mean day of the month from **Table 4-1**.

**Table 4-1:** Recommended Average Days for Months and Values of  $n$

Month	Jan	Feb	Mar	Apr	May	Jun	July	Aug	Sep	Oct	Nov	Dec
Date	17	16	16	15	15	11	17	16	15	15	14	10
Day of year ( $n$ )	17	47	75	105	135	162	198	228	258	288	318	344

$$\overline{H_0} = \frac{24 \times 3600}{\pi} G_{SC} \left( 1 + 0.033 \cos \frac{360n}{365} \right) \times \left( \cos \phi \cos \delta \sin \omega_S + \frac{\pi \omega_S}{180} \sin \phi \sin \delta \right) \quad (4.1)$$

Where:

$G_{SC}$  = Solar constant, 1,376 W/m<sup>2</sup>

$n$  = The day of the year.

$\delta$  = Monthly mean solar declination, Degrees

$\omega_S$  = Sunset hour angle, Degrees

$\phi$  = Latitude of location, Degrees

$\overline{H}$  = Monthly mean daily total radiation on horizontal surface, MJ/m<sup>2</sup>.day

$\overline{H_0}$  = Monthly mean daily extraterrestrial radiation on horizontal surface, MJ/m<sup>2</sup>.day

Before reaching the surface of the earth, radiation from the sun is attenuated by the atmosphere and the clouds. The ratio of solar radiation at the surface of the earth to

extraterrestrial radiation is called the clearness index. Thus the monthly average clearness index,  $\bar{K}_T$ , is defined as:

$$\bar{K}_T = \frac{\bar{H}}{H_0} \quad (4.2)$$

Where  $\bar{K}_T$  values depend on the location and the time of year considered; they are usually between 0.3 (for very overcast climates) and 0.8 (for very sunny locations).

### **Calculation of hourly global and diffuse irradiance**

Solar radiation can be divided into two components: beam or direct radiation, which is radiated from the sun to earth surface directly, and diffuse radiation, which is reflected and/or scattered by small matter in the atmosphere such as clouds or water drops, then to the earth surface [Duffie, 1991/RETScreen, 2003].

Monthly average daily diffuse radiation  $\bar{H}_d$  is calculated from monthly average daily global radiation  $\bar{H}$  using the equation (4.3):

$$\frac{\bar{H}_d}{\bar{H}} = 1.391 - 3.560\bar{K}_T + 4.189\bar{K}_T^2 - 2.137\bar{K}_T^3 \quad (4.3)$$

When the sunset hour angle for the average day of the month is less than  $81.4^\circ$ , and:

$$\frac{\bar{H}_d}{\bar{H}} = 1.311 - 3.022\bar{K}_T + 3.427\bar{K}_T^2 - 1.821\bar{K}_T^3 \quad (4.4)$$

When the sunset hour angle is greater than  $81.4^\circ$  (the monthly average clearness index,  $\bar{K}_T$  is calculated through equation (4.2).

Then, average daily radiation is then broken down into hourly values. This is done with the formula from Collares-Pereira and Rabl for global irradiance.

$$r_t = \frac{\bar{I}_t}{H} = \frac{\pi}{24} (a + b \cos \omega) \frac{\cos \omega - \cos \omega_S}{\sin \omega_S - \frac{\pi \omega_S}{180} \cos \omega_S} \quad (4.5)$$

$$a = 0.409 + 0.5016 \sin(\omega_S - 60) \quad (4.6)$$

$$b = 0.6609 + 0.4767 \sin(\omega_S - 60) \quad (4.7)$$

Where:

$r_t$  = Ratio of hourly total radiation to daily total radiation

$\bar{I}_t$  = Hourly mean total radiation on horizontal surface, MJ/m<sup>2</sup>.h

$\omega$  = Hour angle, Degrees

The formula from Liu and Jordan for diffuse irradiance:

$$r_d = \frac{\bar{I}_d}{H_d} = \frac{\pi}{24} \frac{\cos \omega - \cos \omega_S}{\sin \omega_S - \frac{\pi \omega_S}{180} \cos \omega_S} \quad (4.8)$$

Where:

$r_d$  = Ratio of hourly diffuses radiation and daily total diffuse radiation

$\bar{I}_d$  = Hourly mean diffuse radiation on horizontal surface, MJ/m<sup>2</sup>.h

Correlation between hourly total, beam and diffuse radiation is:

$$\bar{I}_t = \bar{I}_b + \bar{I}_d \quad (4.9)$$

Where:

$\bar{I}_t$  = Hourly mean total radiation on horizontal surface, MJ/m<sup>2</sup>.h

$\bar{I}_b$  = Hourly mean beam radiation on horizontal surface, MJ/m<sup>2</sup>.h

$\bar{I}_d$  = Hourly mean diffuse radiation on horizontal surface, MJ/m<sup>2</sup>.h

### **Radiation on a tilted surface and its estimation**

Hourly radiation on a tilted surface is given by: [Duffie, 1991]

$$\bar{I}_T = \bar{I}_b R_b + \bar{I}_d \left( \frac{1 + \cos \beta}{2} \right) + \bar{I}_t \rho_g \left( \frac{1 - \cos \beta}{2} \right) \quad (4.10)$$



Where:

- $I_T$  = Hourly mean diffuse radiation on tilted surface, (MJ/m<sup>2</sup>.h)
- $\beta$  = PV array tilted angle, Degrees
- $\rho_g$  = Ground albedo (0.2 for non-snow cover)

Ratio of beam radiation on PV array tilted surface to that on horizontal surface determined by: [Duffie, 1991]

$$R_b = \frac{\cos \theta}{\cos \theta_z} = \frac{\sin \delta \sin \phi \cos \beta - \sin \delta \cos \phi \sin \beta \cos \gamma + \cos \delta \cos \phi \cos \beta \cos \omega + \cos \delta \sin \phi \sin \beta \cos \gamma \cos \omega + \cos \delta \sin \beta \sin \gamma \sin \omega}{\cos \phi \cos \delta \cos \omega + \sin \phi \sin \delta} \quad (4.11)$$

### **Estimation of Ambient Temperature**

The ambient temperature can be estimated by using the sinusoidal ambient temperature model which is based on the variation of maximum and minimum ambient temperatures in a day [Ketjoy, 1999].

$$T_{amb}(t) = \frac{1}{2} \left[ (T_{max} + T_{min}) + (T_{max} - T_{min}) \sin \left( \frac{2\pi}{24} t \right) \right] \quad (4.12)$$

Where:

- $T_{amb}(t)$  = Ambient temperature at time,  $t$
- $T_{max}$  = Maximum ambient temperature of the day
- $T_{min}$  = Minimum ambient temperature of the day
- $t$  =  $h - 9$
- $h$  = Considered time in unit of hour

## **4.2.2 System component model**

### **PV Generator**

A photovoltaic generator is the whole assembly of solar cells, connections, protection parts, supports etc. This section presents the model focusing only on cell/module/array. Steps in calculation of PV module current, under certain operating conditions are presented below [Hansen, 2000/ Castañer, 2002]:

$$P_{\max,0}^C = \frac{P_{\max,0}^M}{(N_{SM} \times N_{PM})} \quad (4.13)$$

$$V_{OC,0}^C = \frac{V_{OC,0}^M}{N_{SM}} \quad (4.14)$$

$$I_{SC,0}^C = \frac{I_{SC,0}^M}{N_{PM}} \quad (4.15)$$

$$V_{t,0}^C = \frac{mkT_0^C}{e} \quad (4.16)$$

$$v_{OC,0} = \frac{V_{OC,0}^C}{V_{t,0}^C} \quad (4.17)$$

$$FF = \frac{(v_{OC,0} - \ln(v_{OC,0} + 0.72))}{(v_{OC,0} + 1)} \quad (4.18)$$

$$FF_0 = \frac{P_{\max,0}^C}{(V_{OC,0}^C \times I_{SC,0}^C)} \quad (4.19)$$

$$r_s = 1 - \frac{FF}{FF_0} \quad (4.20)$$

$$R_s^C = \frac{r_s \times V_{OC,0}^C}{I_{SC,0}^C} \quad (4.21)$$

Where:

$P_{\max,0}^C$  = Maximum power for the cell

$P_{\max,0}^M$  = Maximum power to the module

$V_{OC,0}^C$  = Open circuit voltage for the cell

$V_{OC,0}^M$  = Open circuit voltage for the module

$I_{SC,0}^C$  = Short circuit current for the cell

$I_{SC,0}^M$  = Short circuit current for the module

$N_{SM}$  = Number of cells in series

$N_{PM}$  = Number of cells in parallel

$V_{t,0}^C$  = Thermal voltage in the semiconductor of a single solar cell at STC

$m$  = Idealising factor

$k$  = Boltzmann's constant,  $k = 1.381 \times 10^{-23}$  J/K

- $T_0^C$  = Cell temperature at standard condition = 25 °C  
 $e$  = Electron charge  $e = 1.602 \times 10^{-19}$  C  
 $V_{OC,0}$  = Open circuit voltage  
 $FF$  = Fill factor  
 $FF_0$  = Fill factor at standard condition  
 $r_s$  = Series resistance  
 $R_S^C$  = Equivalent serial resistance of the cell

### Cell Parameters for operating conditions

$$C_1 = \frac{I_{SC,0}^C}{G_{a,0}} \quad (4.22)$$

$$I_{SC}^C = C_1 \cdot G_a \quad (4.23)$$

$$T^C = T_a + C_2 \cdot G_a \quad (4.24)$$

$$V_{OC}^C = V_{OC,0}^C + C_3(T^C - T_0^C) \quad (4.25)$$

$$V_t^C = \frac{mk(273 + T^C)}{e} \quad (4.26)$$

Where:

- $C_2$  = Constant,  $C_2 = 0.03$  Cm<sup>2</sup>/W  
 $C_3$  = Constant, usually considered to be  $C_3 = -2.3$  mV/°C  
 $G_{a,0}$  = Irradiation, W/m<sup>2</sup>  
 $G_a$  = Ambient irradiation, W/m<sup>2</sup>  
 $T_a$  = Ambient temperature, °C  
 $T^C$  = Working temperature of the cell

### Module current for operating conditions

$$I^M = N_{PM} I_{SC}^C \left[ 1 - \exp \left( \frac{V^M - N_{SM} V_{OC}^C + I^M R_S^C \frac{N_{SM}}{N_{PM}}}{N_{SM} V_t^C} \right) \right] \quad (4.27)$$

Where:

$I^M$  = Total generated current by the module

$V^M$  = Applied voltage at the module's terminals

**Table 4-2:** Nominal and Standard conditions

Nominal conditions	Standard conditions
Radiation: $G_{a,ref} = 800 \text{ W/m}^2$	Irradiation: $G_{a,ref} = 1000 \text{ W/m}^2$
Ambient temperature : $T_{a,ref} = 20 \text{ }^\circ\text{C}$	Cell temperature : $T_0^C = 25 \text{ }^\circ\text{C}$

*Array current for operating conditions*

$$I^A = \sum_{i=1}^{M_P} I_i \quad \text{or} \quad (4.28)$$

$$I^A = M_P \cdot I^M \quad (4.29)$$

Where:

$I^A$  = Total current of the array

$M_P$  = Number of modules in parallel

*Power generated by PV array*

$$P^A = I^A \times V^A \quad (4.30)$$

Where:

$P^A$  = Power generated by PV array

$I^A$  = Total generated current by the PV array

$V^A$  = Applied voltage at the PV array

Note: In order to have a clear specification of which element (cell or module) the parameters in the mathematical model regard, the following notation is used from now on: the parameters with superscript "M" are referring to the PV module, while the parameters with superscript "C" are referring to the solar cell.

### **Energy output from Inverter**

The PV arrays produce DC power and therefore when the PV system contains an AC load, a DC/AC conversion is required. This is the reason why this section presents the inverter model. The inverter is characterized by a power dependent efficiency ( $\eta_{Inv}$ ). The role of the inverter is to keep on the AC side the voltage constant at the rated voltage 230 V and to convert the input power into the output power with the best possible efficiency. The inverter model is [RETScreen, 2003/ Manwell, 1998]:

$$E_{Inv} = E_{Array} \times \eta_{Inv} \quad (4.31)$$

Where

- $E_{Inv}$  = Energy output from inverter, kWh
- $E_{Array}$  = Energy generated by PV array, kWh
- $\eta_{Inv}$  = Inverter efficiency, %

### **Charge controller**

This section presents the modeling of the controller of a PV system. The charge controller is used to manage the energy flow to PV system, batteries and loads by collecting information on the battery voltage and knowing the maximum and minimum values acceptance for the battery voltage. The modeling of the controller is presented below [RETScreen, 2003/ Manwell, 1998]:

$$E_{out} = E_{in} \cdot \eta_{Chg} \quad (4.32)$$

Where:

- $E_{out}$  = Energy output from charge controller, kWh
- $E_{in}$  = Energy input to charge controller, kWh
- $\eta_{Chg}$  = Efficiency of charge controller

### **Battery**

An important element of a PV system is the battery. The battery is necessary in such a system because of the fluctuating nature of the output delivered by the PV arrays. Thus, during the hours of sunshine, the PV system is directly feeding the load, the excess electrical energy being stored in the battery. During the night, or during a

period of low solar irradiation, energy is supplied to the load from the battery. The steps of battery model as used in the RES are presented as followed [RETScreen, 2003/ Manwell, 1998]:

#### *Minimum Energy Left in Battery*

$$E_{BattMin} = (1 - DOD_{max}) \times BattCap \quad (4.33)$$

Where:

$E_{BattMin}$  = minimum energy left in battery, kWh

$DOD_{max}$  = maximum depth of discharge of battery, %

$BattCap$  = battery capacity, kWh

#### *Maximum Discharge Energy of Battery*

$$E_{MaxDis} = (E_{Batt} - E_{BattMin}) \times (\eta_{Batt} \times \eta_{BattInv}) \quad (4.34)$$

Where:

$E_{MaxDis}$  = Maximum discharge energy of battery, kWh

$E_{Batt}$  = Energy of battery, kWh

$\eta_{Batt}$  = Battery efficiency, %

$\eta_{BattInv}$  = Battery inverter efficiency, %

#### *Discharge Energy of Battery*

$$E_{BattDis} = |E_{Load} - E_{Inv}| \quad (4.35)$$

Where:

$E_{BattDis}$  = Discharge energy of battery, kWh

$E_{Load}$  = Required energy for load, kWh

#### *Energy Used for Charge the Battery*

$$E_{ChgBatt} = (E_{Line} \times \eta_{BattInv}) \times \eta_{Batt} \quad (4.36)$$

Where:

$E_{ChgBatt}$  = Energy used for charge battery, kWh

$E_{Line}$  = Energy in line after supplied to load, kWh

### *Energy of Battery After charge*

$$E_{BattNew(C)} = E_{BattOld(C)} + E_{ChgBatt} \quad (4.37)$$

Where:

$E_{BattNew(C)}$  = Energy of battery after charge, kWh

$E_{BattOld(C)}$  = Energy of battery before charge, kWh

### *Energy of Battery after Discharge*

$$E_{BattNew(D)} = E_{BattOld(D)} - \left( \frac{E_{BattDis}}{\eta_{BattInv} \times \eta_{Batt}} \right) \quad (4.38)$$

Where:

$E_{BattNew(D)}$  = Energy of battery after discharge, kWh

$E_{BattOld(D)}$  = Energy of battery before discharge, kWh

### *Battery State of Charge*

$$SOC = \frac{E_{Batt}}{BattCap} \quad (4.39)$$

Where:

SOC = Battery State of Charge, %

$E_{Batt}$  = energy of battery, kWh

$BattCap$  = battery capacity, kWh

### ***Diesel generator and surplus energy***

Conventional generators are normally diesel engines directly coupled to generators. The frequency of the AC power is maintained by a governor on one of the engines. The governor adjusts the flow of fuel to the engine to keep the engine and generator

speed essentially constant. The grid frequency is directly related to the speed of the generator, and is, therefore, maintained at the desired level. The RES diesel generator model uses the net loads energy demand to calculate energy supplied by the diesel generator for a base case and additional system configurations. The energy flow model of the diesel generator as used in RES is [RETScreen, 2003/ Manwell, 1998]:

#### *Energy Generated by Diesel Generator*

$$E_{Diesel} = DieselCap \times \eta_{Diesel} \quad (4.40)$$

Where:

$E_{Diesel}$  = Energy Generated by Diesel Generator, kWh

$DieselCap$  = Diesel generator capacity, kWh

$\eta_{Diesel}$  = Diesel generator efficiency (20 - 40), %

#### *Surplus Energy*

$$E_{Surplus} = E_{Batt} - BattCap \quad (4.41)$$

Where:

$E_{Surplus}$  = Surplus energy, kWh

$E_{Batt}$  = Energy of battery, kWh

$BattCap$  = Battery capacity, kWh

### **4.2.3 Economical model**

The basis of most engineering decisions is economics. Designing and building a device or system that functions properly is only part of the engineer's task. The device or system must, in addition, be economic, which means that the investment must show an adequate return.

The economics section of the RES model is based on the use of conventional life cycle costing economics. That is, the RES economic routine performs a first level economic evaluation of a PV system. This includes yearly cash flows, the present



value of system costs, incomes and levelized annual costs. In addition, the analysis has been designed to allow for a side-by-side comparison of the economics of a hybrid power system with those of a diesel-only powered system and grid extension. Another aspect of RES economics is the ability to examine the potential economic advantage (or disadvantage) of adding renewable energy sources to a pre-existing diesel-powered system. It is assumed that the user will use the RES economics package to obtain a desired system design and then will perform an independent economic analysis using the methods and software of his or her choice.

### **Total Capital Cost**

As detailed below, the cash flow analysis produces year-by-year detailed figures for project incomes and disbursements. The disbursements are separated into the following categories: installed capital costs/annuity payments, fuel costs, operation and maintenance expenses, and equipment replacement costs.

Installed Capital Cost is the initial venture capital for a PV system including equipment costs, installation expenses, tariffs, shipping costs, and possibly the cost of extending a distribution network from the PV power system to the consumer loads. While every effort has been made to identify the major capital costs, RES uses a “balance of system” term,  $C_{Cap,BOS}$ , in order to account for any capital costs which are unique to the user's application. Therefore the system installed capital cost,  $C_{Cap,tot}$  is given by [Stoecker, 1989/Manwell, 1998/Yaron, 1994]:

$$C_{Cap,tot} = C_{Cap,PV} + C_{Cap,Inv} + C_{Cap,Diesel} + C_{Cap,Batt} + C_{Cap,BOS} + C_{Cap,Inst} + C_{Cap,Oth} \quad (4.42)$$

Where:

$$C_{Cap,Inst} = C_{Inst,PV} + C_{Inst,Batt} + C_{Inst,Inv} + C_{Inst,BattInv} + C_{Inst,Batt} + C_{Inst,Diesel} \quad (4.43)$$

$$C_{Cap,Inv} = C_{Cap,Inv} + C_{Cap,BattInv} + C_{Cap,Chg} \quad (4.44)$$

$$C_{Cap,Oth} = C_{Ship} + C_{Oth} \quad (4.45)$$

Where:

$C_{Cap,PV}$  = Capital cost of PV array, Currency

$C_{Cap,Inv}$  = Capital cost of inverter, Currency

- $C_{Cap,Diesel}$  = Capital cost of diesel generator, Currency  
 $C_{Cap,Batt}$  = Capital cost of battery storage, Currency  
 $C_{Cap,Inst}$  = Installation cost, Currency  
 $C_{Cap,Oth}$  = Capital cost of other, Currency  
 $C_{Ship}$  = Shipping cost, Currency

### **Annual Cost**

These consist of regular maintenance costs, fuel cost (diesel generator) over the years. The actual data of annual maintenance and fuel cost on systems installed is difference for each location. Therefore the system annual cost model of RES,  $C_{ann,tot}$  is given by [Manwell, 1998/Yaron, 1994]:

$$C_{ann,tot} = C_{ann,PV} + C_{ann,Batt} + C_{ann,Inv} + C_{ann,Diesel} + C_{ann,Sys} + C_{ann,Fuel} + C_{ann,Oth} \quad (4.46)$$

Where:

$$C_{ann,Fuel} = C_{Fuel/L} \times FuelConsump \times Hr_{Diesel} \quad (4.47)$$

$$C_{ann,Inv} = C_{ann,Inv} + C_{ann,BattInv} + C_{ann,Chg} \quad (4.48)$$

Where  $C_{ann,Fuel}$  is annual cost of fuel,  $FuelConsump$  is diesel engine fuel consumption rate and  $Hr_{Diesel}$  is hour operation of the diesel generator.

### **Replacement Cost**

Replacement costs are slightly more complex in that they involve regular cash payments but are not truly annual. The main components of the system have to replace during the life time of the system. In order to convert replacements costs into annual ones therefore the replacement annual cost ( $C_{Repl}$ ) equation is given by [Manwell, 1998/Yaron, 1994]:

$$C_{Repl,Diesel} = C_{OH} \times (PWF, i, n) \quad (4.49)$$

$$C_{Repl,Batt} = C_{Batt} \times (PWF, i, n) \quad (4.50)$$

$$C_{Repl,Inv} = (C_{Inv} + C_{BattInv} + C_{Chg}) \times (PWF, i, n) \quad (4.51)$$

$$C_{Repl,Oth} = C_{Oth} \times (PWF, i, n) \quad (4.52)$$

$$C_{Repl,tot} = C_{Repl,Diesel} + C_{Repl,Batt} + C_{Repl,Inv} + C_{Repl,Oth} \quad (4.53)$$

Where: 
$$PWF = F \left[ \frac{1}{(1+i)^n} \right] \quad (4.54)$$

$$i = \frac{i_f - f}{1+f} \quad (4.55)$$

Where:

- $PWF$  = Present-worth factor
- $F$  = Future money, Currency
- $n$  = Component Lifetime, Year
- $i$  = Actual interest rate, % per year
- $i_f$  = Interest rate, % per year
- $f$  = inflation rate, % per year

### **Present value of the annualized cost and salvage value**

The series-present-worth factor (SPWF) translates the value of a series of uniform amounts  $C$  into the present worth. The present worth of the series can be found by applying the  $PWF$  to each of the  $C$  amount [Manwell, 1998/Yaron, 1994]:

$$C_{ann,PW} = (C_{ann,tot} \times (SPWF, i, n)) \quad (4.56)$$

$$SPWF = A \left[ \frac{(1+i)^n - 1}{i(1+i)^n} \right] \quad (4.57)$$

$$C_{Sal,PW} = C_{Sal} \times (PWF, i, n) \quad (4.58)$$

Where  $A$  is annual money (Currency),  $n$  is system lifetime (Years) and  $C_{sal}$  is salvage value.

### **Life Cycle Cost (LCC)**

The methodology used to define the LCC is a multi-step process, as present above. This process requires sets of data from fielded systems and the development of a sophisticated database tool for analysis of the data. LCC determine which power supply systems can be cost-competitive with other energy options [Manwell, 1998/Yaron, 1994].

$$LCC = C_{Cap,tot} + C_{ann,PW} + C_{Repl,PW} - C_{Sal,PW} \quad (4.59)$$

### **Net Present Value (NPV)**

In the RES economics, the net present value of the project is determined from summing the annual cost, replacement cost and the initial capital expenses [Stoecker, 1989/Manwell, 1998/Yaron, 1994].

$$NPV = (-C_{Cap,tot}) + C_{ann,PW} + C_{Repl,PW} \quad (4.60)$$

### **Levelized Cost of Energy (COE)**

Another levelized calculation concerns the cost of energy, COE. The total levelized cost of energy is given by [Manwell, 1998/Yaron, 1994]:

$$COE = \frac{LCC}{(E_{Prod} \times SysLife)} \quad (4.61)$$

Where  $E_{Prod}$  is energy that system generated in one year (kWh/y) and  $SysLife$  is system lifetime (years).

## **4.3 Software testing**

This section presents two example of validation against monitored data from a real site. The example is a system test and compares the predicted energy production of a PVHS at SERT and PVS at Chiangria Province, Thailand the RES model against results of monthly average data from the sites.

### **4.3.1 Validation of RES PVHS model compared with SERT PVHS monitored**

In this section the predictions of the RES PVHS model are tested against monitored data from real sites. The system configurations of PVHS already mention in **Chapter 3**. Titled solar radiation is shown in **Table 4-3**.

**Table 4-3:** Comparison of RES PVHS calculation and SERT PVHS monitored

Month	Tilted Solar Radiation (kWh/m <sup>2</sup> .d)		% error	PV Energy Production (kWh)		% error	Genset Energy Production (kWh)		% error
	Monitored	Simulation		Monitored	Simulation		Monitored	Simulation	
Jan	4.65	5.18	-11	267	275	-3	19	21	-12
Feb	5.34	5.61	-5	257	282	-10	15	16	-5
Mar	5.47	5.73	-5	284	296	-4	17	18	-9
Apr	5.91	6.00	-2	283	310	-10	14	15	-9
May	5.42	6.01	-11	287	312	-9	17	19	-11
Jun	5.31	5.19	2	279	274	2	20	22	-10
Jul	5.06	4.89	3	261	257	2	22	25	-13
Aug	5.33	5.31	0	283	281	1	19	20	-8
Sep	5.48	4.89	11	293	251	14	22	23	-5
Oct	5.73	5.27	8	305	270	12	20	22	-12
Nov	5.37	4.82	10	281	250	11	21	23	-8
Dec	5.33	4.98	7	283	261	8	23	24	-7
<b>Year</b>	<b>5.37</b>	<b>5.32</b>	<b>1</b>	<b>3,362</b>	<b>3,319</b>	<b>1</b>	<b>227</b>	<b>248</b>	<b>-9</b>

For RES, monthly results were obtained by exporting hourly simulation data and performing a summation. The results of the comparison are summarized in **Table 4-3**. On an average yearly basis RES predicts slightly less tilted solar radiation than monitored data (5.37 vs. 5.32 kWh/m<sup>2</sup>.d, or a difference of 1%). Part of this difference (around 1%) is attributable to differences in the calculations of PV energy production, as shown in the table. Contributions from the genset, reported in table as yearly energy production, differ around 9% (227 vs. 248 kWh). Overall, these differences are insignificant and illustrate the adequacy of the RES PVHS model for feasibility studies. Graphical comparisons of the results are present in **Figure 4-2** to **Figure 4.4**.

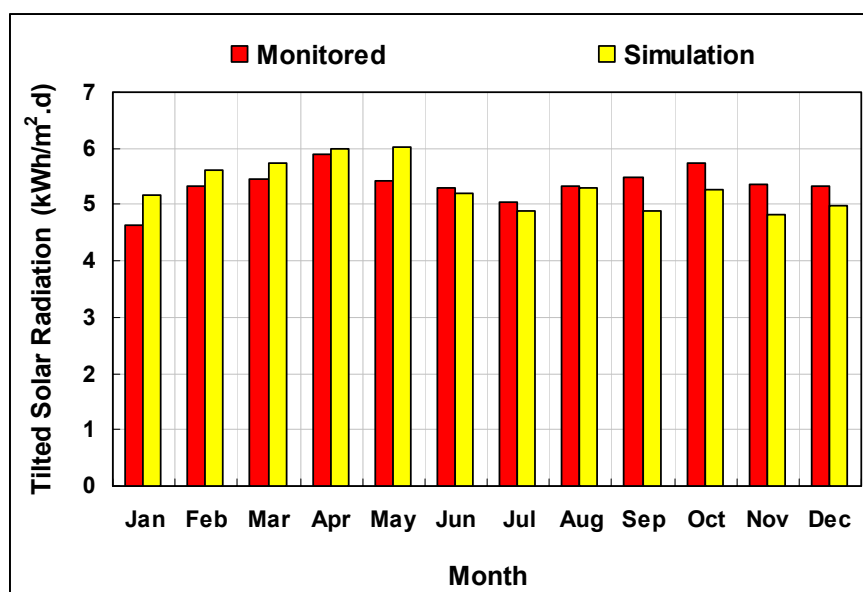
**Figure 4-2:** Comparison of titled solar radiation calculated by RES and monitored

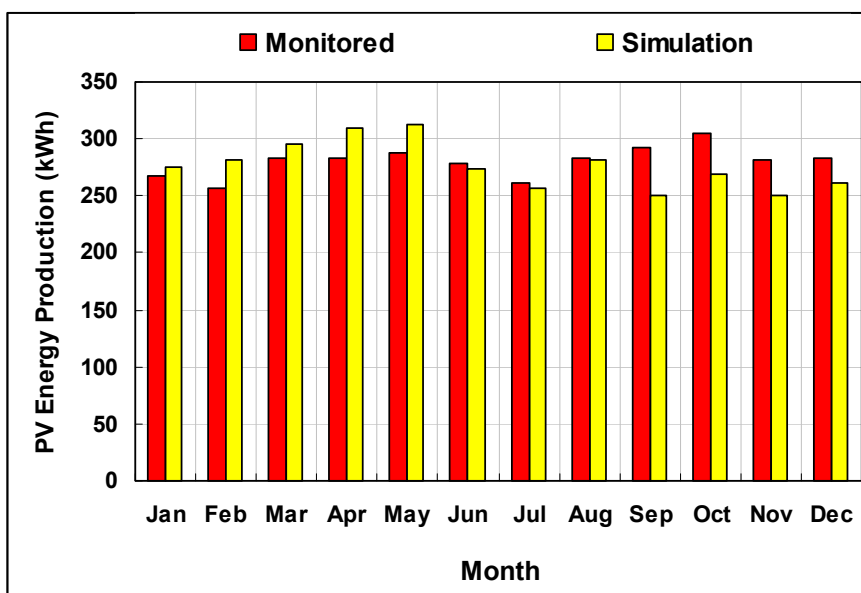

Figure 4-3: Comparison of PV energy production calculated by RES and monitored

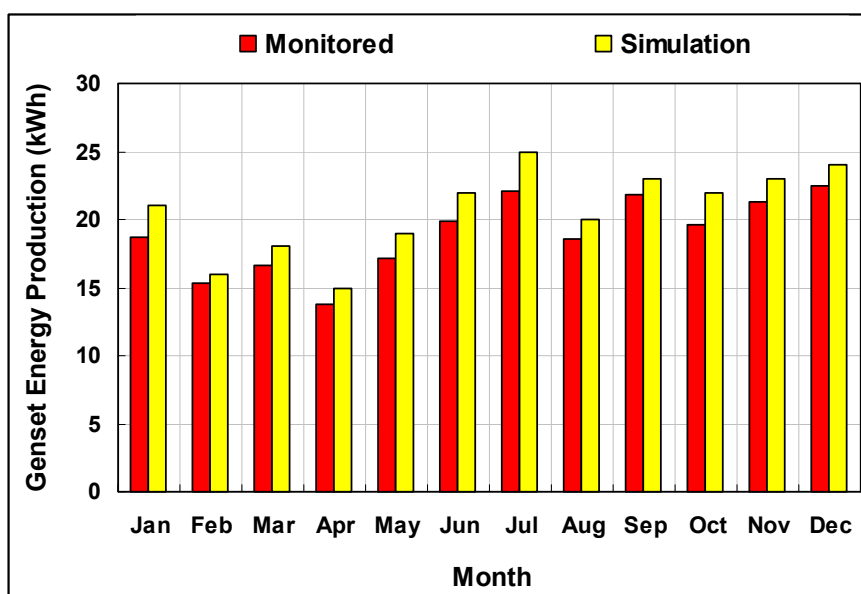
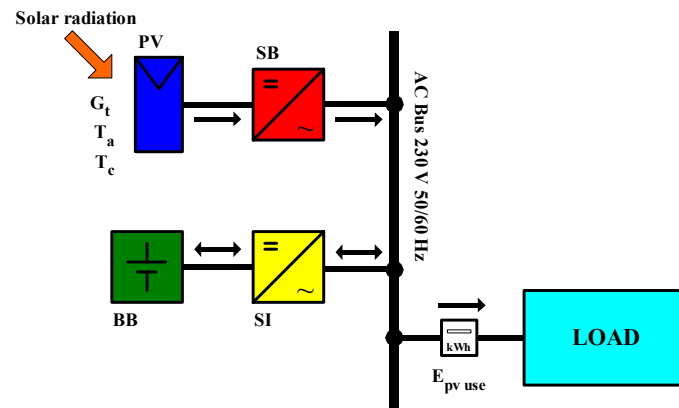

Figure 4-4: Comparison of genset energy production calculated by RES and monitored

#### 4.3.2 Validation of RES PVS model compared with Chiangria PVS monitored

In this section the predictions of the RES PVS model are tested against monitored data from real sites. The PVS located Northern of Thailand in Chiangria Province (latitude 20 °N). Titled solar radiation is shown in **Table 4-4**.



PV: PV generator "Siemens SP 75", 75W @ 40 modules  
 BB: Battery bank "SunGel 2SG650", 60V @ 650 Ah  
 SB: Grid connected inverter "SMA Sunny Boy", 3.0 kW  
 SI: Battery inverter "SMA Sunny Island", 3.3 kW

**Figure 4-5:** PV system at Chiangria Province, Thailand

The system specifications consisting of (**Figure 4.5**): 3 kWp PV generators, the array is titled at  $20^\circ$  facing south. 3.0 kW Sunny Boy grid inverter 90% average efficiency, 3.3 kW Sunny Island battery inverter (bi-directional inverter) 90% average efficiency and 39 kWh SunGel battery storage with 80% round trip efficiency and 40% maximum depth of discharge (DOD). The overhead distribution line is 420 m service line. Total energy demand is approximately 8.9 kWh/d.

**Table 4-4:** Comparison of RES PVS calculation and Chiangria PVS monitored

Month	Tilted Solar Radiation (kWh/m <sup>2</sup> .d)		% error	PV Energy Production (kWh)		% error
	Monitored	Simulation		Monitored	Simulation	
Jan	4.79	4.54	5	432	398	8
Feb	5.52	4.97	10	453	411	9
Mar	5.79	5.23	10	484	472	3
Apr	6.01	5.71	5	495	472	5
May	5.98	5.91	1	491	471	4
Jun	5.20	5.11	2	443	414	7
Jul	4.91	4.64	5	435	405	7
Aug	5.30	5.11	4	450	437	3
Sep	4.91	4.59	7	433	405	6
Oct	5.36	4.68	13	449	443	1
Nov	4.96	4.13	17	436	398	9
Dec	4.73	4.23	11	428	394	8
<b>Year</b>	<b>5.29</b>	<b>4.90</b>	<b>7</b>	<b>5,429</b>	<b>5,121</b>	<b>6</b>

The results of the comparison are summarized in **Table 4-4**. On an average yearly basis RES predicts slightly less titled solar radiation than monitored data (5.29 vs. 4.90 kWh/m<sup>2</sup>.d, or a difference of 7%). Part of this difference (around 6%) is

attributable to differences in the calculations of yearly PV energy production, as shown in the table (5,429 vs. 5,121 kWh). Overall, these differences are insignificant and illustrate the adequacy of the RES PV model for feasibility studies. Graphical comparisons of the results are present in **Figure 4-6** to **Figure 4.7**.

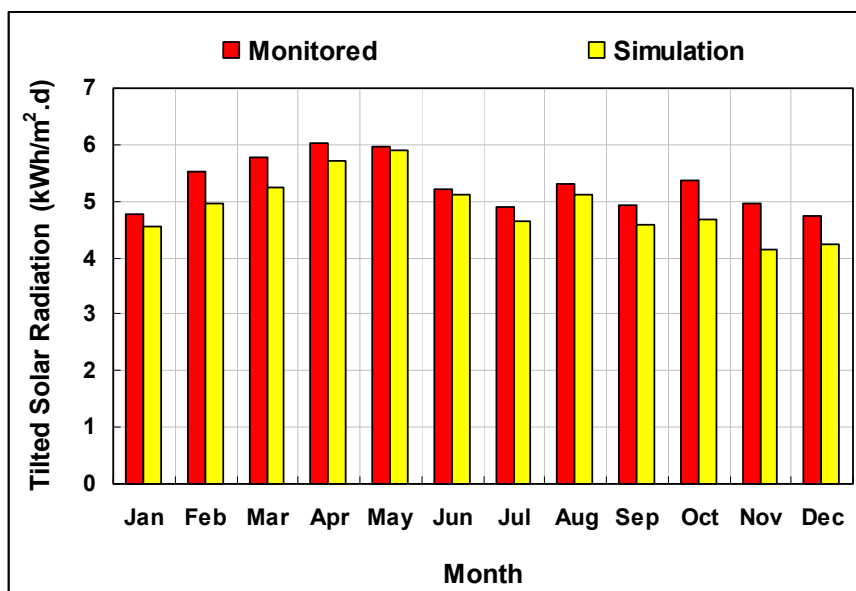

**Figure 4-6:** Comparison of titled solar radiation calculated by RES PVS and monitored

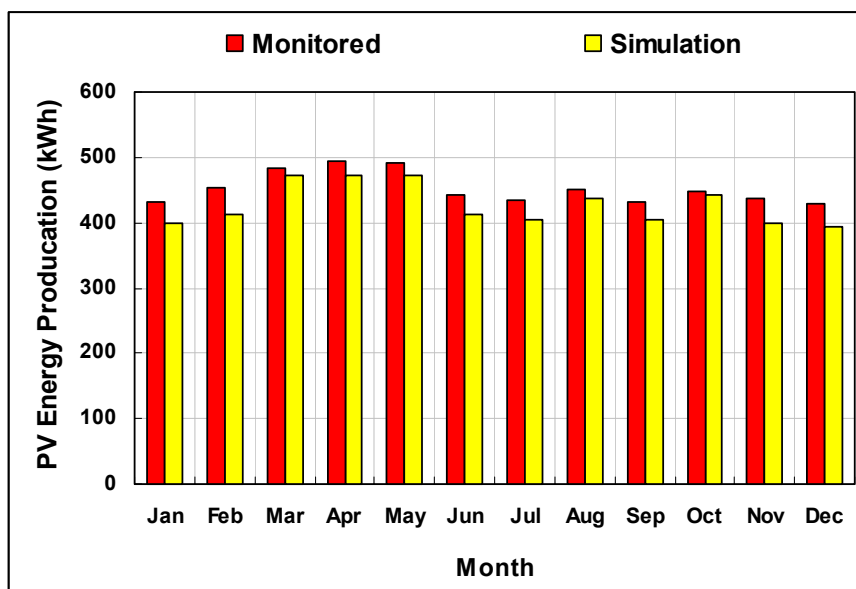

**Figure 4-7:** Comparison of PV energy production calculated by RES PVS and monitored



#### **4.4 Summary**

In this section the algorithms used by the RES have been shown detail. The titled irradiance calculation algorithms, the PV array model and the economic model are common to all applications. The titled irradiance calculation uses an hourly model. The PV array model takes into account changes in array performance induced by ambient temperature. The PVHS, PVS, SHS, BCS, DGS and GE model are relative energy flow models based on assumed average efficiencies and are relative economic models based on life cycle cost analysis. The Renewable Energy System model is more complex and allows for distinction between similar and custom difference loads profile which may have an influence on the amount of energy going through the battery. The validations of RES illustrate the adequacy for Rural Electrification System feasibility studies.

## 5 CASE STUDY OF RURAL ELECTRIFICATION IN MEKONG COUNTRIES

### 5.1 Introduction

The case study of rural electrification in Mekong Countries presents how an energy planner/engineer can make a quick pre-feasibility study on remote area power supply using the software RES (**Chapter 4**). The system performance, economic performance and sensitivity analysis are presented of three different locations from selected Mekong Countries. **In this research the PV system analysis limited at 10 kWp cause from not available actual data of higher installed capacity for validation of study results.**

Ban Pang Praratchatang (BPP) in Thailand, Samaki in Cambodia and Thapene in Lao PDR have been selected as cases for this pre-feasibility analysis, because relevant literature for pre-electrification with PV systems is available. BPP was selected because there has been a development project with a PV system and monitoring data is available from this system under the framework of MGCT project [Ketjoy, 2004]. Samaki was selected because there has been a development project with a PV system and monitoring data is available from this system under the Ministry of Industry, Mines and Energy (MIME) project [Li, 2002] and Thapene was chosen because there has available data from SERT and CORE.

### 5.2 Case of Ban Pang Praratchatang, Thailand

#### 5.2.1 Description of Ban Pang Praratchatang

##### *Location and renewable energy resources*

Ban Pang Praratchatang is a hill-tribe village as part of Doi Tung Development Royal Project in the Mae Fah Luang district of the Chiang Rai province located in the northern part of Thailand (**Figure 5-1**). This area encompasses a total of 27 village communities of different ethnic minority groups and hill-tribes; Akha, Lahu, Tai Yai and ethnic Chinese immigrants continue to perform ancient rituals and celebrate traditional folk festivals throughout the year. With many aspects of their culture and way of life well preserved, these ethnic communities are of immense ethnographic interest and importance to the study and preservation of the rich cultural heritage of Asia. Access to education, vocational training and a range of employment

opportunities this enables ethnic minority groups in the project area to preserve their heritage whilst progressing into modernity [Doi Tung].



[Source: [www.un.org/Depts/Cartographic/map/](http://www.un.org/Depts/Cartographic/map/)]

**Figure 5-1:** Map of Thailand and location of BPP in Chiang Rai province

They earn a steady income and have become self-sufficient. As a result, there has been a substantial improvement in their standard of living and quality of life. The village communities have managed to achieve a level of sustainable development that fosters the harmonious co-existence of indigenous culture and the surrounding natural environment.

Renewable energy resources in BPP have been analyzed as to solar irradiation and wind speeds (**Table 5-1**). Irradiation is quite high with an average value of 4.91 kWh/m<sup>2</sup>.d [DEDP, 2000]. In order to run wind turbines efficiently economically, the average wind speed should exceed 6 m/s. Wind speeds at BPP reach an average of 2.6 m/s [DEDP, 2001] and are thus too low for installing wind turbines. As a result, solar irradiation is considered the only renewable energy source.

**Table 5-1:** Renewable energy resource in BPP

Irradiation in BPP (kWh/m <sup>2</sup> .d)												
Jan	Feb	Mar	Apr	May	Jun	Jul	Aug	Sep	Oct	Nov	Dec	Ave
4.24	4.79	5.25	5.86	6.19	5.46	4.85	5.46	4.58	4.58	4.32	4.18	4.91
Wind speeds (m/s)												
Jan	Feb	Mar	Apr	May	Jun	Jul	Aug	Sep	Oct	Nov	Dec	Ave
2.8	2.6	3.6	2.8	3.6	3.0	2.5	2.0	1.8	1.5	2.0	2.5	2.6

### Load demand of BPP

The BPP case study is especially suitable to show the trend of electricity demand in small hill-tribe villages with the potential to expand to big village in the future. Present and future electricity demands have been observed by SERT staff [Rakwichian et al, 2004]. For the evaluation of RES, only the present electricity demand will be taken into consideration.

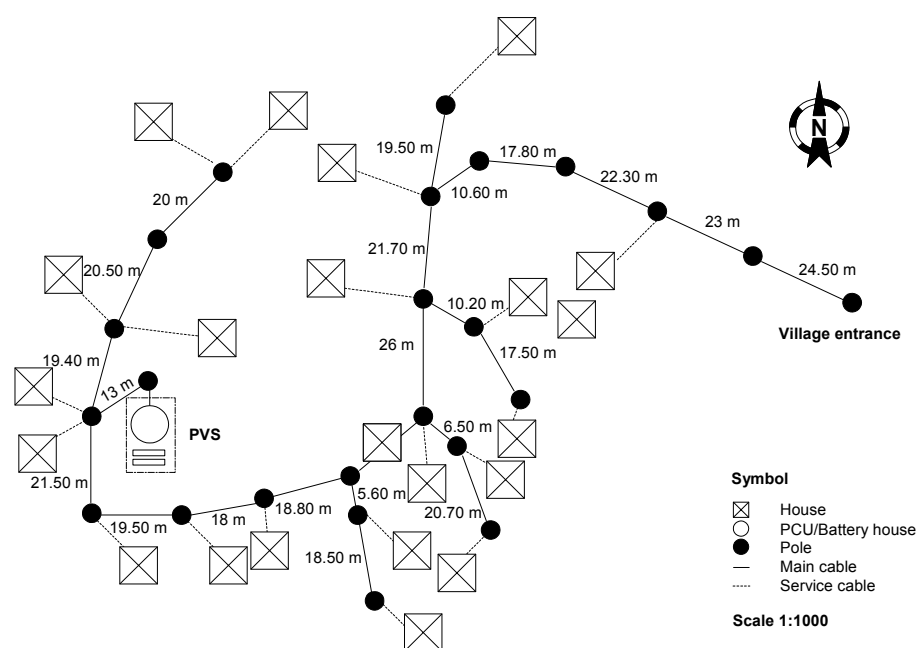
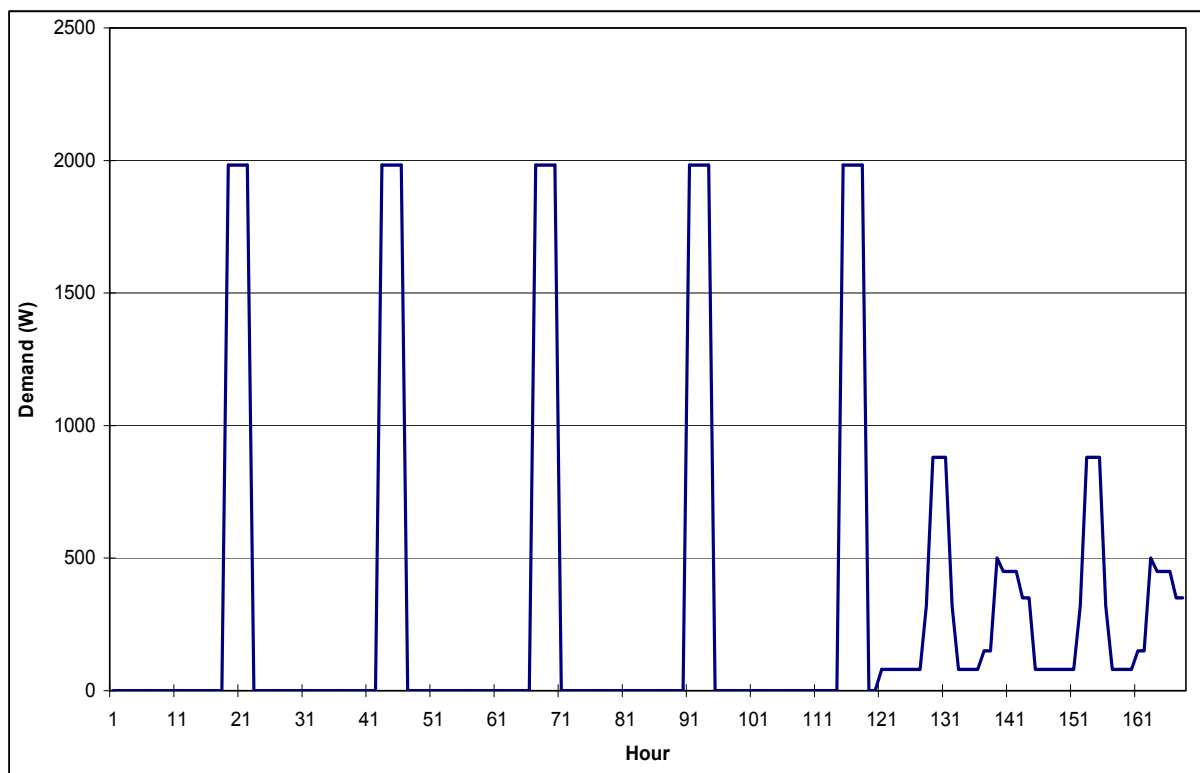

**Figure 5-2:** Map of BPP village [Rakwichian et al, 2004]

BPP has about 22 households with 140 inhabitants (**Figure 5-2**). Income currently comes from work as employees under the Doi Tung Development Royal Project. In 1999, the village was electrified by the Public Work Division (PWD) with 5 strings of BCS with a total installed capacity of 750 Wp (150 Wp/string). In 2002, PWD installed 3,000 Wp PVS [Rakwichian et al, 2004].

**Table 5-2:** Load demand and duration time of used in BPP during Monday - Friday

Appliance	Power (W)	Quantity (Unit)	Total power (W)	Duration (Hr)	Consumption (Wh/d)
Fluorescent lamp	36	2	72	18.00 - 22.00	288
Fluorescent lamp	18	40	720	18.00 - 22.00	2,880
Colour TV 14"	60	5	300	18.00 - 22.00	1,200
Colour TV 20"	82	2	164	18.00 - 22.00	656
B & W 14"	50	1	50	18.00 - 22.00	200
Refrigerator	100	1	100	18.00 - 22.00	400
Tap player	120	3	360	18.00 - 22.00	1,440
VCD player	48	2	96	18.00 - 22.00	384
Fan	40	3	120	18.00 - 22.00	480
<b>Total</b>			<b>1,982</b>	<b>18.00 - 22.00</b>	<b>7,928</b>



**Figure 5-3:** Weekly demand profile of BPP village generate by RES [Rakwichian et al, 2004]

**Table 5-2** shows present loads in BPP. The BCS was not taken into account, because it was rarely used after the PVS was installed. There is a non-continuous load, the peak load of 1,982 W occurs in the evening 4 hours/d. **Figure 5-3** shows the load profile in hourly steps for the weekly. The peak load of 1.9 kW occurs in the evening hours. The villagers have an agreement together for the period of electricity usage. The village leader will turn off the supply switch during the day time and turn it on again on 18.00. An average electricity demand is calculated at 7,928 Wh/d [Rakwichian et al, 2004].

### 5.2.2 Input of RES

The main configuration to be investigated in this case is the typical PVHS. The technical and economic parameters of the simulated models of each component are summarized as follows:

- **PV generator**

*Characteristics:* SIEMENS modules SP75 with module peak power = 75 (W),  
 $I_{SC} = 4.8$  (A),  $V_{OC} = 21.7$  (V),  $V_{MPP} = 17.0$  (V),  $I_{MPP} = 4.4$  (A) and  
 $\beta = -0.077$  V/°C (75 W x 26 module)

*Orientation:* South faced modules with a tilt angle of 20°

*Costs:* Investment cost is 3,000 €/kWp, O&M is 0.05 %/year of investment  
 Cost, operating lifetime 20 years

- **Diesel generator**

*Characteristics:* 5 kW, the lifetime is assumed to be 30,000 hours

*Costs:* For 5, 25, 50, 75 and 100 kW rated powers investment costs are equal  
 to 533, 325, 220, 183 and 160 €/kW respectively,  
 Overhaul 15,000 hours, overhaul cost 20% of investment  
 Maintenance cost 3%/year of investment  
 Diesel fuel cost at BPP is 0.4 €/Lit

- **Battery storage**

*Characteristics:* Exide OPzV 305 batteries (20 kWh),  $C_{10} = 216$  Ah, Volt/cell= 2 (V),  
 ageing model parameters are: initial capacity ( $C_0$ ) = 100% of the  
 nominal, DOD = 70%, and the end of lifetime is at 80% of the  
 nominal capacity and lifetime is taken to be 8 years

*Costs:* Investment costs = 160 €/kWh, O&M=0.05%/year of investment

- **Power conditioning**

*Characteristics:* PV inverter, type Sunny Boy with MPP tracking  
 Bi-directional battery converter, type Sunny Island  
 Lifetime is taken to be 12 years

*Costs:* Investment cost of the PV-inverter and battery converter are taken to be 720 €/kW and 1155 €/kW respectively  
 O&M is 1.0%/year of investment

- **Balance of system**

*Characteristics:* AC power-line of 220 V (420 m), inter-bus for communication and control unit and control room

*Costs:* investment costs of 15% of the total system investment.  
 Project lifetime of 20 years, discount rate of 5 - 10%

### 5.2.3 System performance results of PVHS at Ban Pang Praratchatan

#### *Energy consumption*

The yearly energy demand of this system is 2,798.2 kWh, average daily energy demand is 7.7 kWh and the energy produced by diesel-generator over the year is 45.2 kWh (**Figure 5-4**).

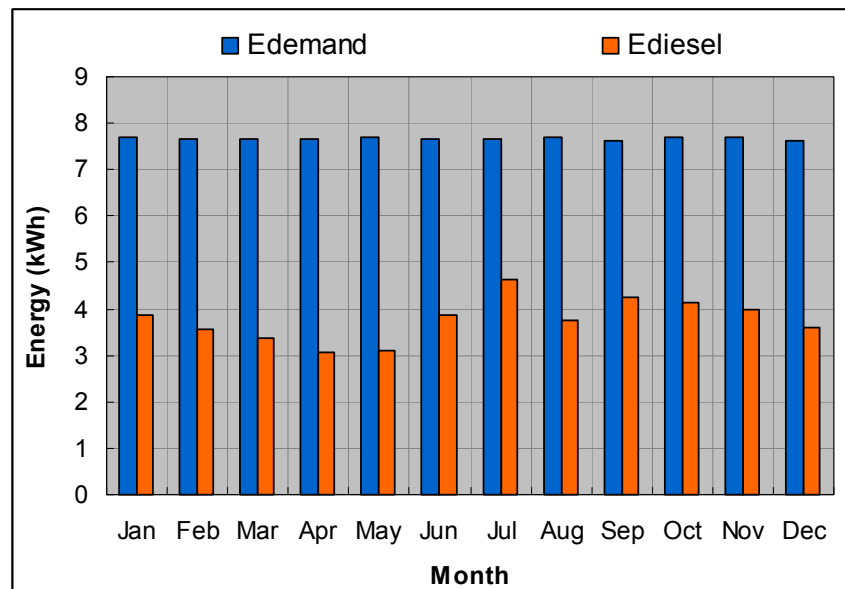

**Figure 5-4:** Correlation of daily energy demand and energy produced by diesel-generator

### Balance of energy

**Figure 5-5** presents, as a brief overview, the simulated energy balance of the PVHS at BPP with the RES. The daily average energy produced by PV is 9.4 kWh, the daily average energy supplied by the diesel generator is 3.77 kWh. Daily average of net energy use from PV is 5.7 kWh and no surplus energy in the system. The data show 64% of that the energy produced by PV can be used.

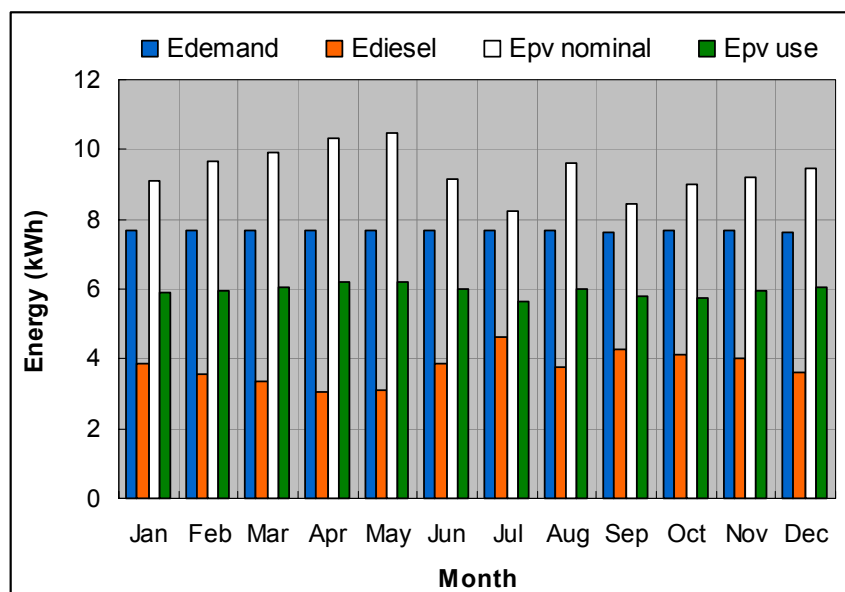

**Figure 5-5:** Energy balance of the PVHS at BPP

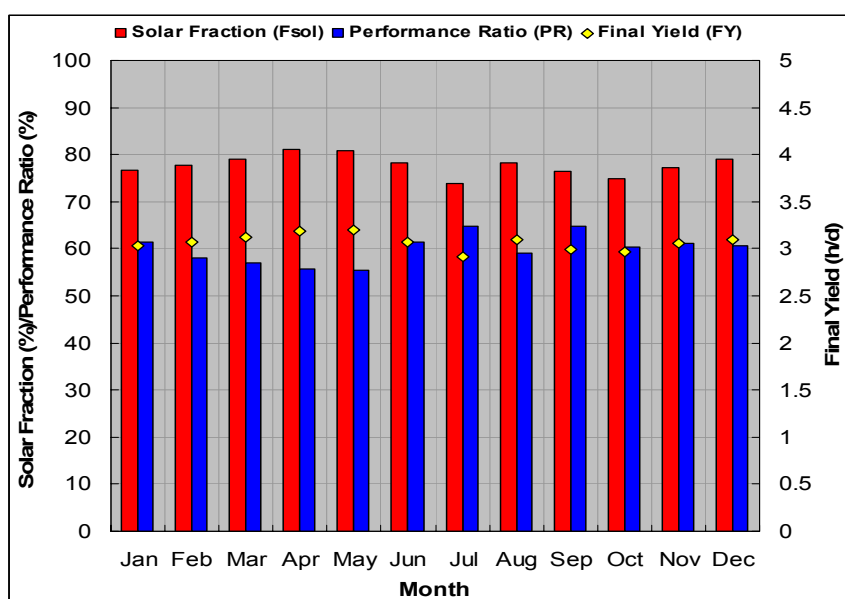
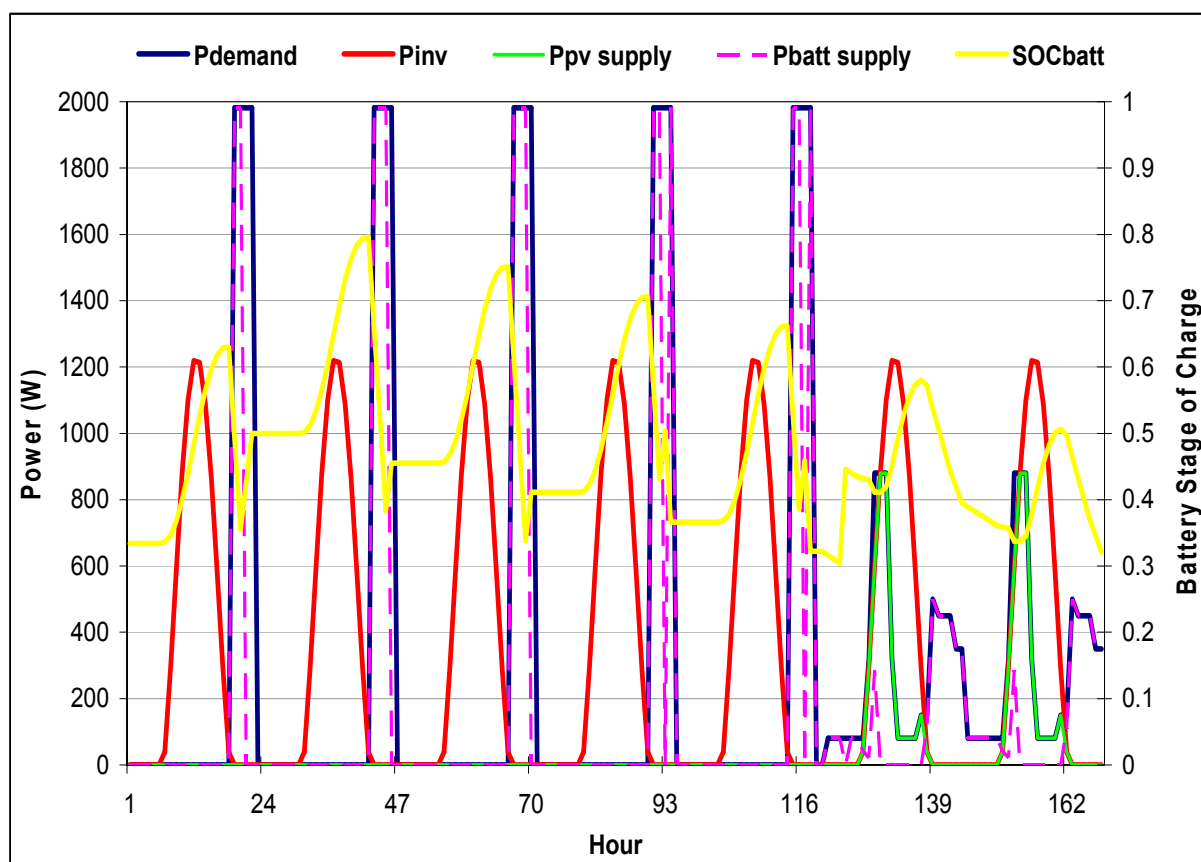

**Figure 5-6:** System performance of the PVHS at BPP



### System performance

**Figure 5-6** presents the PVHS performance; the  $PR$  of 60% indicates that on an annual base under the prevailing conditions 40% of the nominal energy is not available for load supply due to losses in reflection, higher module temperature, cable and conversion losses, even if the station is continuously used daily. The annual average  $F_{sol}$  of the system is 78% and  $FY$  is 3.1 h/d. This potential of the system is comparably high to the potential range of PV hybrid system. One reason is the high uniformity of the irradiation profile throughout the year and the good match between production and consumption.



**Figure 5-7:** Selected weekly power supply by PV, battery and battery SOC of PVHS at BPP

**Figure 5-7** shows the distribution of weekly system availability of the PVHS at BPP. The demand load supplied directly by PV ( $P_{pv}$  supply) is about 900 W; the remaining load is supplied by battery. The frequency distribution of the Battery Stage of Charge (SOC) range in the considered evaluation period moves between 0.30 – 0.80. The SOC indicates how often the battery is found in a charge state.

## 5.2.4 Economics performance results of PVHS at Ban Pang Praratchatan

In this section, the economic performance study results of the PVHS at BPP are presented. The results presented are based on LCC and COE. The difference assumptions of the economic parameter are considered. **Table 5-3** shows the sums up the cases of different of an assuming (case 1-6 is PVHS, case 7 is PVS, case 8 is DGS and case 9 is GE).

**Table 5-3:** Comparison of the difference assumption of the PVHS economics study and PVS, DGS and GE

Description	Case1	Case2	Case3	Case4	Case5	Case6	Case7	Case8	Case9
PV investment cost (€/kW)	3,000	3,000	3,000	2,600	2,600	2,600	3,000	-	-
Diesel generator (€/kW)	400	400	400	400	400	400	-	400	-
Battery storage (€/kWh)	160	160	160	140	140	140	160	-	-
Power conditioning (€/kW)	1,007.2	1,007.2	1,007.2	732	732	732	1,007.2	-	-
Grid extension (€/km)	-	-	-	-	-	-	-	-	14,000
Transformer (30 kVA)	-	-	-	-	-	-	-	-	600
BOS (%of investment cost)	15	15	15	17	17	17	10	50	5
O&M (%of investment cost)	16	16	16	19	19	19	4	196	3
Replacement cost (%of investment cost)	30	30	30	27	27	27	34	20	5
Interest rate (%)	5	7.5	10	5	7.5	10	5	5	5
Inflation rate (%)	0.5	0.5	0.5	0.5	0.5	0.5	0.5	0.5	0.5
Initial investment cost (€)	18,886	18,886	18,886	16,330	16,330	16,330	15,586	4,000	37,600
LCC (€)	26,150	24,924	23,914	22,661	21,595	20,722	21,292	13,040	36,300
COE (€/kWh)	0.60	0.57	0.55	0.52	0.49	0.47	0.61	0.74	0.65

Note: 1 € = 50 Baht / Import tax = 30% for battery and inverter/ Vat 7%

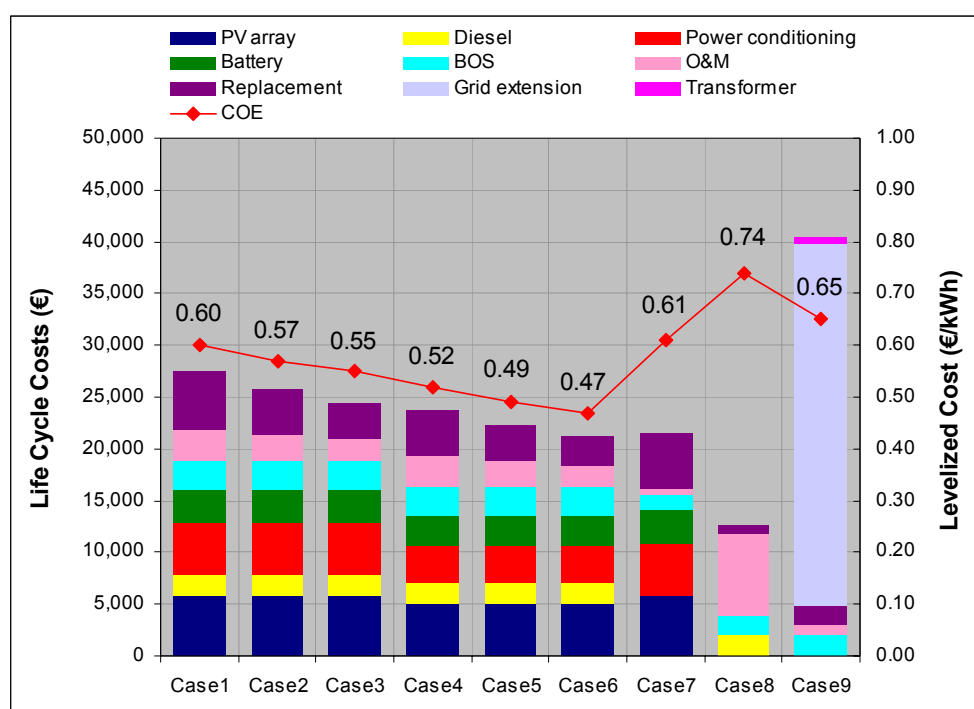

**Figure 5-8:** LCC analysis of different assumption

An analysis of the LCC of the different system assumption is explained in **Figure 5-8**. This figure shows that the LCC of case 1 – 3 the PV array and power conditioning represents a basic share in the energy levelized cost. In this case power conditioning share is about 20% of the LCC and has a COE of 0.60 – 0.55 €/kWh, caused by the high unit cost of (imported components from Europe). In case 4 – 7 cost of power conditioning is reduced by 27% by using local components, a COE of 0.52 – 0.47 €/kWh. These results match the obtained values from actual PV system cost analysis of Thailand country [Rakwichian, 2004]. Comparing the PVHS COE, the result shows that PVHS has a more attractive COE than PVS and GE. In this case, it shows a very attractive COE of DGS. The DSG gives a higher COE when the surplus energy is taken into account. Surplus energy from DGS is almost 1.3 times the daily energy demand of the system, which means energy lost is 3,578 kWh/y.

### 5.3 Case of Samaki, Cambodia

#### 5.3.1 Description of Samaki

##### *Location and renewable energy resources*

Samaki village is in the Prey Nop district of the Kompong Som province (Sihanouk Ville). Samaki is a remote village located on the Kompong Smach River, 5 km from Viel Reng market (**Figure 5-9**). The village is unlikely to have immediate access to grid electricity, and the access road to the village is usually badly affected during the rainy season. There are 40 households in the village, with a population of about 200. The average yearly family income is approximately 320 €, and almost all the income comes from agriculture and fishing. The villagers generally use kerosene and fuel wood for lighting. Certain households with commercial activities, and those who have higher incomes, use batteries for lighting, watching television and listening to the radio. For recharging the batteries, they carry the batteries to the nearest charging station, which costs 1,000 Riels (approximately 0.20 €) for one cycle of recharging. Usually one charge can last five days of use.

Renewable energy resources in Samaki have been analyzed as only solar irradiation (**Table 5-4**). Irradiation is quite high with an average value of 5.1 kWh/m<sup>2</sup>.d [Li, 2000]. As a result, solar irradiation is considered the only renewable energy source for the PVHS.



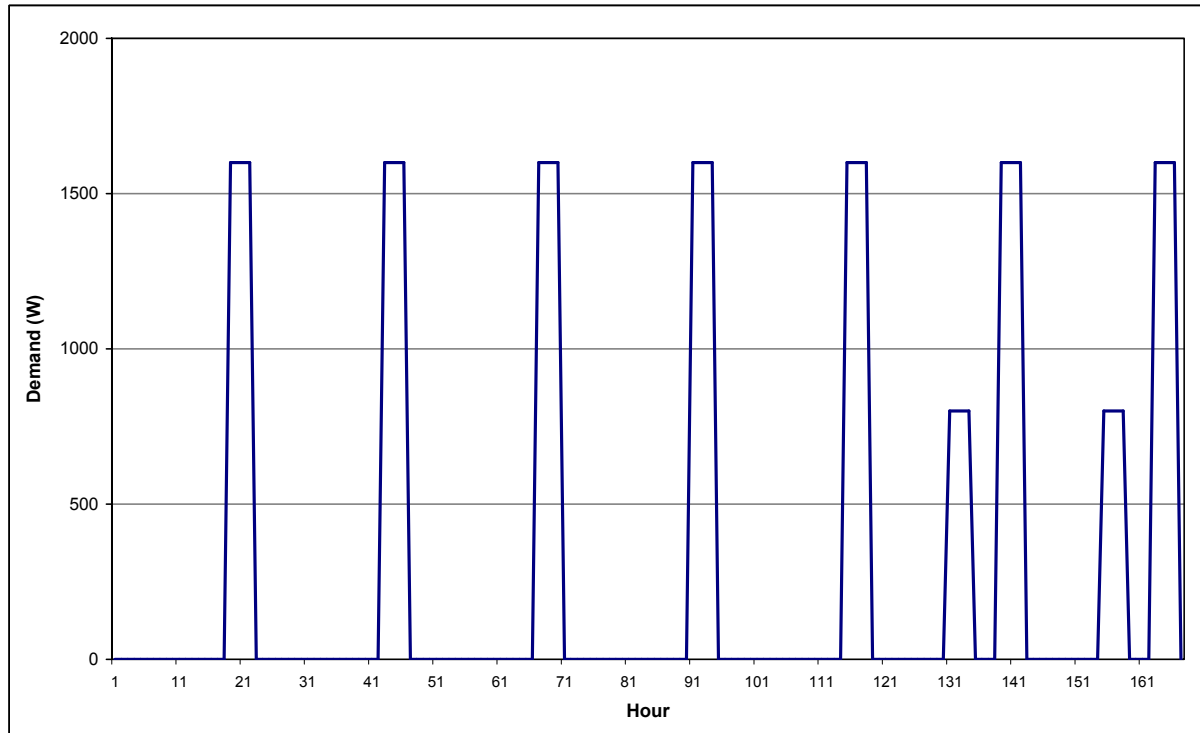

**Figure 5-10:** Weekly demand profile of Samaki village generated by RES

### 5.3.2 Input of RES

The main configuration to be investigated in this case is the typical PVHS. The technical and economic assumption parameters of the simulated models of each component are similar in *Section 5.2.2*. The component of the PVHS the described below:

- **PV generator**                    1.5 kW
- **Diesel generator**                5 kW
- **Battery storage**                  15 kWh
- **Power conditioning**        1.5 kW grid inverter / 3.3 kW battery inverter

### 5.3.3 System performance results of PVHS at Samaki

#### *Energy consumption*

The annual energy demand of this system is 2,669 kWh, average daily energy demand is 7.3 kWh and the energy produced by diesel-generator over the year is 51.4 kWh (**Figure 5-11**).

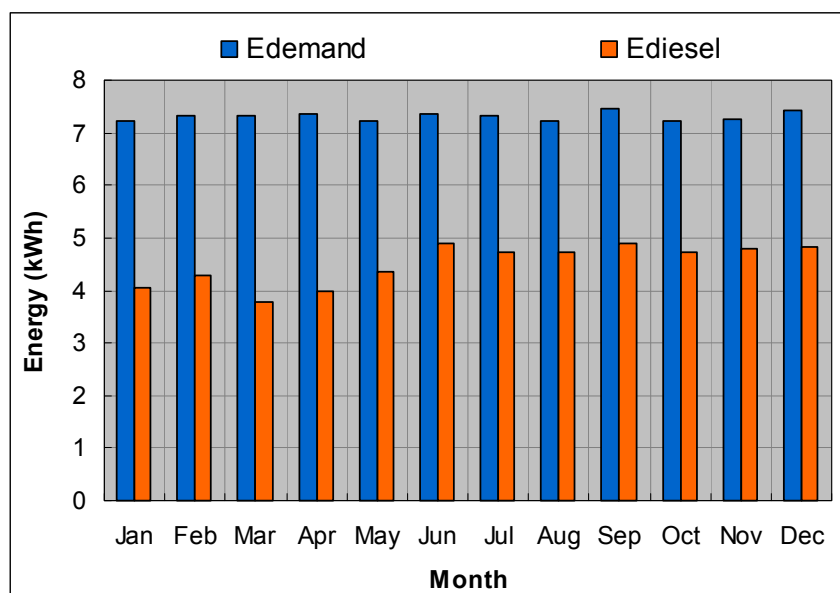

**Figure 5-11:** Correlation of daily energy demand and energy produced by diesel-generator

### ***Balance of energy***

**Figure 5-12** presents as a brief overview the simulated energy balance of the PVHS at Samaki with the RES. The daily average energy produce by PV is 7.2 kWh, the daily average energy supply by diesel generator is 4.5 kWh. Daily average of net energy use from PV is 4.9 kWh and no surplus energy in the system. The data shows that about 68% of the energy produced by PV can be used.

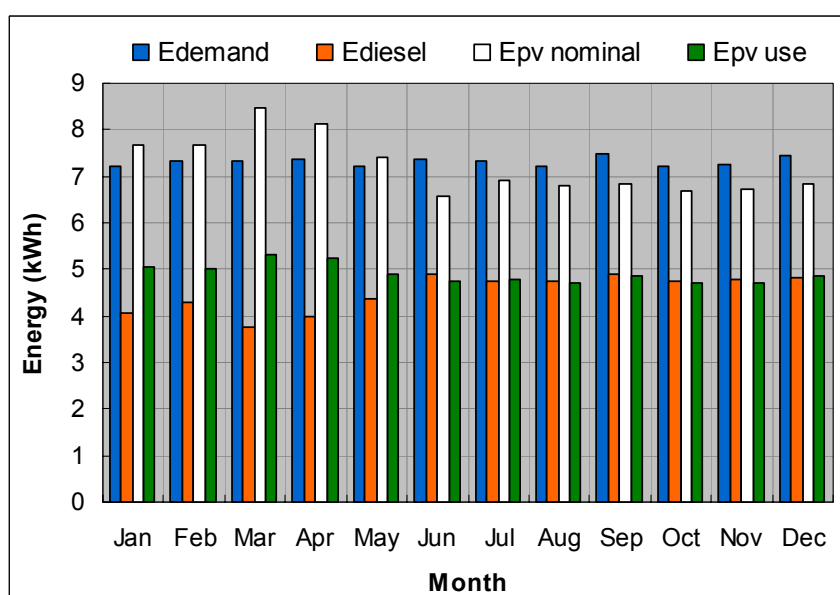

**Figure 5-12:** Energy balance of the PVHS at Samaki

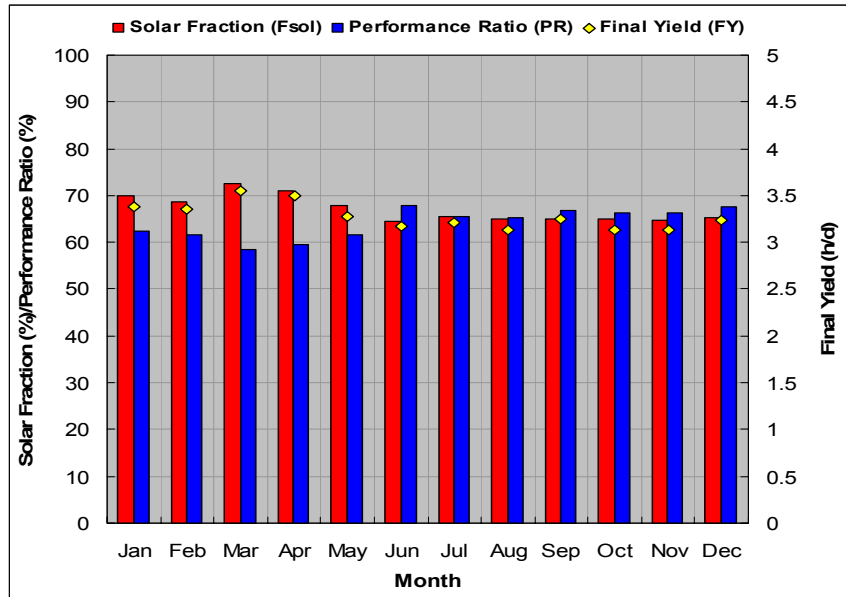

Figure 5-13: System performance of the PVHS at Samaki

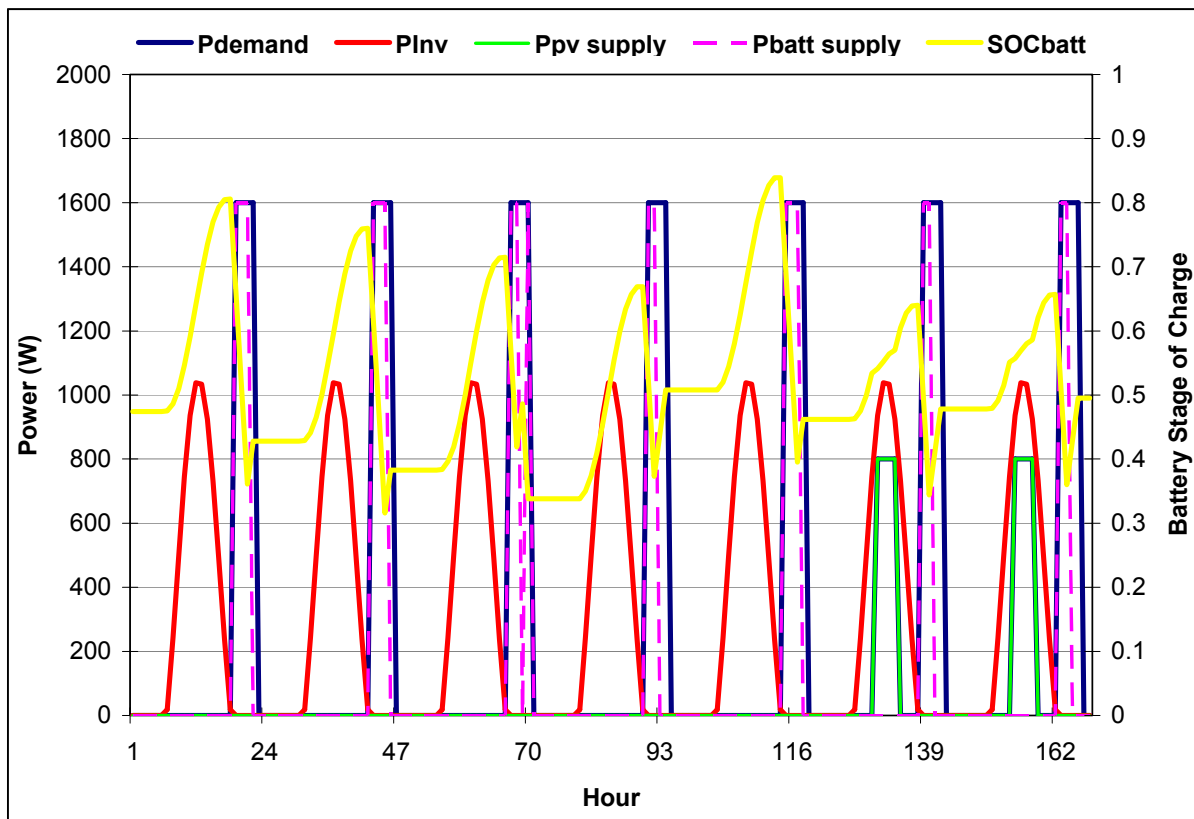

Figure 5-14: Weekly power supply by PV, battery and battery SOC of the PVHS at Samaki

**System performance**

Figure 5-13 presents the PVHS performance; the *PR* of 64% indicates that on an annual base under the prevailing conditions, 36% of the nominal energy is not available for load supply due to losses in reflection, higher module temperature,

cable and conversion losses, even if the station is continuously used daily. The annual average  $F_{sol}$  of the system is 67% and  $FY$  is 3.3 h/d. The potential of the system is comparably high to the potential range of PV hybrid system. One reason is the high uniformity of the irradiation profile throughout the year and the good match between production and consumption.

**Figure 5-14** shows the distribution of weekly system availability of the PVHS at Samaki. The demand load supplied directly by PV (P<sub>pv</sub> supply) is about 800 W; the remaining load is supplied by battery storage. The frequency distribution of the Battery SOC range in the considered evaluation period moves between 0.3 – 0.85. The SOC indicates how often the battery is found in a charge state.

### 5.3.4 Economics performance results of PVHS at Samaki

**Table 5-5** shows the summary of the different cases (case 1-6 is PVHS, case 7 is PVS, case 8 is DGS and case 9 is GE).

**Table 5-5:** Comparison of the difference assumption of the PVHS economics study and PVS, DGS and GE

Description	Case1	Case2	Case3	Case4	Case5	Case6	Case7	Case8	Case9
PV investment cost (€/kW)	3,000	3,000	3,000	2,600	2,600	2,600	3,000	-	-
Diesel generator (€/kW)	400	400	400	400	400	400	-	400	-
Battery storage (€/kWh)	160	160	160	140	140	140	160	-	-
Power conditioning (€/kW)	1,019	1,019	1,019	737	737	737	1,019	-	-
Grid extension (€/km)	-	-	-	-	-	-	-	-	14,000
Transformer (30 kVA)	-	-	-	-	-	-	-	-	600
BOS (%of investment cost)	17	17	17	20	20	20	10	55	5
O&M (%of investment cost)	25	25	25	29	29	29	4	178	3
Replacement cost (%of investment cost)	30	30	30	27	27	27	34	18	5
Interest rate (%)	5	7.5	10	5	7.5	10	5	5	5
Inflation rate (%)	0.5	0.5	0.5	0.5	0.5	0.5	0.5	0.5	0.5
Initial investment cost (€)	16,580	16,580	16,580	14,330	14,330	14,330	13,480	4,000	37,600
LCC (€)	24,685	23,246	22,101	21,369	20,154	19,182	17,856	8,279	68,026
COE (€/kWh)	0.69	0.65	0.62	0.60	0.57	0.54	0.75	0.51	1.28

Note: 1,000 Riels = 0.20 € / Import tax = 30% / Vat 10%

An analysis of the LCC of the different system assumption is explained in **Figure 5-15**. This figure shows that the LCC of case 1 – 3 of the PV array and power conditioning represents a basic share in the energy levelized cost. In this case power conditioning share about 20% of LCC and has a COE of 0.69 – 0.62 €/kWh, caused by the high



unit cost of its (imported components from Europe). In case 4 – 7 cost of power conditioning is reduced by 27% by using components from neighboring countries, a COE of 0.60 – 0.54 €/kWh. These results match the obtained values from actual PV system cost analysis of Cambodia country [Li, 2002]. Comparing the PVHS COE, the result shows that PVHS has a more attractive COE than PVS and GE. In this case it shows a very attractive COE of DGS. The DSG matches power to the loads demand of the Samaki better than other power supply system (in this study environment cost not taking into account).

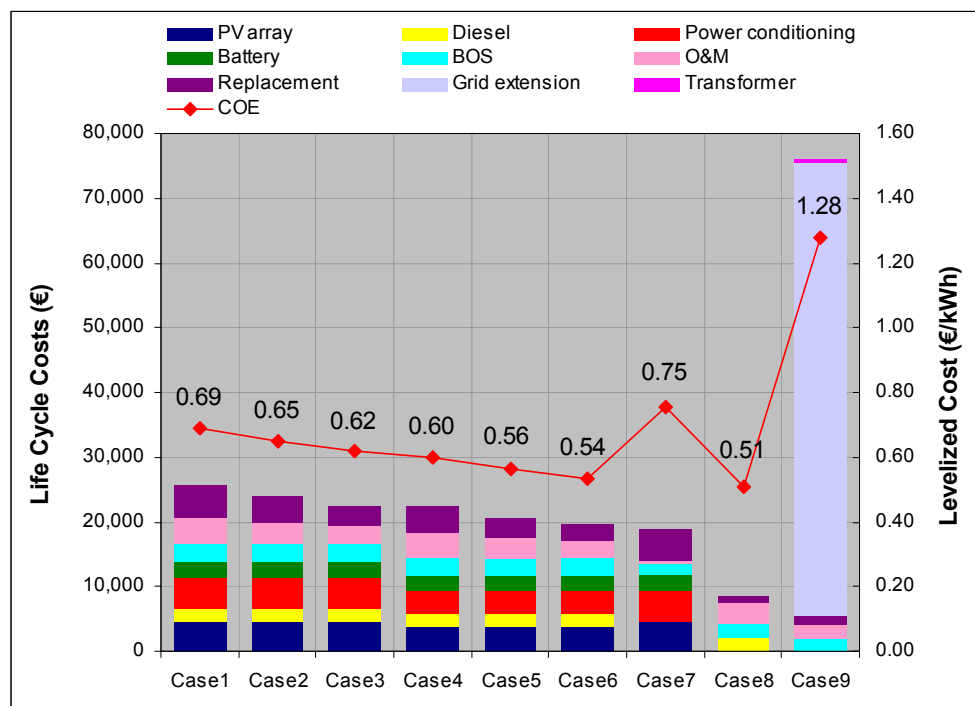

Figure 5-15: LCC analysis of different assumption of Samaki

## 5.4 Case of Thapene, Lao PDR

### 5.4.1 Description of Thapene

#### *Location and renewable energy resources*

Thapene Village is located in the Loungphrabang province. Thapene is a remote village about 30 km from Loungphrabang near Khuangxi waterfalls (Figure 5-16). The village is unlikely to have immediate access to grid electricity, and the access road to the village is usually badly affected during the rainy season. There are 50 households in the village, with a population of about 130. The average yearly family income is approximately 256 €, and almost all the income comes from agriculture and labour work. The villagers generally use kerosene for lighting. Certain

households with commercial activities and those who have higher incomes, use pico hydro power generation for lighting, watching television and listening to the radio. For pico hydro generation, they install the system along the waterfall nearest to their household. The investment costs are about 60 €/kW and the expected lifetime about 5 years [Source: Thapene pico hydro survey by SERT]. In this research pico hydro technology not taken in to account.

As mentioned above, renewable energy resources in Thapene have been analyzed as only solar irradiation. The annual mean daily global solar radiation in the country is in the range 4.50 - 4.70 kWh/m<sup>2</sup>.d [Douangvilay, 2002].

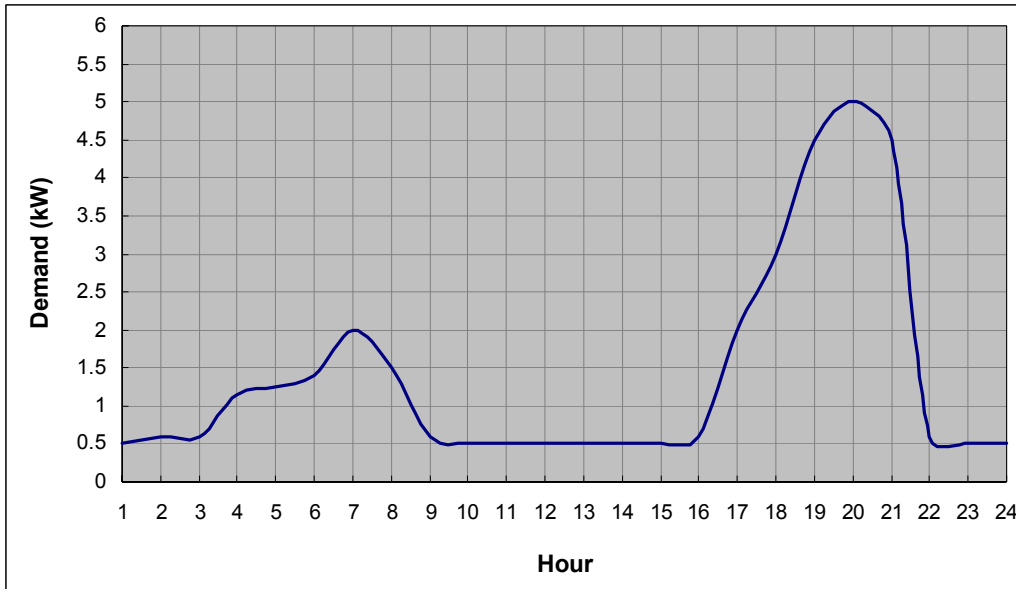

Figure 5-16: Map of Laos, location of Thapene Village in Loungphrabang

### ***Load demand of Thapene***

The Thapene case study is especially suitable for showing the trend of electricity demand in poor villages that might expand to big village in the future. Present and

future electricity demands have been observed by the SERT staff. For the evaluation of RES, only the present electricity demand will be taken into consideration. There is a continuous load; the peak load of about 5 kW occurs in the evening period.



**Figure 5-17:** Daily load profile of Thapene village by SERT observation

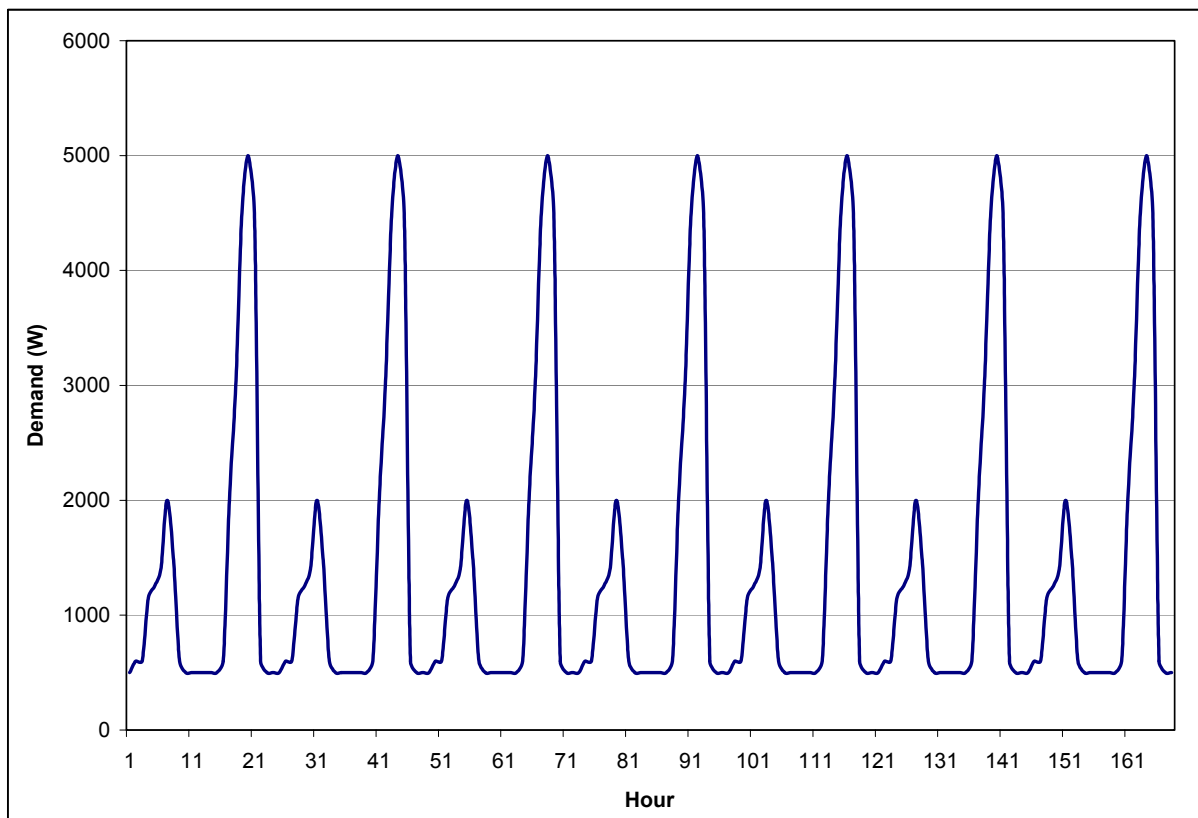

**Figure 5-18:** Weekly load demand profile of Thapene village generate by RES

**Figure 5-17** shows the daily load profile in hourly steps. An average electricity demand is calculated at 33.8 kWh/d. **Figure 5-18** shows the weekly load profile in hourly step generated by RES.

#### 5.4.2 Input of RES

The technical and economic assumption parameters of the simulated models of each component are similar in *Section 5.2.2*. The components of the PVHS are described below:

- **PV generator**                    9 kW
- **Diesel generator**                8 kW
- **Battery storage**                 90 kWh
- **Power conditioning**        3 x 3 kW grid inverter / 3 x 3.3 kW battery inverter

#### 5.4.3 System performance results of PVHS at Thapene

##### *Energy consumption*

The annual energy demand of this system is 12,337 kWh, average daily energy demand is 33.8 kWh and the energy produces by diesel-generator over the year is 195.3 kWh (**Figure 5-19**).

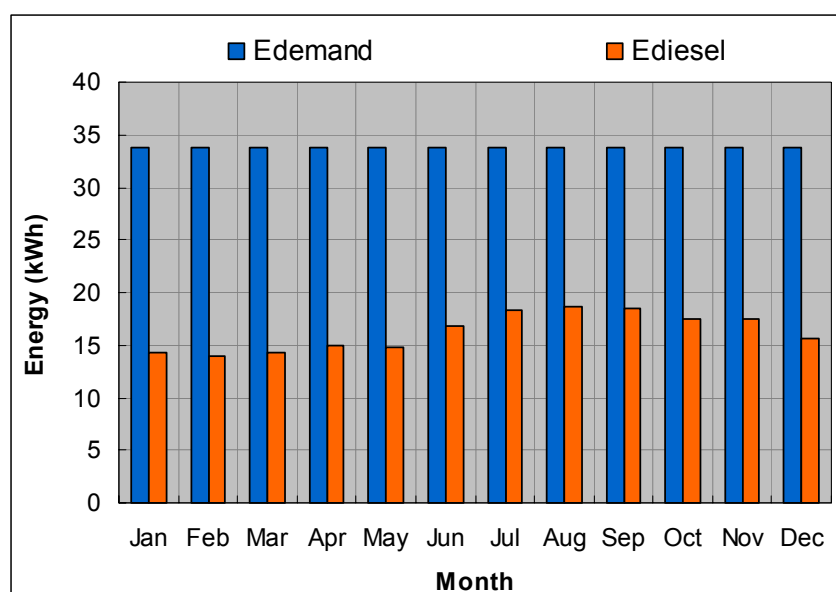

**Figure 5-19:** Correlation of daily energy demand and energy produced by diesel-generator

**Balance of energy**

**Figure 5-20** presents as a brief overview the simulated energy balance of the PVHS at Thapene with the RES. The daily average energy produced by PV is 41.4 kWh; the daily average energy supplied by diesel generator is 16.3 kWh. Daily average of net energy use from PV is 29.4 kWh and without any surplus energy in the system. The data shows that about 71% of the energy produced by PV can be used.

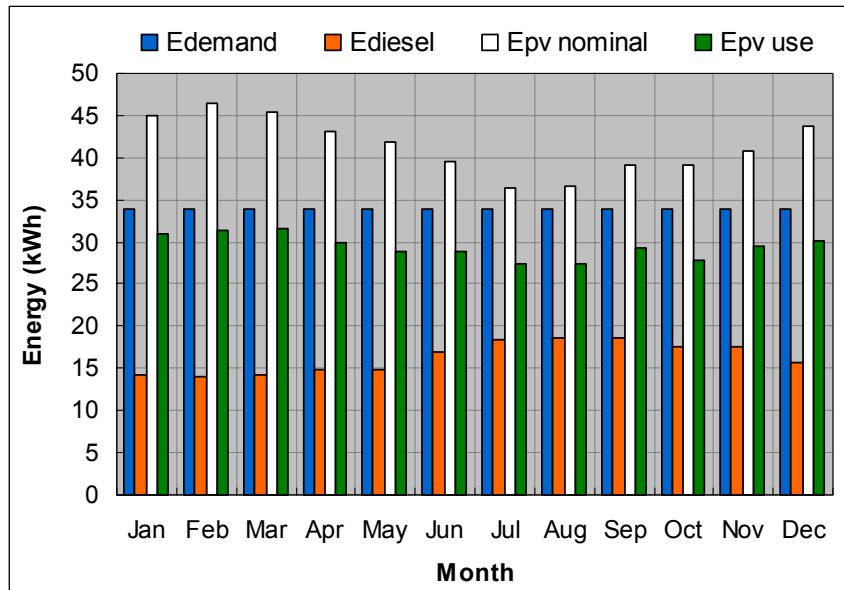

**Figure 5-20:** Energy balance of the PVHS at Thapene

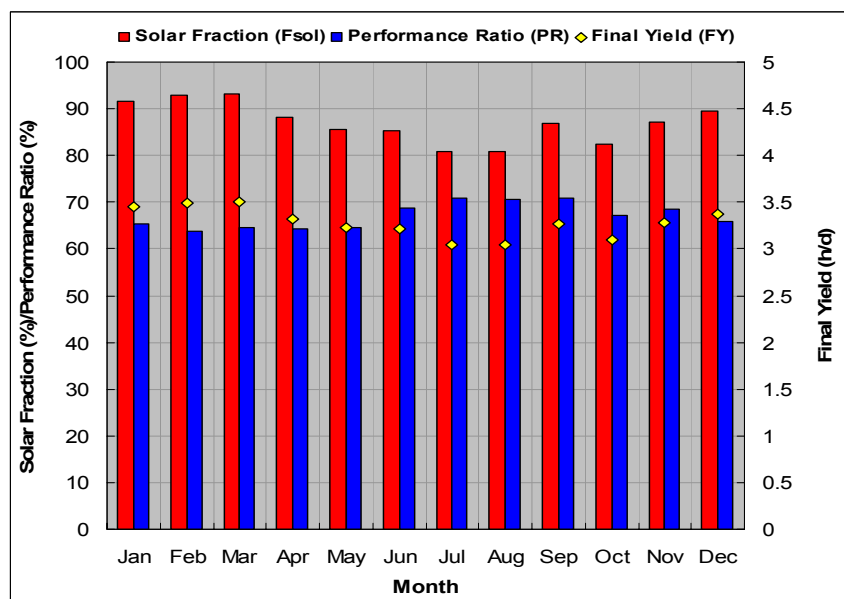

**Figure 5-21:** System performance of the PVHS at Thapene

### System performance

**Figure 5-21** presents the PVHS performance at Thapene; the PR of 67% indicates that on an annual base under the prevailing conditions, 33% of the nominal energy is not available for load supply due to losses in reflection, higher module temperature, cable and conversion losses, even if the station is continuously used daily. The annual average  $F_{sol}$  of the system is 87% and  $FY$  is 3.3 h/d. This potential of the system is comparably very high to the potential range of PV hybrid system. One reason is the high uniformity of the irradiation profile throughout the year and power supply match with the load profile of the Thapene.

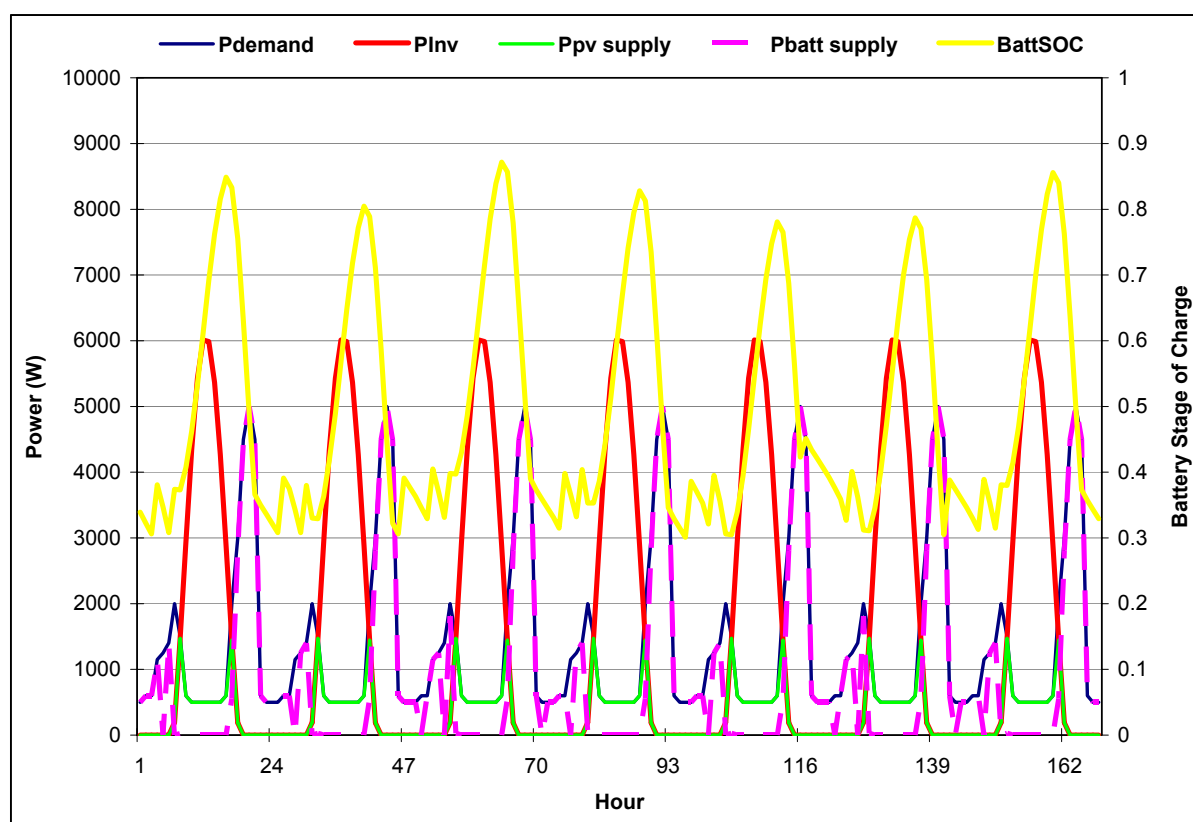

**Figure 5-22:** Distribution weekly power supply by PV, battery and battery SOC of at Thapene

**Figure 5-22** shows the distribution of weekly system availability of the PVHS at Thapene. The demand load supplied directly by PV ( $P_{pv}$  supply) about 1,500 W, remain load supply by battery storage. The frequency distribution of the Battery SOC range in the considered evaluation period moving between 0.3 – 0.85. The SOC indicates how often the battery is found in a charge state.

#### 5.4.4 Economics performance results of PVHS at Thapene

**Table 5-6** shows the summary of the cases with different assumptions similar to the previous section.

**Table 5-6:** Thapene comparison of the different assumptions of the PVHS economics study and PVS, DGS and GE

Description	Case1	Case2	Case3	Case4	Case5	Case6	Case7	Case8	Case9
PV investment cost (€/kW)	3,000	3,000	3,000	2,600	2,600	2,600	3,000	-	-
Diesel generator (€/kW)	400	400	400	400	400	400	-	400	-
Battery storage (€/kWh)	160	160	160	140	140	140	160	-	-
Power conditioning (€/kW)	948	948	948	705	705	705	948	-	-
Grid extension (€/km)	-	-	-	-	-	-	-	-	10,000
Transformer (30 kVA)	-	-	-	-	-	-	-	-	600
BOS (%of investment cost)	8	8	8	10	17	17	8	62	1
O&M (%of investment cost)	11	11	11	13	19	19	1	145	12
Replacement cost (%of investment cost)	22	22	22	26	27	27	29	15	1
Interest rate (%)	5	7.5	10	5	7.5	10	5	5	5
Inflation rate (%)	0.5	0.5	0.5	0.5	0.5	0.5	0.5	0.5	0.5
Initial investment cost (€)	61,115	61,115	61,115	51,920	51,920	51,920	57,815	10,500	202,600
LCC (€)	80,468	77,355	74,708	68,429	65,785	63,548	71,166	15,650	185,887
COE (€/kWh)	0.37	0.36	0.35	0.32	0.31	0.30	0.41	0.36	0.75

Note: 1,000 Kip = 0.1 €

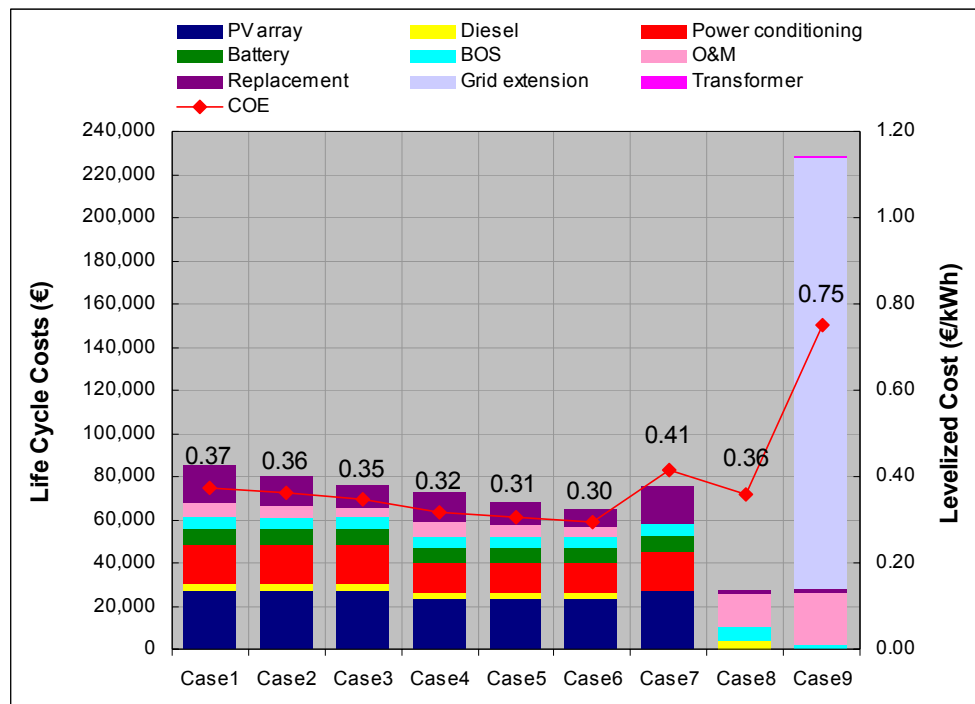

**Figure 5-23:** Thapene LCC analysis of different assumption

**Figure 5-23** shows an analysis of the LCC of the different technology power system assumptions. This figure shows that in cases 1 – 3, the PV array and power conditioning represent a basic share in the energy levelized cost. In these cases, the PV array is about 44% of LCC and power conditioning (imported components from Europe) is 29% of LCC and has an average COE of 0.36 €/kWh. In cases 4 – 7, PV array share is about 45%, cost of power conditioning is reduced by 26% by using components from neighboring countries, and an average COE is 0.31 €/kWh. Comparing the PVHS COE, the result shows that PVHS has a more attractive COE than PVS and GE.

## 5.5 Summary and outlook

In this section levelized cost comparisons for PVSH, PVS, DGS and GE technologies were conducted for the three case studies in selected countries of the Mekong Country. Assumptions and parameters used for technical and economic performance are described. In the research, an analysis evaluates village scale systems by using RES software. Each system was evaluated at its maximum energy demand (kWh). In order to compare the technical and economics of different technologies and renewable energy resources, an analysis was based on SERT & CORE's database.

The PVHS under evaluation can serve small village loads, from about 2,500 kWh/y to 12,500 kWh/y (depend on the solar energy resource and installed capacity). PVHS had shown very high *PR* for every range of villages energy demand (more than 60%). An average  $F_{sol}$  of the systems is more than 70% and *FY* is more than 3.0 h/d at every energy demand range. The annual power supplied by PV, battery and the battery SOC of the system has shown a very interesting point of view for energy management systems. Almost all batteries are never full again after its first operation; it moves between 0.3 – 0.7 depending on system DOD setting. The battery management system may be need for additional study in the future.

Household surveys conducted in the Region indicate that most families consume 500 – 600 Wh/d, mainly for lighting, radio and small TV set. When a small refrigerator is introduced, daily consumption rises to 1.0 -1.5 kWh/d [CORE].



**Figure 5-24** shows that PVHS can meet increased energy demand at relative cost reduction to the user, improving this system's competitive standing over DGS, which can suffer long down-time due to maintenance needs, part failures and fuel shortfalls. COE of the PVHS is moves from 0.50 – 0.30 €/kWh, PVS is 0.70 – 0.50 €/kWh, DGS is 0.60 – 0.40 €/kWh and GE is 1.00 – 0.80 €/kWh.

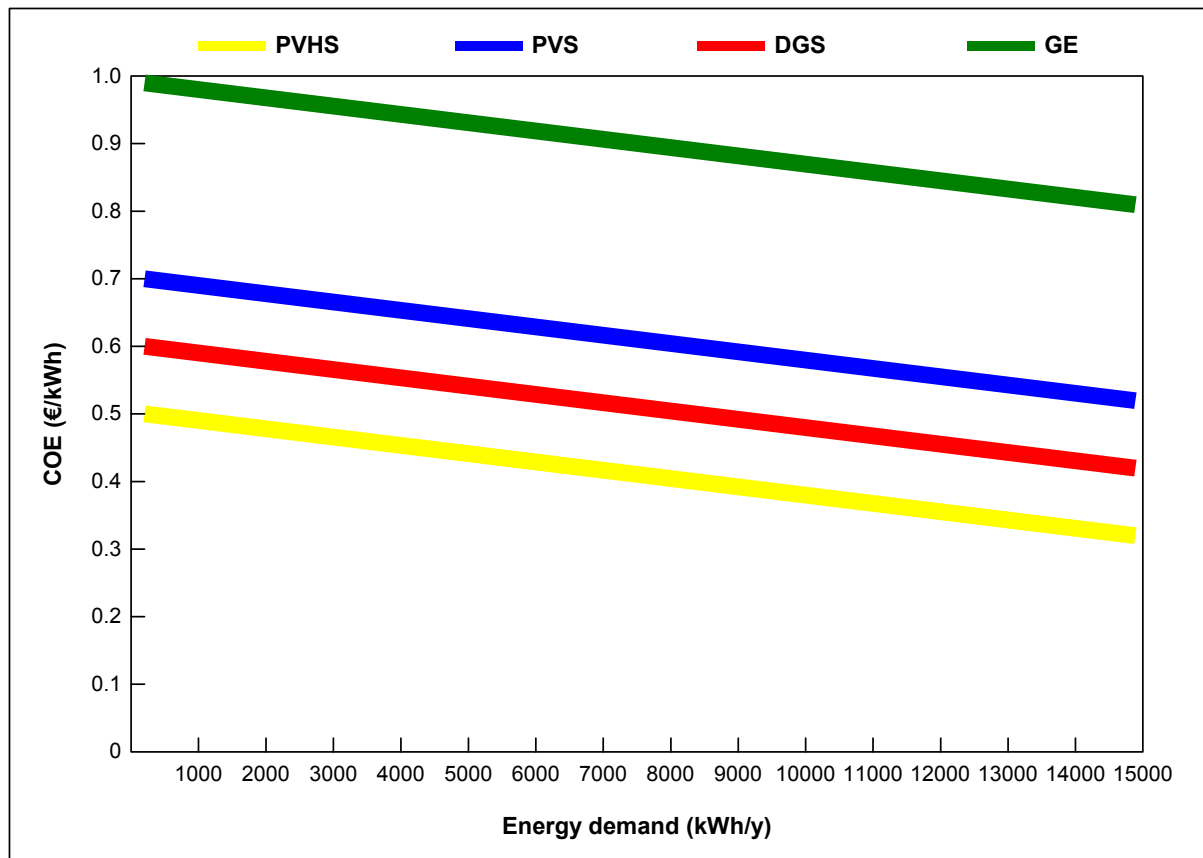

**Figure 5-24:** Levelized costs for PVHS, PVS, DGS and GE in selected countries of Mekong Country

The PVHS has shown very attractive results in both technical and economic performance for their rural electrification in the Mekong Country, especially in countries like Cambodia, Lao PDR Myanmar and Vietnam, which have a low percent of rural household electricity access (see *Chapter 2*).

## 6 CONCLUSIONS AND RECOMMENDATIONS

Rural electrification is now and will remain an essential element for rural areas of the Mekong Countries. Renewable energy technologies, such as photovoltaic hybrid systems can provide an economical option for meeting energy demands of remote rural villages in these regions. The most frequent reasons for PV project failure are system designs that are not appropriate to the user, improper component selection, installation and most importantly lack of quality technical and economic pre-feasibility studies.

This research covered four aspects:

- Implementation of field tests, monitoring and evaluation of the PVHS at Energy Park of School of Renewable Energy Technology in order to test the PVSH working under the metrological conditions of the Mekong Country (**Chapter 3**).
- Develop a software simulation, which studies the technical and economic performance of rural electrification options. This software must be easy to use and understand for the energy planner on rural electrification projects (**Chapter 4**)
- Evaluate the technical and economic performance of the PVHS base on renewable energy potential for rural electrification of Mekong Country by using the developed software (**Chapter 5**).
- To give guidance for the possible use of PVHS application in this region, particularly in regard to its technical and economic sustainability (**Chapter 5**)

The following conclusion may be drawn from these results:

- The implementation of field test has successfully been done in the context of a research project. The PVHS installation based on ISET concept has proven to be an efficient operation for power supply systems. The evaluation of the system shown the FY is about 3.5 kWh/kWp and the daily average energy produced by diesel generator is 0.12 kWh/kW. The daily average PV energy use is 6.9 kWh. The data shows the energy used produced by PV is about 79%. The *PR* of system is 66.6% indicates that on an annual base under the prevailing conditions 33.4% of the nominal energy is not available for load supply due to losses in reflection, higher module temperature, cable and conversion losses, even if the station is continuously used.

- RES is a sizing, simulation and economic analysis tool for both renewable energy and conventional energy technology applications. Renewable technology consists of PV-Diesel Hybrid System, Stand-alone PV Station, Solar Home System and Centralized PV Battery Charging Station. Conventional technology consists of Stand-alone Diesel Generator Station and Grid Extension. The technical result shows all energy data which are useful when used for comparison with other system types. The economics result shows net present value, life cycle costs and levelized costs of each system which the user can use to compare with another system technology. This software can offer highly accurate results based on the actual meteorological database input by the user for each area. This software serves as a useful tool for energy planners and system designers when selecting the most appropriate rural electrification option and offering the most optimal technical and economic benefits for the people living in rural areas.
- The PVHS under evaluation can serve a small village load, from about 1000 kWh/y to 15000 kWh/y. PVHS has shown very high  $PR$  for every range of villages energy demand (more than 60%). An average  $F_{sol}$  of the systems is more than 70% and  $FY$  is more than 3.0 h/d at every energy demand range. The annual power supplied by PV, battery and the battery SOC of the system has shown a very interesting point of view for energy management systems. Almost all batteries are SOC moves between 0.3 – 0.8 depending on the system DOD settings. PVHS can meet increased energy demand at relative cost reduction to the user, improving this system's competitive standing over DGS, which can suffer long down-time caused by maintenance needs, part failures and fuel shortfalls. COE of the PVHS is moving from 0.50 – 0.30 €/kWh, PVS is 0.70 – 0.50 €/kWh, DGS is 0.60 – 0.40 €/kWh and GE is 1.00 – 0.80 €/kWh.

### 6.1 Outlook and future work

Most of the current PV projects have been made without technical and economic pre-feasibility study. Nevertheless, the rate of system failures in even these systems is less than that of small diesel generator system for rural electrification. This is an indication of the reliability of the PV. The combination of PV and diesel generator so call hybrid system presents an attractive option for rural electrification of the Mekong Country. But in real situations, there are still many problems the need to be studied in the future such as actual system operation and reliability. System developments are

not enough for PV rural electrification projects. PVHS promotion should be made following the principle of proper design and adequate maintenance is performed; the number of satisfied users will be increase. PVHS is not the only choice for rural electrification but it is one of the proper choices for the Mekong Country. Other renewable energy options such as wind, biomass and hydro power need to be studied in the future.



## 7 REFERENCES

**Anil, C. et al (1996)** “Best Practices for Photovoltaic Household Electrification Programs: Lessons from Experiences in Selected Countries,” WORLD BANK TECHNICAL PAPER NUMBER 324, ASIA TECHNICAL DEPARTMENT SERIES. page 7-8.

**Asian Development Bank (1999)** “Asian Development Outlook 1999,” Oxford University Press. <http://www.adb.org/Documents/Books/ADO/default.asp>

**Asian Development Bank (2000)** “Asian Development Outlook 2000,” Oxford University Press. <http://www.adb.org/Documents/Books/ADO/default.asp>

**Asian Development Bank (2001)** “Asian Development Outlook 2001,” Oxford University Press. <http://www.adb.org/Documents/Books/ADO/default.asp>

**Asian Development Bank (2004)** “Asian Development Outlook 2004,” Oxford University Press.

**Asian Institute of Technology (AIT) (1998)** “NEPO/DANCE: Investigation of Pricing in a Renewable Energy Strategy, Photovoltaics for Electrification in Thailand”

**Byrne, J. et al (1998)** “The Economics of Sustainable Energy for Rural Development: Study of Renewable Energy in Rural China,” Energy Policy Journal. Vol. 26(1). pp. 45-54.

**Castañer, L. and Silvestre, S. (2002)** “Modelling Photovoltaic System using PSpice®.” John Wiley & Sons.

**Cherus, D. C. (2004)** “Modeling, Simulation, and Performance Analysis of a Hybrid Power System for a Mobile Medical Clinic,” Doctor of Engineering thesis, University of Kassel.

**Council on Renewable Energy in the Mekong Region (CORE) (2003)** “Renewable Energy Policy Report in the Mekong Country”

**Davis, M (1995)** “Institutional Frameworks for Electricity Supply to Rural Communities – A literature review,” EDRC, University of Cape Town.

**Department of Energy Development and Promotion, (DEDP) (2000).** “Solar Radiation Map of Thailand.”

**Department of Energy Development and Promotion (DEDP) (2001)** “Wind Resource Assessment of Thailand.”

**Doi Tung Development Royal Project** “Ethnic and Hill-Tribe Communities,” <http://www.doitung.org/Doitung/travel/ethnic.asp>

**Douangvilay, B. (2002)** “Renewable Energy Development in Lao PDR,” Master of Science Independent Study. School of Renewable Energy Technology, Naresuan University.

**Duffie, J. A. and Beckman, W. A. (1991)** “Solar Engineering of Thermal Process.” 2<sup>nd</sup> edition. New York. John Wiley & Sons.

**Hansen, A. D. et al (2000)** “Models for a Stand-Alone PV System.” Risø-R-1219(EN)/SEC-R-12. Risø National Laboratory, Roskilde.

**Kruangpradit, P. et al (2002)** “Feasibility Study on Renewable Energy Electrification in Remote Villages Project,” The International Conference on Village Power from Renewable Energy in Asia. Phitsanulok, Thailand, 11 – 14 November 2002.

**Khunchornyakong, W. (2004)** “The First PV Mega Project in Thailand for “The Right to Know”. Technical Digest 14<sup>th</sup> Photovoltaic Science and Engineering Conference; 26-30 January 2004; Bangkok; Thailand; 529-530.

**Ketjoy, N. (1999)** “Development of a Mathematical Model of Changing Temperature and Relative Humidity in the Poultry House.” Master of Science Thesis (Energy Technology). School of Energy and Material. King Mongkut's University of Technology Thonburi.

**Ketjoy, N. (2002)** “PV Hybrid System at Energy Park,” Naresuan University Journal. Vol 10 (1): 1-8.

**Ketjoy, N. et al (2002)** “Hybrid Power Mini-Grid System for Rural Electrification”. Proceedings the International Conference on Village Power from Renewable Energy in Asia; 11-14 November 2002; Phitsanulok; Thailand; 47-52.

**Ketjoy, N. et al (2003)** "RES 2.0 a Software Simulation of PV - Diesel Hybrid System for Rural Electrification." Proceedings of 2<sup>nd</sup> European PV-Hybrid and Mini-Grid Conference; 25-26 September 2003; Kassel; Germany; 386-391.

**Ketjoy, N. et al (2003)** "A Study of Mini- Grid Concept for Unelectrified Village in Thailand," Proceedings on ENERGY & ENVIRONMENT-A World of Challenges and Opportunities, 1<sup>st</sup> International Conference on Energy and Environment, Changsha, China, October 11-14, 2003

**Ketjoy, N. et al (2003)** "PV-Diesel Hybrid/Mini-Grid System in Thailand," Internal report Mini-Grid-Kit project.

**Ketjoy, N. et al (2003)** "Mini-Grid Application by Renewable Energy for Unelectrified Village in Thailand." Naresuan University Journal. Vol 11 (2): 99-115.

**Ketjoy, N. et al (2004)** "Performance of PV-Diesel Hybrid System at the School of Renewable Energy Technology." Technical Digest 14<sup>th</sup> Photovoltaic Science and Engineering Conference; 26-30 January 2004; Bangkok; Thailand; 837-838.

**Ketjoy, N. et al (2004)** "First Year Investigation of PV Mini Grid System in Chiangria Province of Thailand." Proceedings of 19<sup>th</sup> European Photovoltaic Solar Energy Conference; 7-11 June 2004; Paris, France.

**Landau, M. et al (2002)** "Renewable Energies in Distributed Generation Systems," VDI-GET-Tagung, Entwicklungslinien der Energietechnik, 4-5 September 2002, Bochum.

**Langley Research Centre (LaRC)** "Surface Solar Energy Data Set," NASA, <http://eosweb.larc.nasa.gov/sse/>

**Le, H. T. et al (1997)** "Solar Energy in Vietnam," Second Asian Renewable Energy Conference. Phuket, Thailand, 5-9 November 1997.

**Li, K. (2002)** "Rural Solar Home Systems in Cambodia," Master of Science (Renewable Energy) Independent Study, Naresuan University.

**Manwell, J. F. et al (1998)** "Hybrid2- A Hybrid System Simulation Model Theory Manual." National Renewable Energy Laboratory. Subcontract No. XL-1-11126-1-1.



**Markvart, T. (2000)** "Solar Electricity," Second Edition, John Wiley & Sons, Ltd., pp. 121.

**National Climatic Data Centre (NCDC);** <http://www.ncdc.noaa.gov/>

**Nieuwenhout et. al (2001)** "Monitoring of solar home systems in China: first year results." 17th European Photovoltaic Solar Energy Conference; 22-26 October 2001; Munich, Germany.

**NEDO, NEDO News;** Compiled and Edited by IIEC Asia for NEDO: Issue #1: Renewable Energy

**Nilsson, M. et al (2003)** "Development and Natural Resources in the Mekong Region: The Institutional Challenge," <http://www.ref-msea.org/mreg.html>, January 22, 2003.

**Radka, M. (2005)** "Public Private Partnerships: Issues, Prospectors and Basic Rules," Rural Electrification Workshop. Siam City Hotel, Bangkok, Thailand, 23 – 25 February 2005.

**Rakwichian, W. et al (2004)** "A Study of Mini-Grid Concept for the Villages without Electricity in Thailand." Report submits to National Research Council of Thailand.

**RETScreen International (2003)** "Clean Energy Project Analysis: RETScreen Engineering & Cases Textbook."

**Samy, S. (2005)** "Rural Electrification by Renewable Energy in Cambodia," Rural Electrification Workshop. Siam City Hotel, Bangkok, Thailand, 23 – 25 February 2005.

**Sathienyanon, P. et al (2003)** "A Study On The Status Of And Prospects For Renewable Energy Development And Deployment In Thailand," Master of Science Independent Study. School of Renewable Energy Technology, Naresuan University.

**Schmid, J. et al (2001)** "Review or advances in PV systems technology," European RE Conferences 2001/2002 Integrated Initiative for PV, Wind & Biomass Technologies for European Competitiveness on the World RE Markets.

**SMA Regelsysteme GmbH (2000)** “Sunny Boy Control User Manual Issue 2.2: Enhances Data Acquisition for Sunny Boys with Sunny Boy Control and Sunny Boy Control Plus.” SUNBC-12:NE4900.

**Solar Energy Research and Training Center (SERT) (2000)** “Energy policy trend in Thailand and other Southeast Asia Countries (Vietnam, Cambodia, Lao PDR, and Myanmar)”

**Stoecker, W. F. (1989)** “Design of Thermal Systems.” 3<sup>rd</sup> edition. McGraw-Hill.

**Strauss, P. et al (2003)** “AC coupled PV hybrid systems and micro grid-start of the art and future trends,” 3<sup>rd</sup> World Conference on Photovoltaic Energy Conversion, Osaka, Japan, 11-18 May 2003.

**Turcotte, D. (2001)** “Photovoltaic hybrid system sizing and simulation tools: status and needs,” PV Horizon: Workshop on Photovoltaic Hybrid Systems, Montreal, September 10, 2001.

**Wichert, B. et al (1999)** “Photovoltaic-diesel hybrid energy systems for remote area power generation,” TECH MONITOR, Jan-Feb 1999, pp. 31-38.

**World Bank and Electricity of Vietnam (1998)** “Rural Electrification Master Plan Study – Vietnam. Study Report 1 – Rural Development, Status and Strategy”

**World Climate** “Weather rainfall and temperature data,” <http://www.worldclimate.com/>

**World Resources Institute (1998)** “1998-99 World Resources Report. Environmental Change and Human Health,” New York & Oxford, Oxford University Press. <http://www.adb.org/Documents/Books/ADO/default.asp>

**World Energy Council (WEC) and Food Agriculture Organization of the United Nations (FAO) (1999)** “The Challenge of Rural Energy Poverty in Developing Countries” page 30 – 31.

**World Energy Council (WEC) and Food Agriculture Organization of the United Nations (FAO) (1999)** “The Challenge of Rural Energy Poverty in Developing Countries” page 66 – 67.

**Yaron, G. et al (1994)** “Solar Energy for Rural Communities: The case of Namibia.” Intermediate Technology Publications.

**Zuming, L. et al (2001)** "Renewable Energy Utilization in Remote Areas in Yunnan, China," Conference on Cooperation toward a Sustainable Energy Future. Ho Chi Minh City, Vietnam, 6-10 February 2001.

## 8 APPENDICES

### 8.1 Appendix A: The hybrid system prototype drawing

**Table 8-1: Components list**

Designation	Description	Properties/Comments
A1	Distribution box	35x52 cm
A2	Battery inverter	SMA Sunny Island 3300
A3	Grid connected inverter	SMA Sunny Boy 1700E
A4	Datalogger	SMA Sunny Boy Control
A5	Datalogger	Delphin topmessage
A6	Circuit breaker distribution box	25x35 cm
A7	Simulator load	Heater 500W x 6, Variable 0-3,000W, Voltage range 200-240V, max. current 15A
A8	Generator junction box	
A9	Generator A/Hz meter panel box	20x30 cm
A10	DC Power Supply, 24V	Power 10W required for Delphin topmessage
A11	DC Power Supply, 12V	Required for Energy Meter
B1	Sensor battery temperature for Sunny Island	PT100
B2	Sensor module temperature	PT100
B3	Sensor ambient temperature	PT100
B4	Pyranometer	Kipp & Zonen CM11, Sensitivity 5.02 $\mu\text{V}/\text{W}/\text{m}^2$
C1	Sunny Boy connector for data transmission cable	
E1	Ventilator fan	
F1	Fuse switch disconnecter of PV Array (+)	30A
F2	Fuse switch disconnecter of PV Array (-)	30A
F3	Fuse switch disconnecter of Battery (+)	63A
F4	Fuse switch disconnecter of Battery (-)	63A
F5	Fuse switch disconnecter of AC outlet (L)	16A/400V
F6	Fuse switch disconnecter of AC outlet (N)	16A/400V
F7	Battery inverter AC outlet circuit breaker	30A
F8	Grid connected inverter AC outlet circuit breaker	30A
F9	Diesel Generator AC outlet circuit breaker	30A
F10	Consumer load circuit breaker	30A
F11	Simulator load circuit breaker	30A
F12	Village load circuit breaker	30A
F13	Water pumping circuit breaker	30A
G1	Battery Bank	60V, 18 kWh, EXIDE TECHNOLOGIES, CLASSIC 4 SOLAR 305
G2	PV Array	2kWp, BP SOLAR 75Wp @ 26 module
G3	Diesel Generator	5kVA, HONMAR 5GFLE
K1	Relay for control of diesel generator contactor circuit	
K2	Relay for control of load contactor circuit	
K3	Solid state relay	For adjust simulator load
L1	LED lamp of Heater1	
L2	LED lamp of Heater2	
L3	LED lamp of Heater3	
L4	LED lamp of Heater4	
L5	LED lamp of Heater5	
L6	LED lamp of Heater6	
M1	Ampare Meter panel of simulator load	
R1	Heater1	500W
R2	Heater2	500W
R3	Heater3	500W
R4	Heater4	500W
R5	Heater5	500W
R6	Heater6	500W
S1	Switch for Heater1	
S2	Switch for Heater2	
S3	Switch for Heater3	
S4	Switch for Heater4	
S5	Switch for Heater5	
S6	Switch for Heater6	
S7	Regulator switch	
T1	Current Transformer Diesel Current	max. input current 25A, output current 5A, CARLO GAVAZZI
T2	Timer switch for Heater1	
T3	Timer switch for Heater2	
T4	Timer switch for Heater3	
T5	Timer switch for Heater4	

**Table 8-1: Components list (continue)**

<b>Designation</b>	<b>Description</b>	<b>Properties/Comments</b>
T6	Timer switch for Heater5	
T7	Timer switch for Heater6	
P1	Diesel Generator Energy Meter	NIEAF MEASURING, SWHM-12; 1-phase kWh-meter, 20A, 230Vac
P2	Simulator load Energy Meter	NIEAF MEASURING, SWHM-12; 1-phase kWh-meter, 20A, 230Vac
P3	Control room Energy Meter	NIEAF MEASURING, SWHM-12; 1-phase kWh-meter, 20A, 230Vac
P4	Village load Energy Meter	NIEAF MEASURING, SWHM-12; 1-phase kWh-meter, 20A, 230Vac
P5	Water pumping Energy Meter	NIEAF MEASURING, SWHM-12; 1-phase kWh-meter, 20A, 230Vac
X3	Modular Terminals	
X4	Modular Terminals	
X5	Modular Terminals	
X6	Modular Terminals	
X7	AC grid connected sockets	Power from Hybrid System
X8	AC grid connected sockets	Power from Hybrid System
X9	Public grid connected sockets	Power supply for Delphin datalogger and kWh-meter
X10	Public grid connected sockets	Power supply for Delphin datalogger and kWh-meter
X11	Modular Terminals	
X12	Modular Terminals	
X13	Modular Terminals	
X14	Modular Terminals	



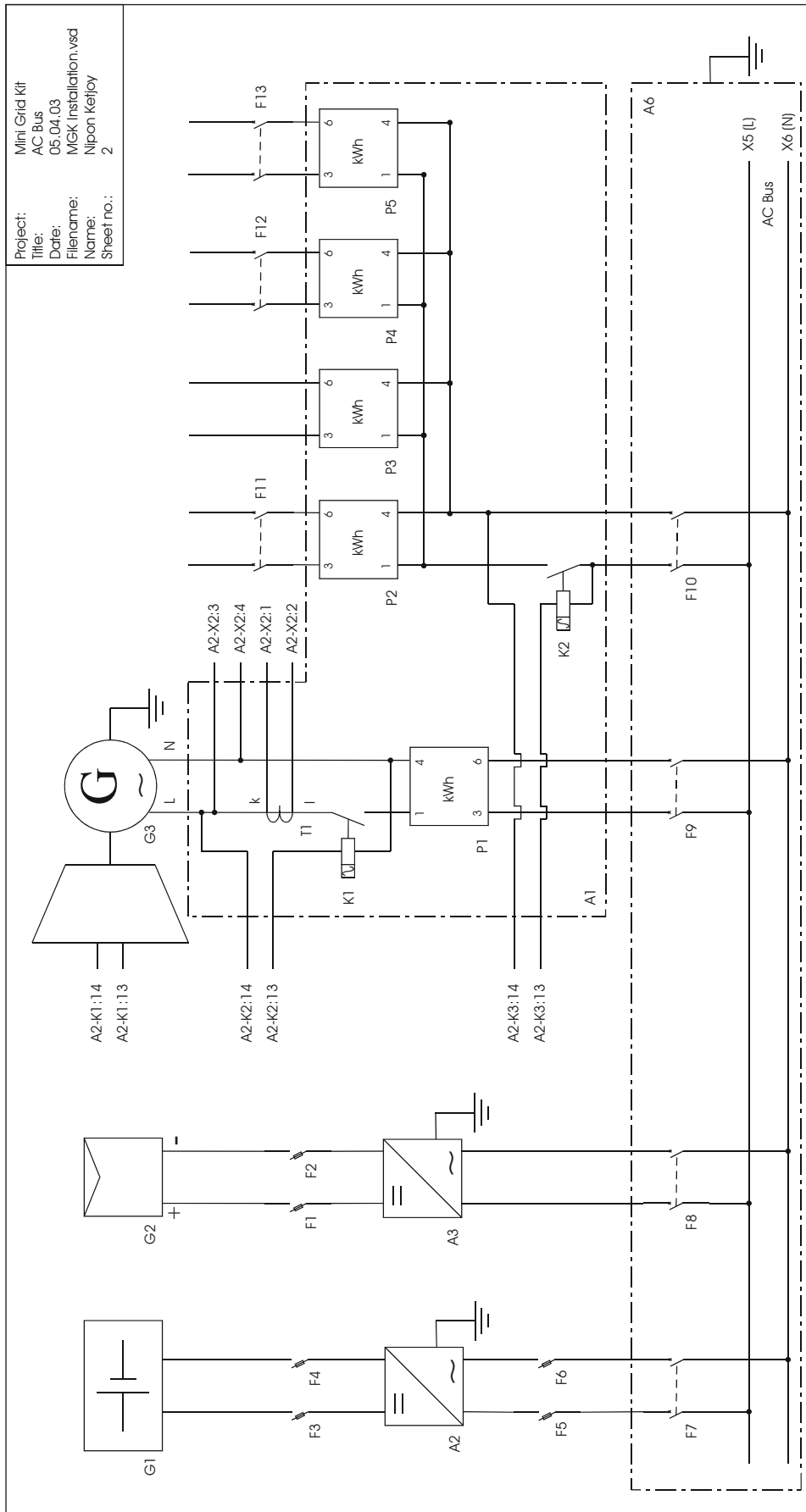

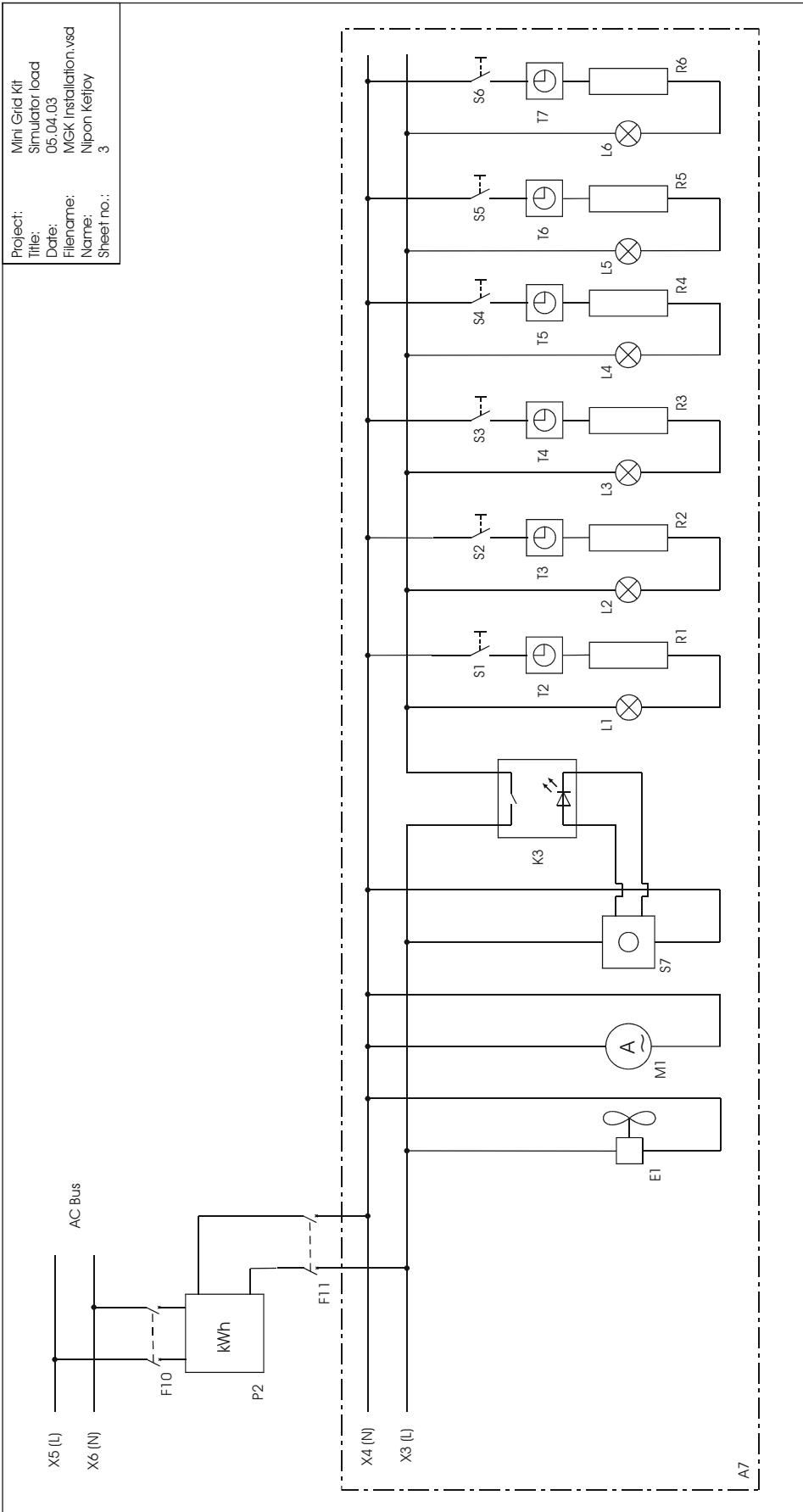



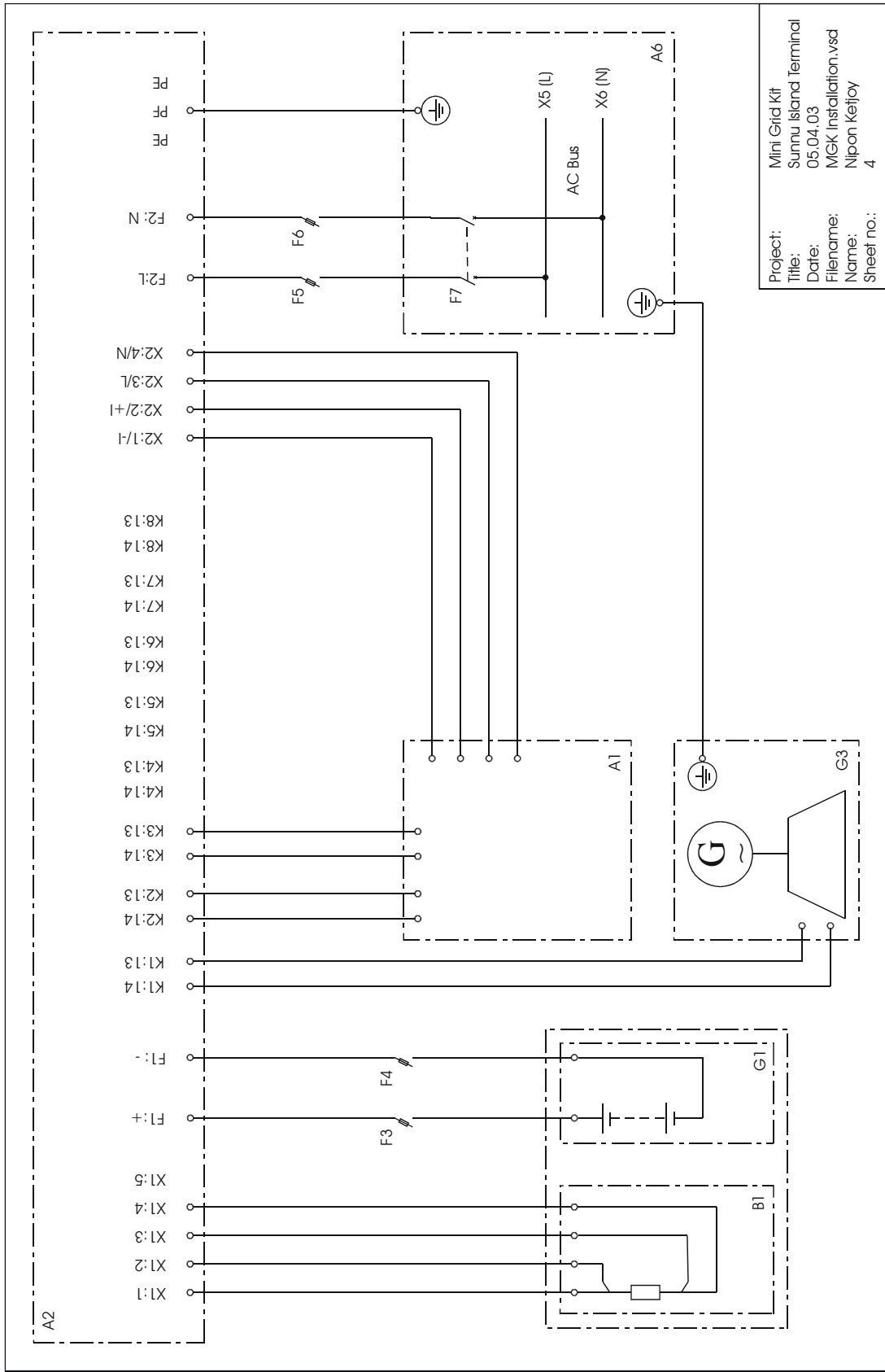

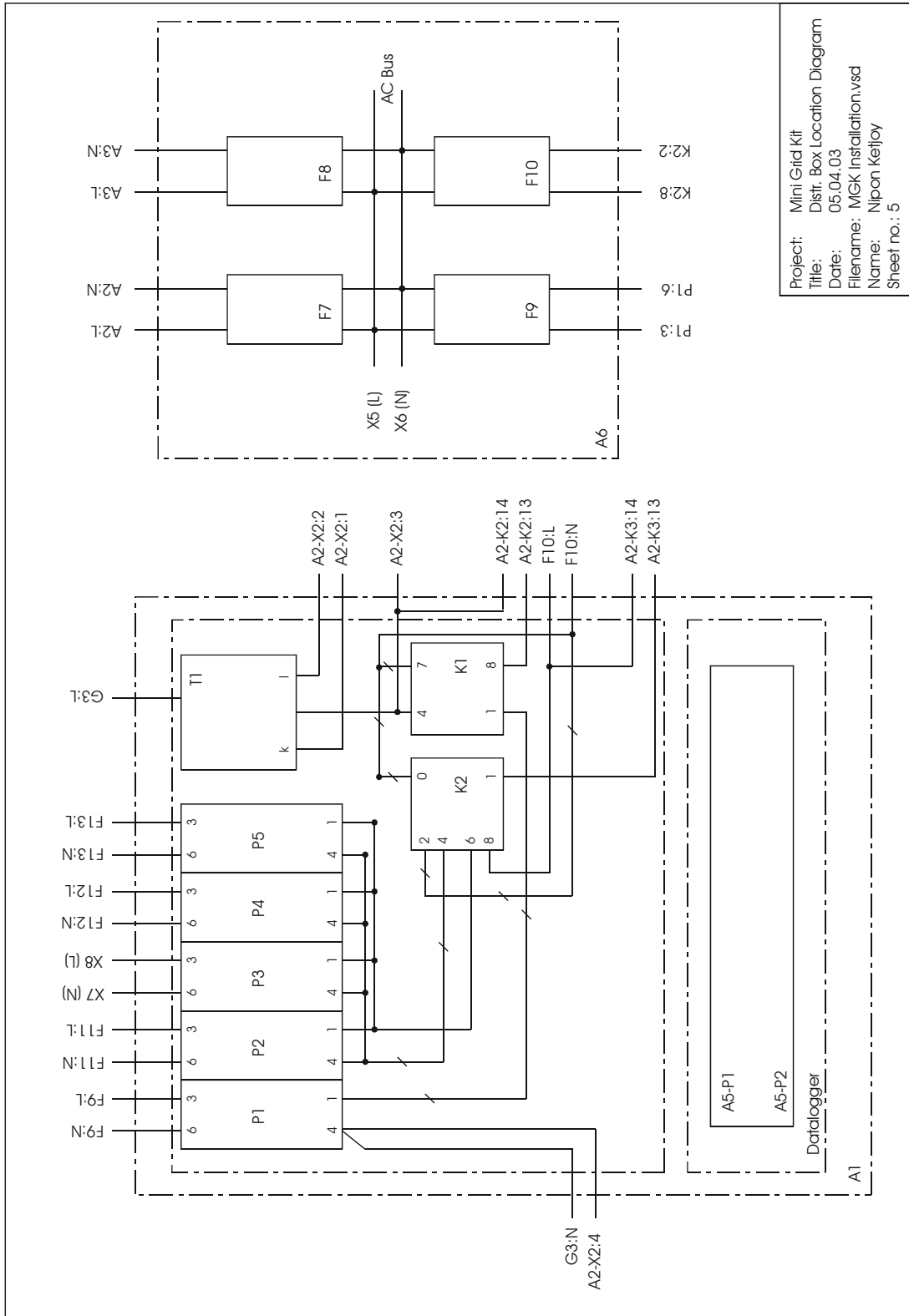

Project: Mini Grid Kit  
 Title: Distr. Box Location Diagram  
 Date: 05.04.03  
 Filename: MGK Installation.vsd  
 Name: Nipon Ketjoy  
 Sheet no.: 5

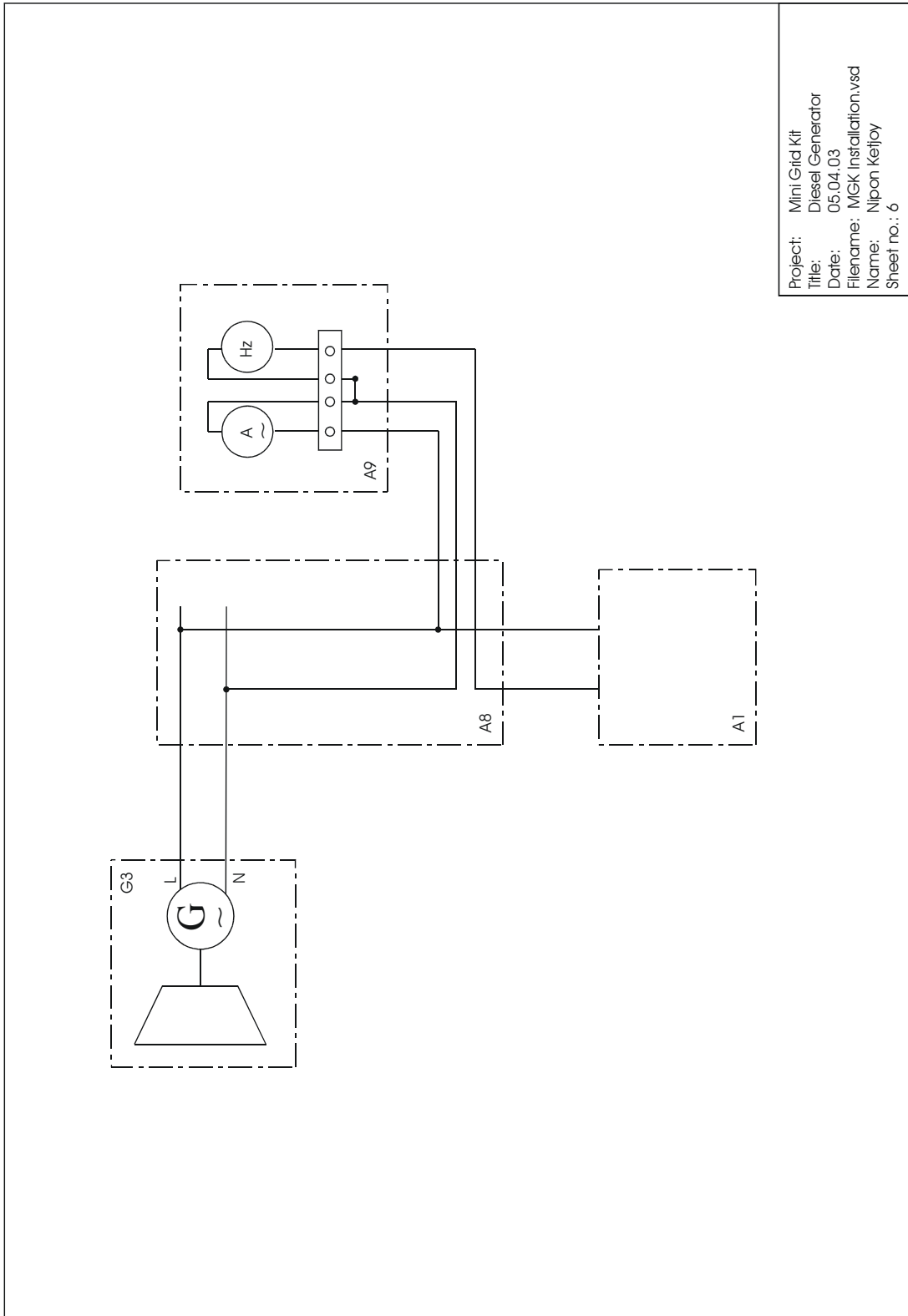

Project: Mini Grid Kit  
Title: Diesel Generator  
Date: 05.04.03  
Filename: MGK Installation.vsd  
Name: Nipon Ketjoy  
Sheet no.: 6

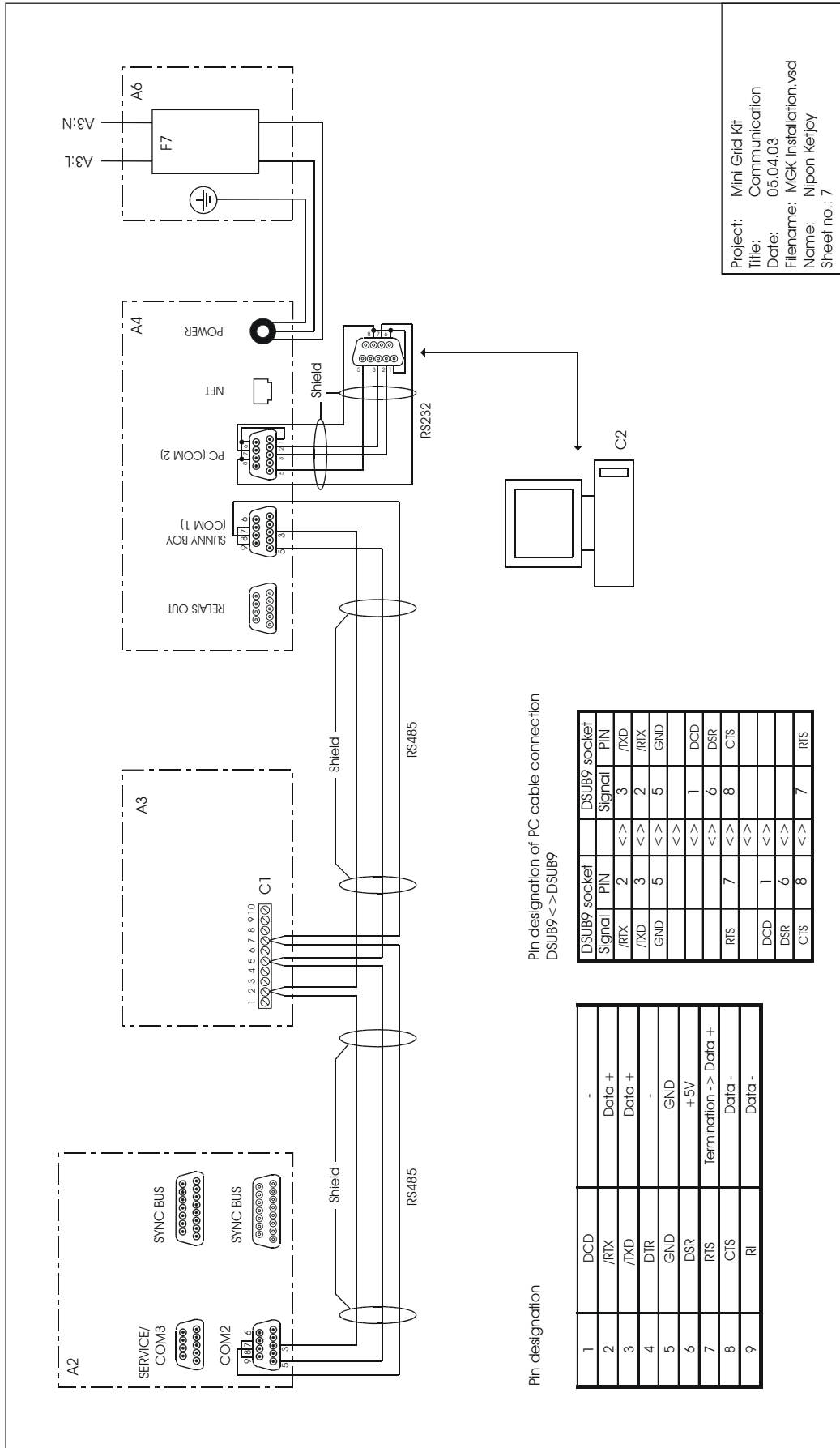

Project: Mini Grid Kit  
 Title: Communication  
 Date: 05.04.03  
 Filename: MGK Installation.vsd  
 Name: Nipon Ketjoy  
 Sheet no.: 7

Pin designation of PC cable connection  
 DSUB9 <-> DSUB9

DSUB9 socket	PIN	Signal	DSUB9 socket	PIN	Signal
/RX	2	<->	3	/TXD	
/TXD	3	<->	2	/RX	
GND	5	<->	5	GND	
		<->			
		<->	1	DCD	
		<->	6	DSR	
RTS	7	<->	8	CTS	
DCD	1	<->			
DSR	6	<->			
CTS	8	<->	7	RTS	

Pin designation

1	DCD	-
2	/RX	Data +
3	/TXD	Data +
4	DTR	-
5	GND	GND
6	DSR	+5V
7	RTS	Termination -> Data +
8	CTS	Data -
9	RI	Data -

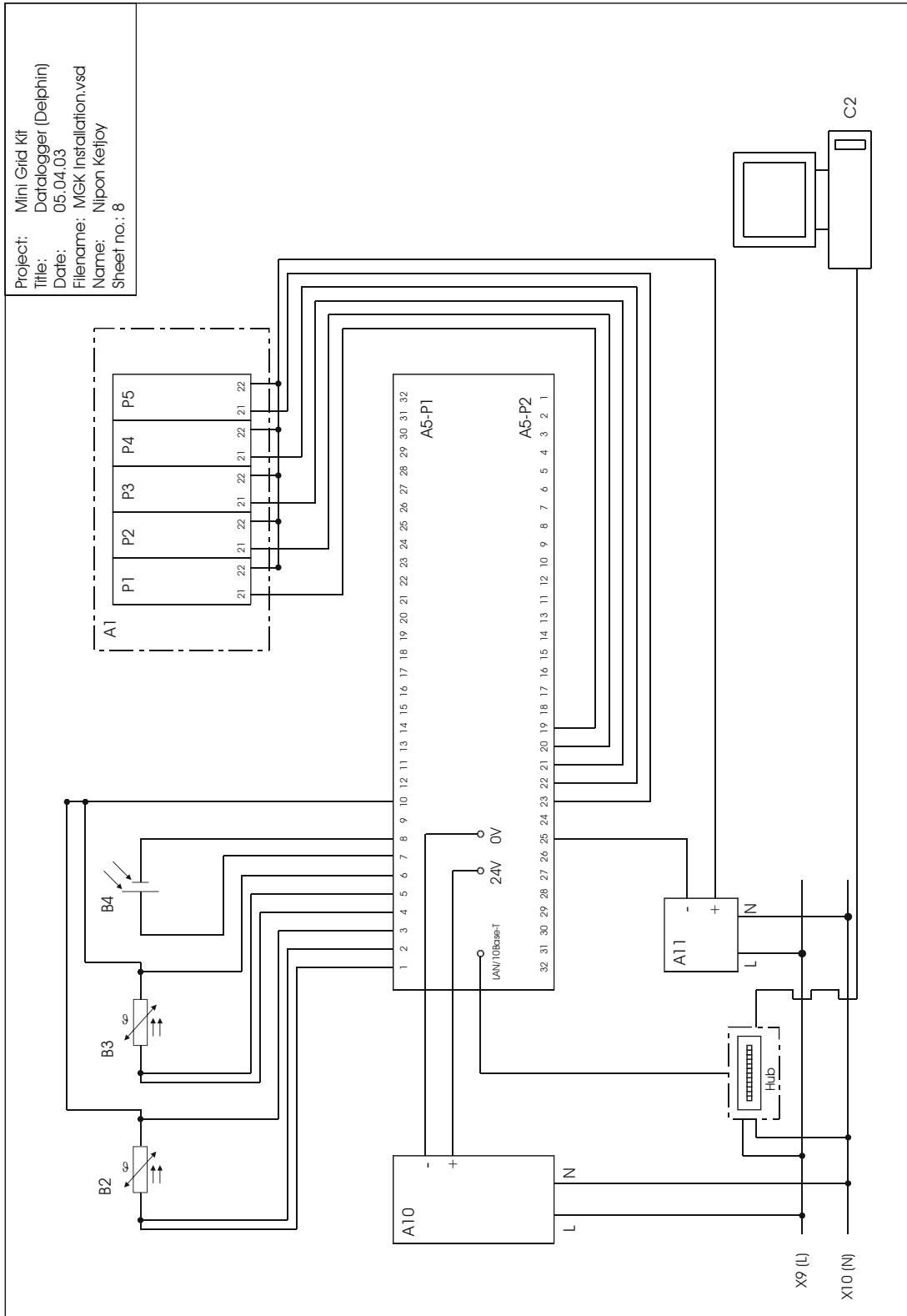

8.2 Appendix B: The algorithms and user interface of RES

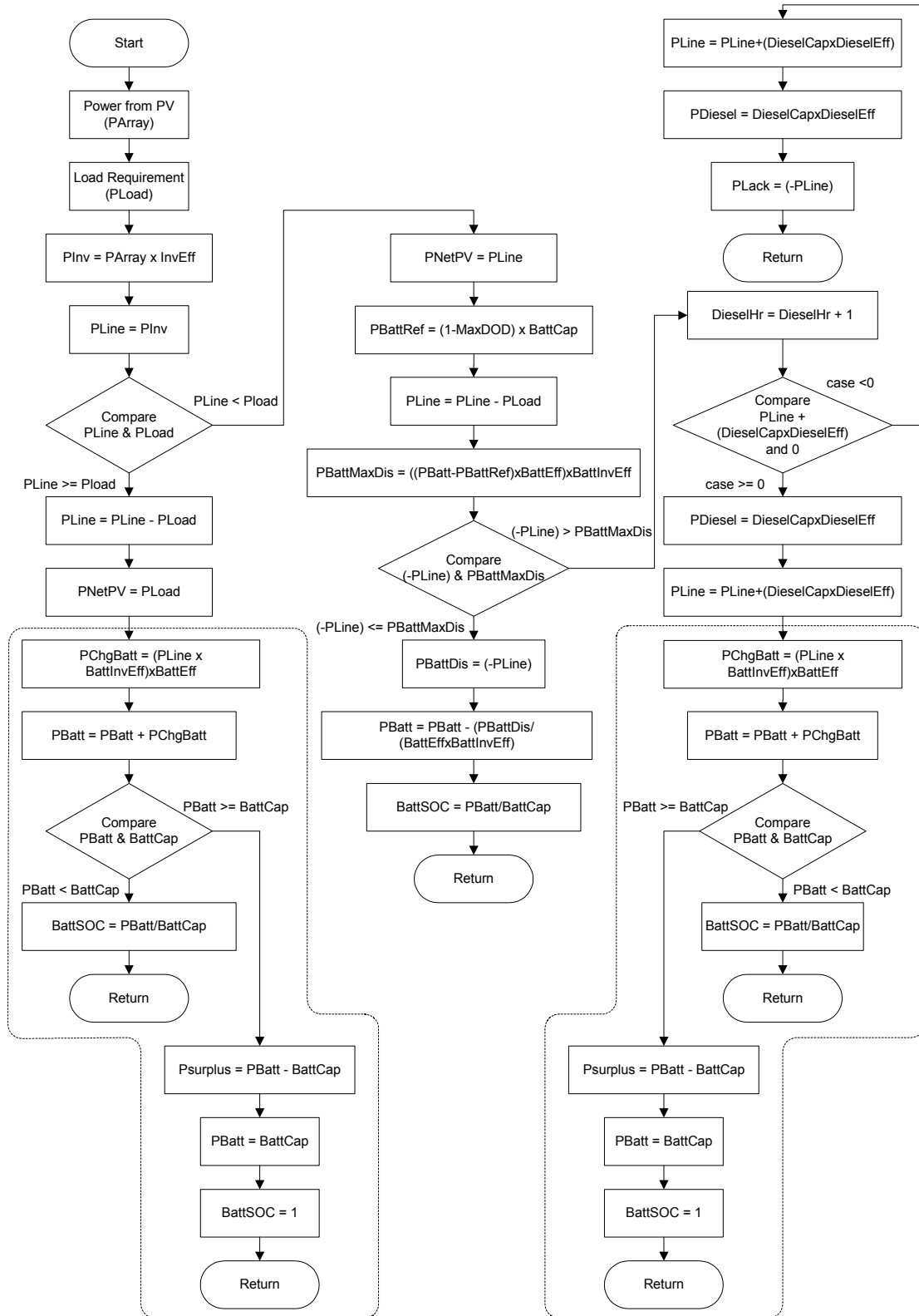

Figure 8-1: PVHS grid tied algorithm

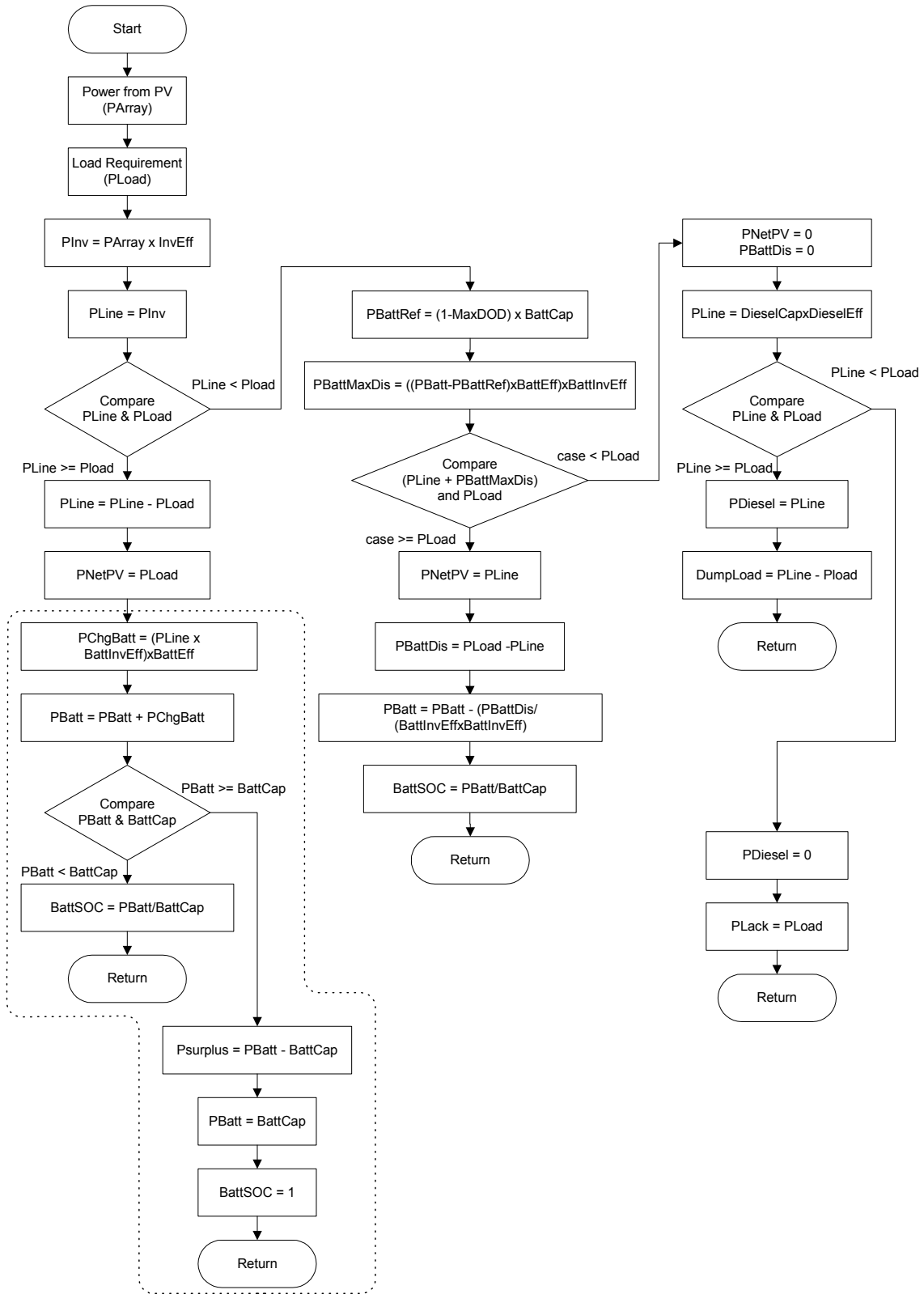

Figure 8-2: PVHS grid forming algorithm

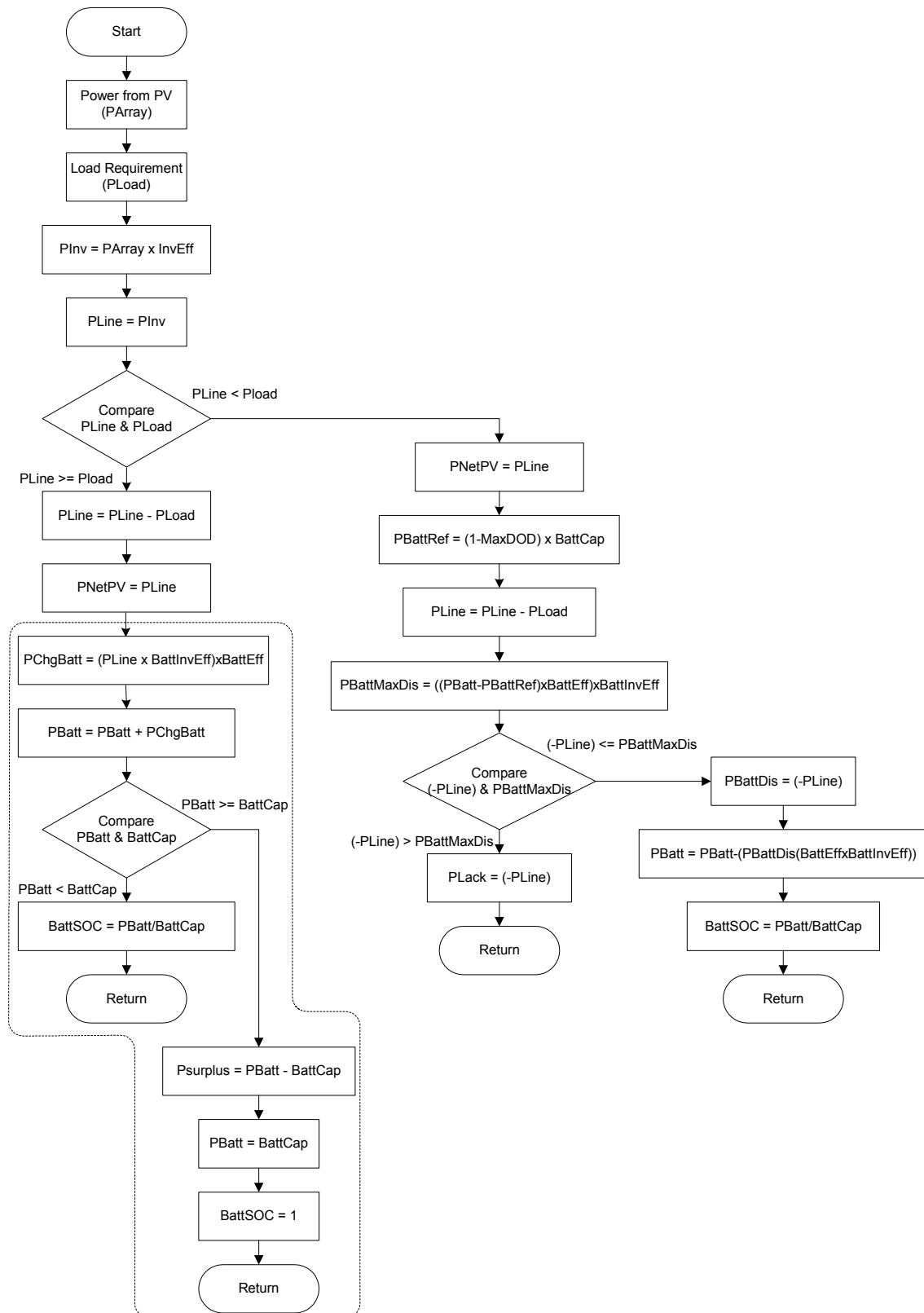
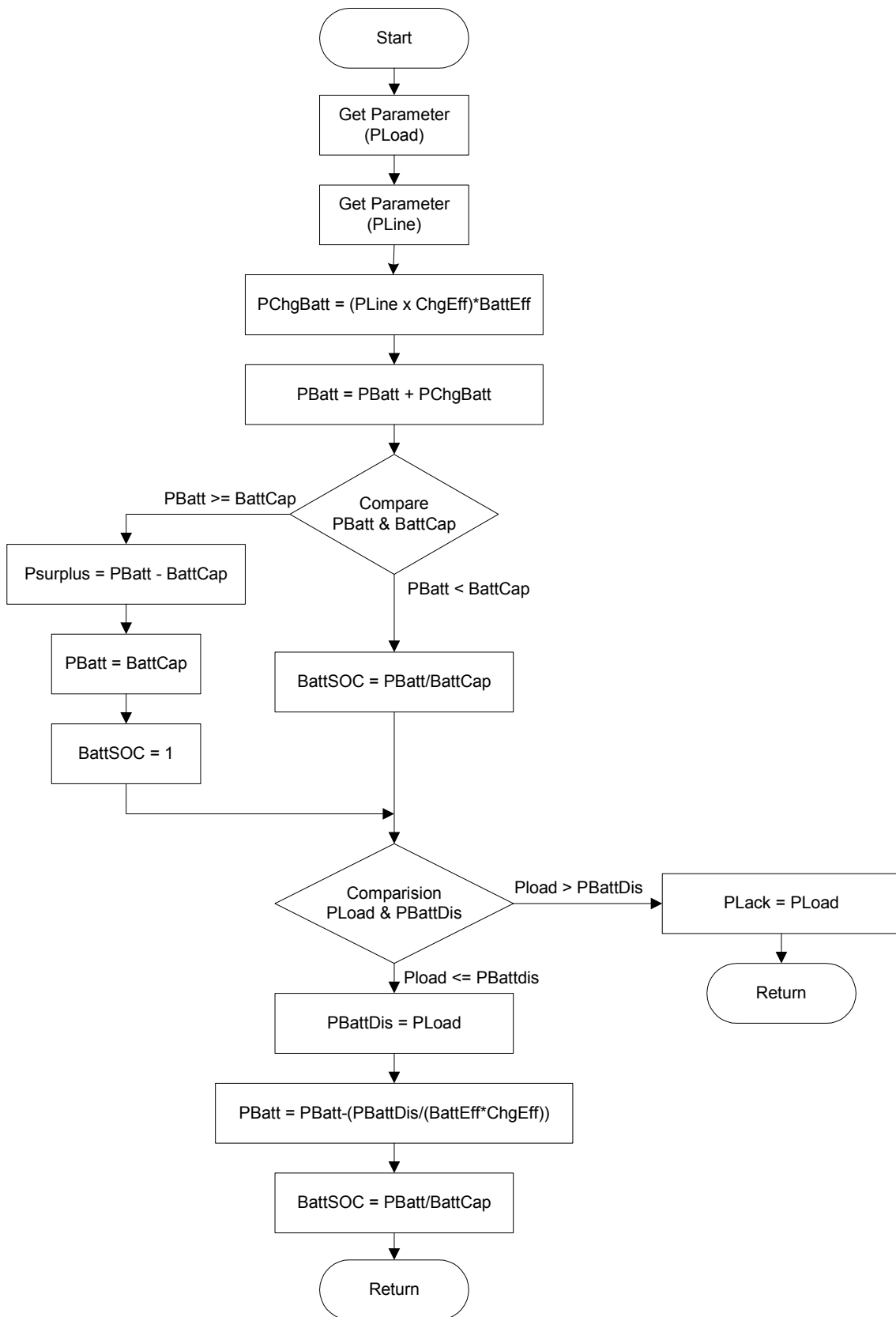
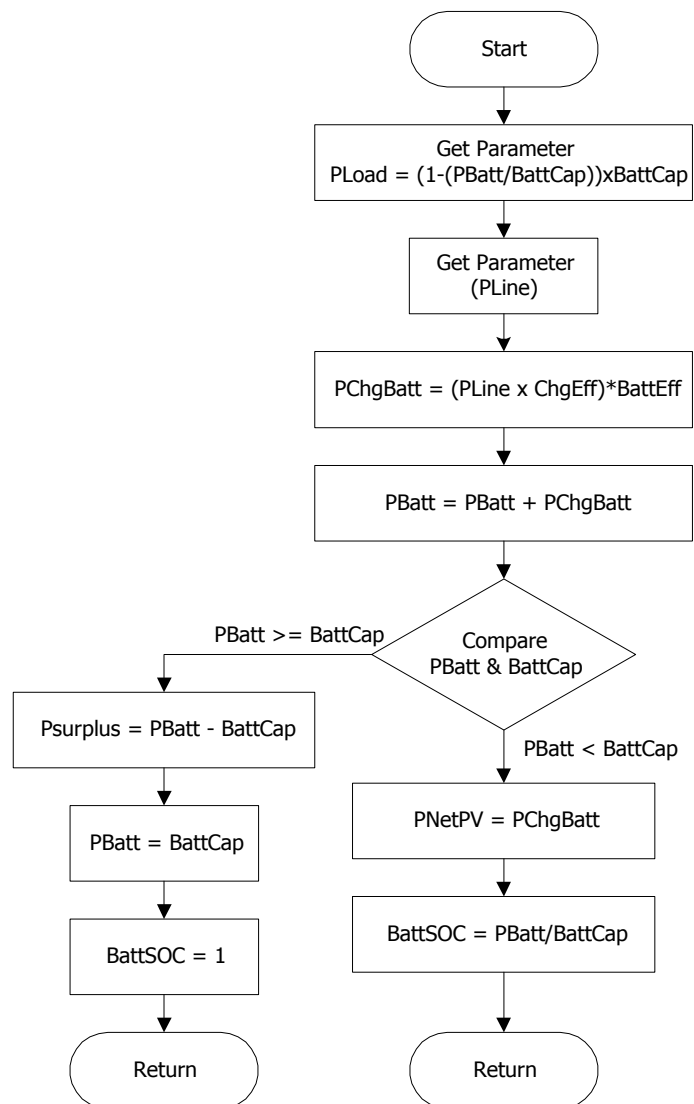

Figure 8-3: PVS algorithm

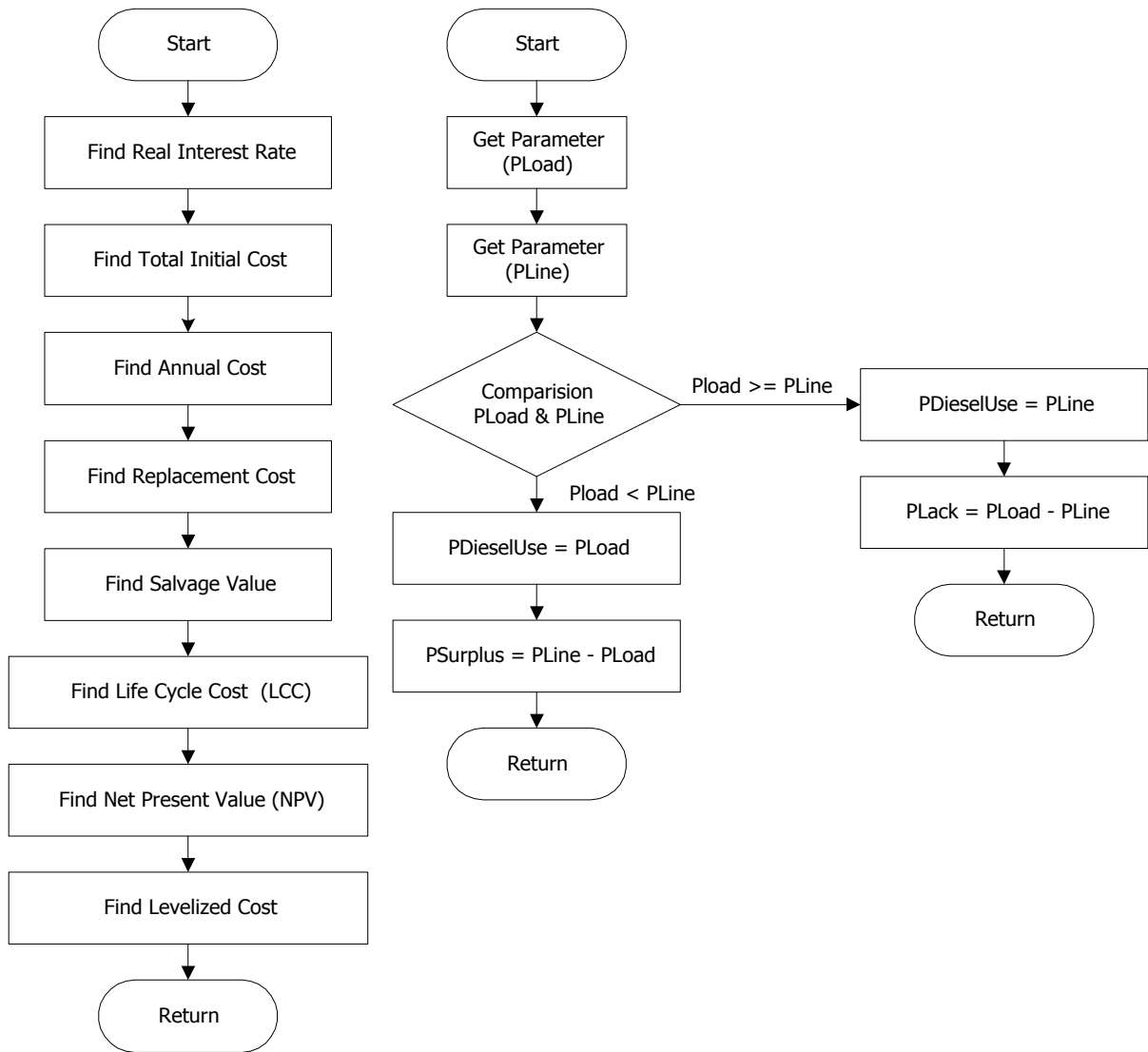



**Figure 8-4:** SHS algorithm



**Figure 8-5:** BCS algorithm



**Figure 8-6:** DGS (left) and GE (right) algorithm

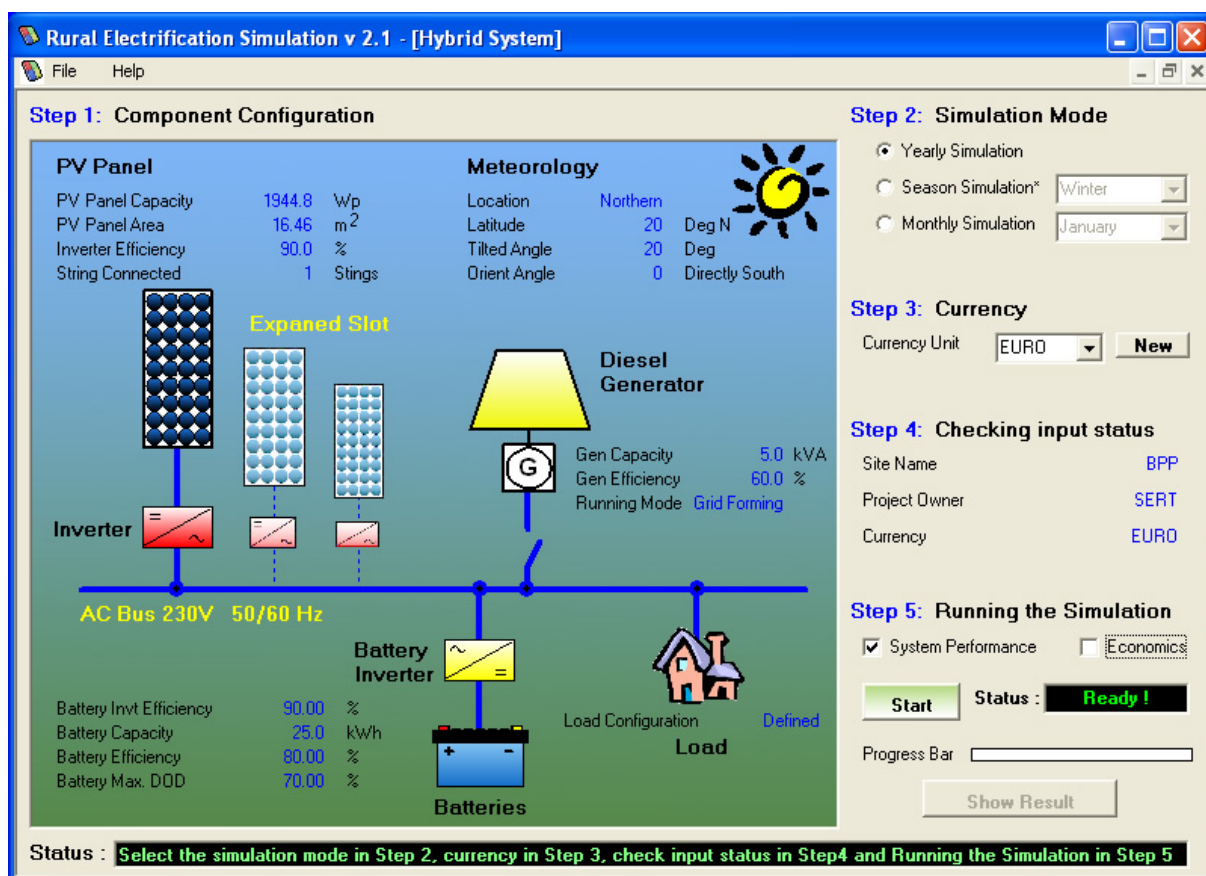

Figure 8-7: Main input user interface of PVHS

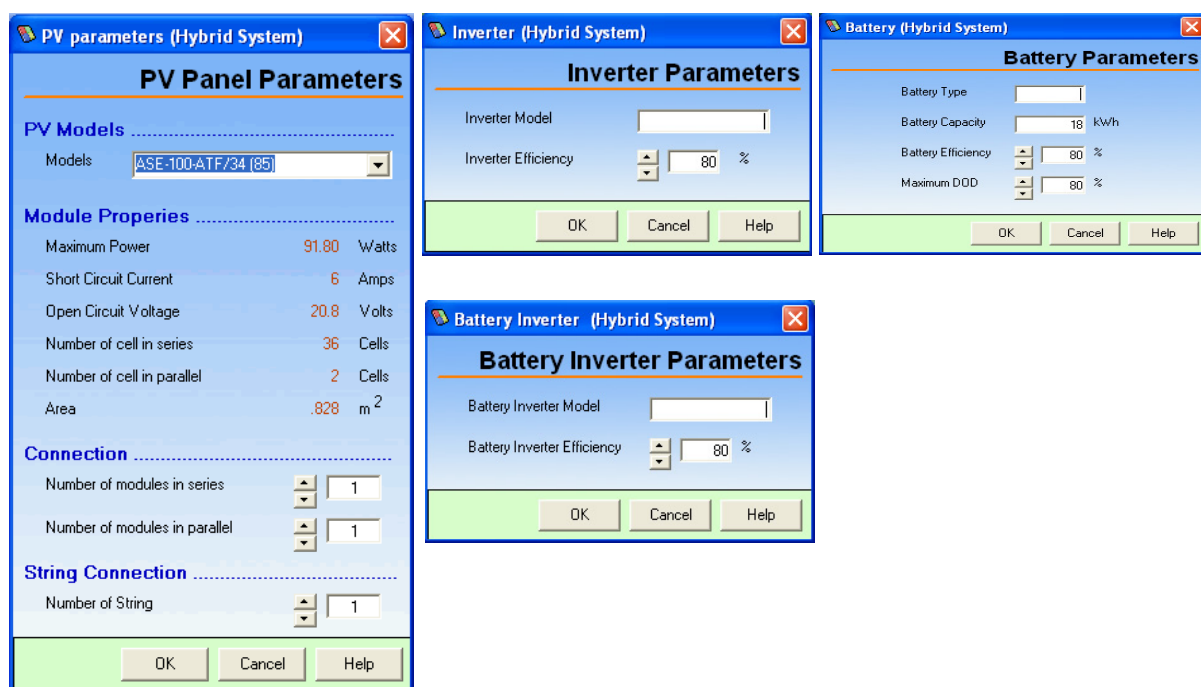

Figure 8-8: Example of Input data of PV panel, inverter and battery inverter

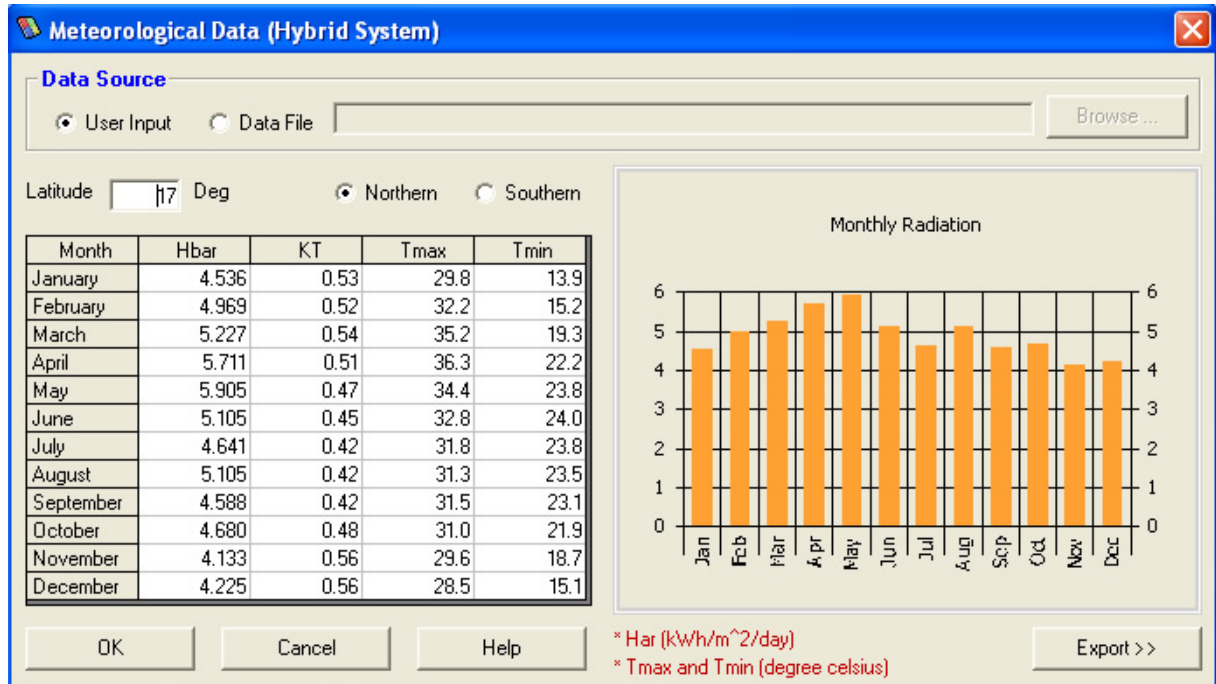

Figure 8-9: Solar radiation input user interface

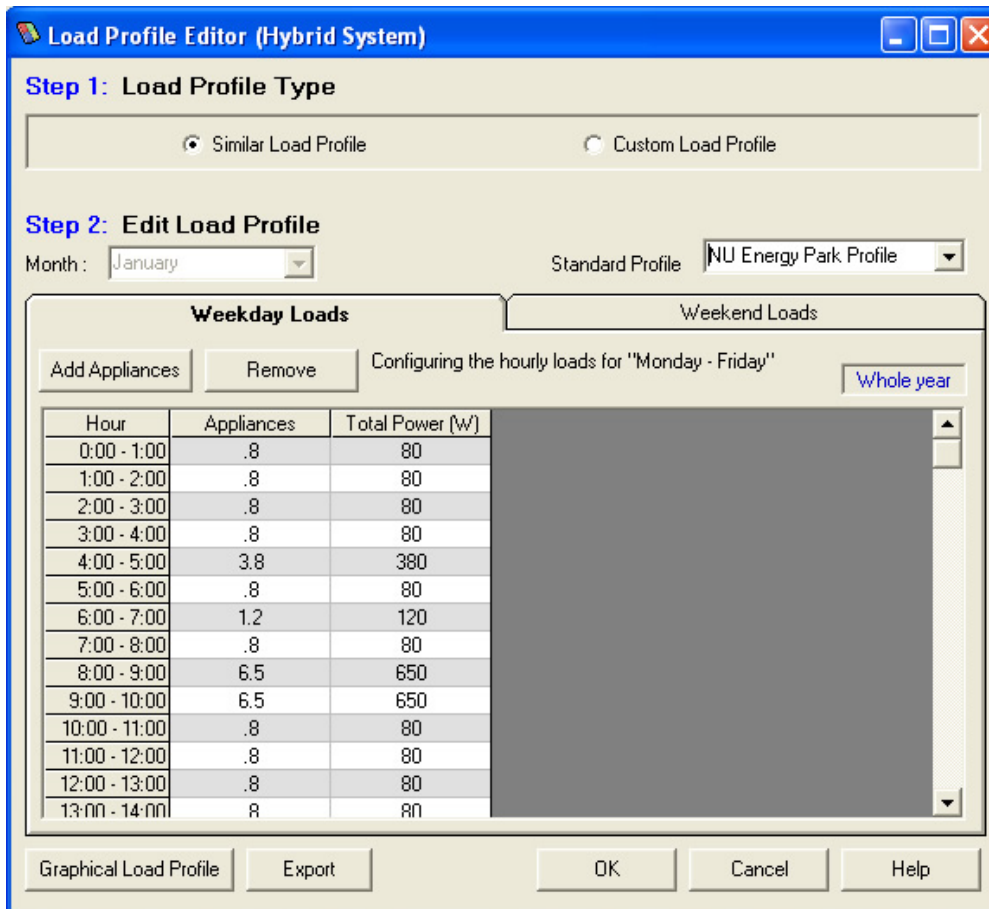

Figure 8-10: Load input user interface

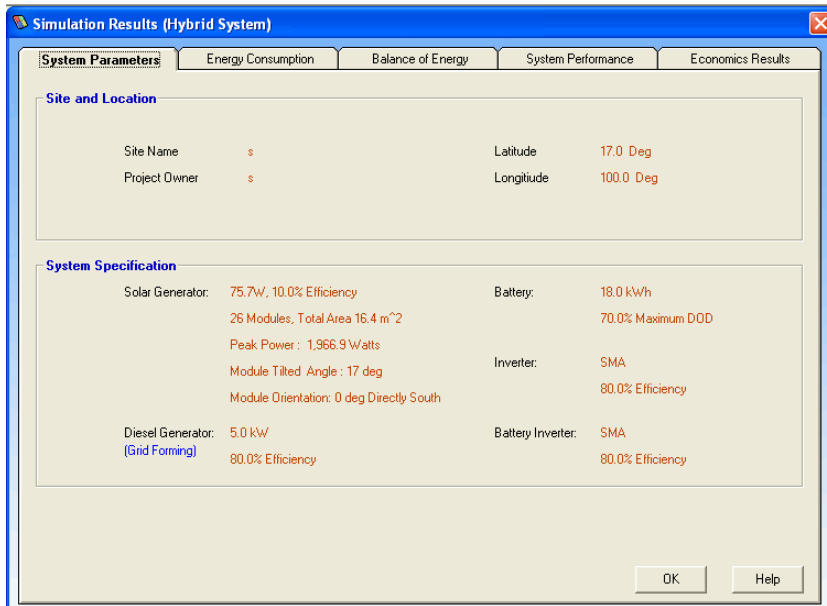

Figure 8-11: System parameter result interface

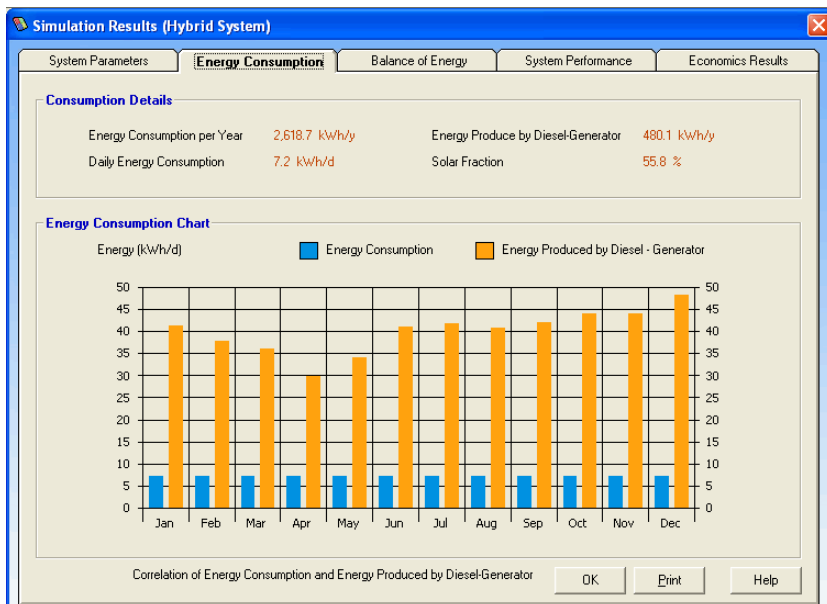

Figure 8-12: Energy consumption result interface

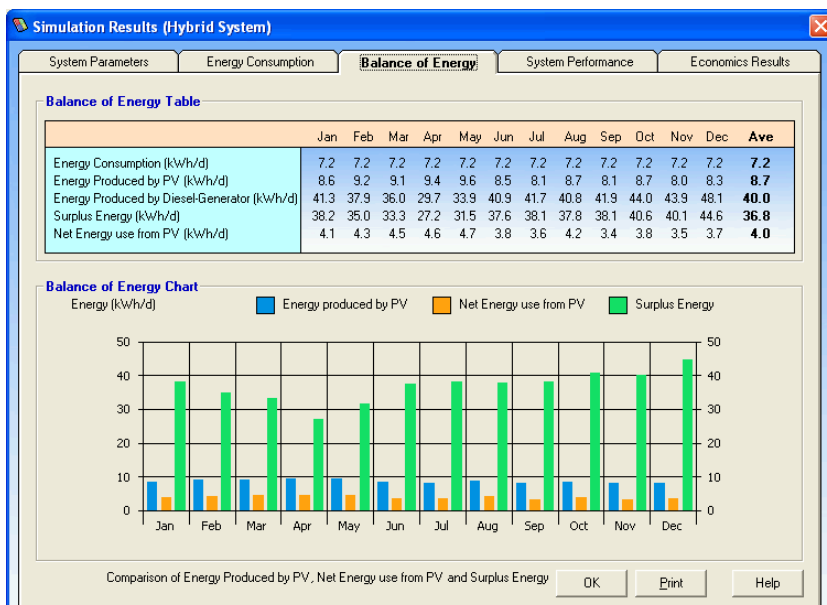

Figure 8-13: Balance of energy result interface

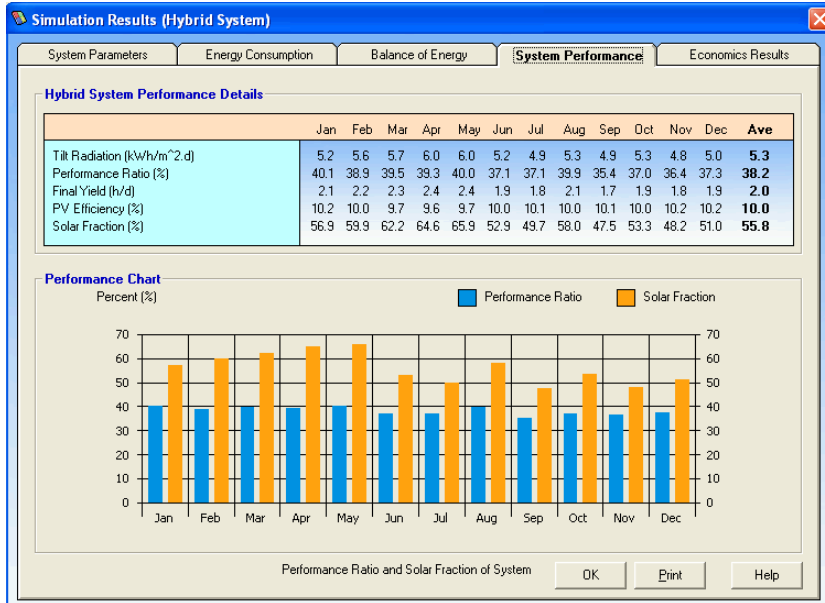

Figure 8-14: System performance result interface

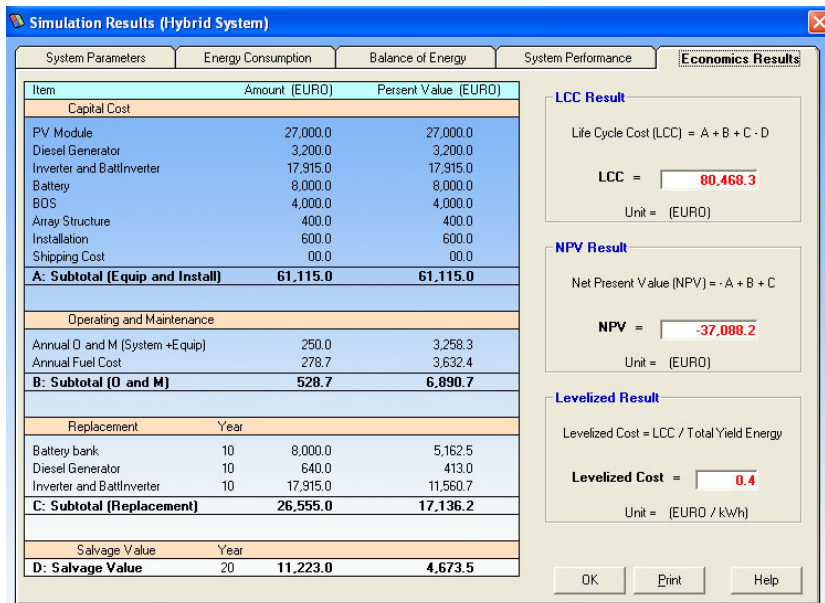

Figure 8-15: Economics result interface